

# Introduction

**Meltric Overview** ..... pg 3

**Product Features & Benefits** ..... pg 5

**Product Summary & Selection Guide** ..... pg 9



## Switch Rated Plugs & Receptacles

**DECONTACTOR™ Series – The Main Differences** ..... pg 15

**DECONTACTOR™ Selection Guide** ..... pg 19

**DSN**  
NEMA 4X rated devices, available with poly casings  
From 20 – 60A (1/2 – 20 hp) ..... pg 21

**DS**  
NEMA 3R rated, available in metal or poly  
From 20A – 200A (1/2 – 25 hp) ..... pg 33

**DB**  
IP67 rated, available with metal casings  
From 30 – 100A (1 1/2 – 60 hp) ..... pg 51



## Hazardous Duty Rated Plugs & Receptacles

**Hazardous Duty Selection Guide** ..... pg 65

**DXN**  
CSA and ATEX rated, available in poly  
From 20 – 60A ..... pg 67

**DX Plugs & Receptacles**  
ATEX rated, metallic devices  
From 20A – 100A ..... pg 79



## Multipin Plugs & Receptacles

**Multipin Plugs & Receptacles**  
4 – 37 pin connectors in poly and metal  
From 2 – 100A ..... pg 89





# Standard Duty Plugs & Receptacles

## PF / PFQ High Amperage Connectors

IP66 + 67 rated, metal construction  
From 300A – 600A

pg 119

## SP Connectors

Single Pole, high amperage connectors up to 700A, 1000 VAC

pg 125

## DR Plugs & Receptacles

NEMA 3R rated, available in poly or metal  
From 30 – 250A

pg 129

## PN Connectors

IP66 + 67 rated or IP54 rated, poly (standard duty) or metal (high temp)  
From 20 – 30A

pg 145

# Specialty Products

## Custom Power Distribution Solutions

Built to specific customer needs featuring Meltric devices

pg 157

## Safety Switch/Receptacle Combinations

pg 159

## WS – Welding Connectors

Single pole connectors for low voltage applications (max 50VAC)  
Up to 325A

pg 161

## LC – Battery Connectors

For battery charging and interconnect  
From 75A to 200A

pg 162

## Adapter Plates

For converting existing receptacles to Meltric

pg 163

## Cord Grips

pg 167

## Voltage /Phase Rotation Meter Assemblies

pg 169

# Reference

## Accessories & Options

Detailed information

pg 171

## Technical Information

Chemical and mechanical resistance, environmental ratings, electrical testing and ratings information, keying positions, and more

pg 181

## Index

Suffix Index, Parts Index and Literature order form

pg 197

# Meltric Corporation

## The best in industrial wiring devices

Safety  
Reliability  
Service  
Value

At Meltric Corporation, our only business is electrical plugs and receptacles. We are focused on providing our customers with the best overall value by offering the safest, highest quality and most reliable plugs and receptacles, and by backing them with outstanding service and support.



Meltric ships  
90% of its orders  
on the next  
business day

### Product Technology & Safety

The technology behind Meltric's products was developed specifically to address the shortcomings and safety hazards common with pin & sleeve type plugs and receptacles. In 1952, following the observation of an accident with a pin and sleeve device, Gilles Marechal devised the concept of combining the advantages of silver-nickel butt contacts and the load making and breaking capabilities of a switch with the convenience of a plug and receptacle. Shortly thereafter, the first of these products was born. Meltric licensed this technology in the early 1980's and has been supplying its products to North American customers ever since.

Today, after constant advancement of this same basic technology, Meltric products continue to provide unparalleled levels of safety and performance. Meltric's DECONTACTOR™ Series are the world's only UL, CSA and IEC switch rated plugs and receptacles. Meltric products incorporate some or all of the following unique features, not found on pin and sleeve devices, which help to ensure user safety and improve electrical performance and reliability:

- ▼ Spring-Loaded Butt Contacts
- ▼ Solid Silver-Nickel Contact Material
- ▼ Dead Front Construction
- ▼ Enclosed Arc Chambers
- ▼ Push Button Circuit Disconnection
- ▼ Internal Operating Mechanisms
- ▼ Auxiliary Contacts
- ▼ Automatic Watertightness
- ▼ Spring-Assisted Terminals
- ▼ Stainless Steel Springs and Screws



See pages 5 - 8 for a more detailed description of these features and the associated benefits.

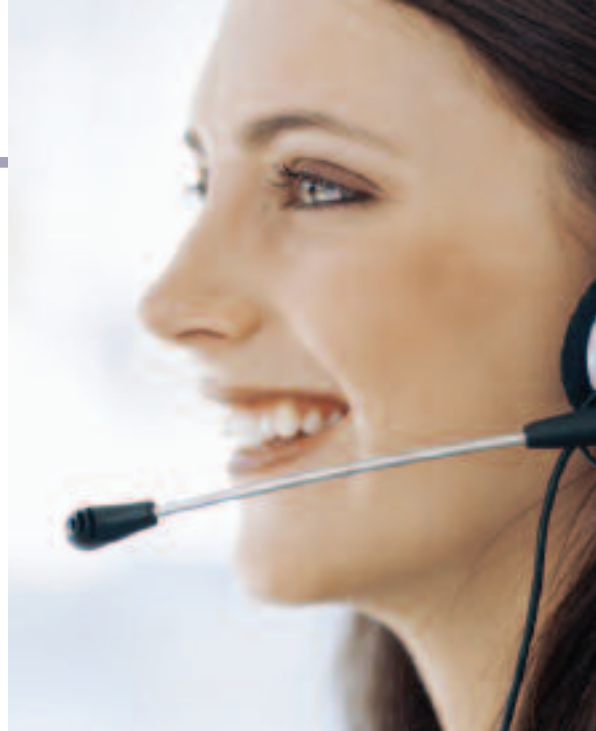

## Service & Support

Meltric backs its superior products with outstanding service and support. A network of 100 sales associates and over 1000 distributor locations across the US and Canada make access to our product easy. Meltric products are available worldwide, and similar products are produced by other butt contact connector manufacturers in Germany, Australia, Mexico, France and Spain.

Meltric's Customer Service group is trained to answer most technical questions on the spot and is located at our manufacturing facility in order to help streamline the order fulfillment process. Our engineering team stands ready to provide both application support and custom designed products incorporating Meltric and third party components into power distribution products tailored to meet your needs. Friendly and personal assistance is only a toll free call away at (800) 433-7642.

Many of Meltric's products are designed in a modular fashion, which permits cost effective stocking of components and quick final assembly of the product. Together with efficient order handling by Customer Service, this helps Meltric to provide the shortest lead times in the industry.

## Quality

Quality is not just an inspection function at Meltric. Quality starts with intelligent designs, robust materials, clear procedures, process measurement and controls and effective communications. It is completed by the care, commitment and involvement of each of our employees.

Meltric is dedicated to the continuous improvement of all its critical production and support processes and is ISO 9001:2000 certified. Meltric designs and manufactures its products to exceed the requirements of applicable UL, CSA and IEC standards. In addition, as a member of the Butt contact Electrical Connectors Manufacturers' Association (BECMA), Meltric manufactures its products in accordance with industry quality and standardization requirements in order to ensure that its products will connect and perform properly with appropriately rated butt contact connectors produced by other manufacturers.

## Value

With their unique features and capabilities, Meltric products provide users with a safer and more reliable product than competitive pin and sleeve devices. Meltric's butt style contacts provide longer operating lives, optional integral pilot contacts reduce the need for additional connectors and our switch rated Deconnectors can eliminate the need for auxiliary interlocks and disconnect switches, helping users reduce equipment costs. These advantages, together with competitive pricing, short lead times, and 5-year warranty on electrical contacts, make Meltric's products the best overall value in the plug & receptacle/connector market.



# Meltric Product Features...

## Spring-Loaded Butt Contacts

Meltric products feature spring-loaded butt contacts similar to those used in contactors and switchgear. These contacts have numerous advantages, which help improve electrical performance and user safety relative to pin and sleeve contacts or the arcuate contacts used in twist-type devices.

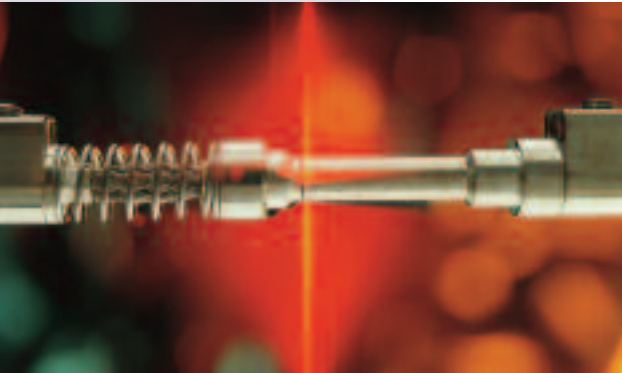

Butt style contacts ensure a very positive and consistent connection. The spring loading of these contacts, which is accomplished with coil springs, provides a desirably high contact force that remains constant over thousands of operations. In addition, it automatically compensates for any wear and/or deviations in contact length resulting from manufacturing tolerances.

This is a critical point, as contact force is a key determinant of the quality of a contact. As the accompanying chart demonstrates, contact resistance increases as contact force is reduced. Higher contact resistance generates more heat and oxidation, both of which contribute to the deterioration of the contact. This is a problem with pin and sleeve and arcuate type contacts because their contact force varies with manufacturing tolerances and is reduced due to wear that occurs with normal use.

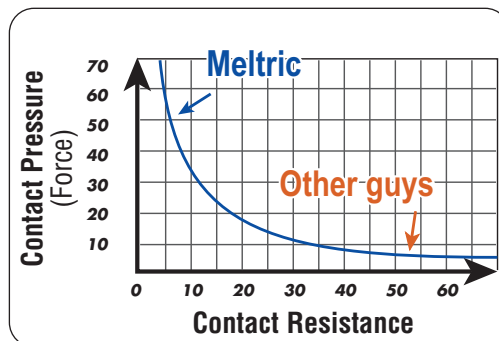

Meltric contacts close with a self-cleaning wiping action. When the contacts initially mate, they are slightly offset. In completing the connection, the plug contacts are rotated across the receptacle contacts, helping to remove deposits from the contact surfaces.

In conjunction with the spring-loaded casings used on many Meltric products, the spring-loaded contacts ensure a quick breaking of the connection that is independent of the motion of the user. By contrast, the disconnection speed of pin and sleeve and twist-type devices is dependent upon the motion of the user.

# ...and Benefits

## Silver-Nickel Contact Material

Meltric uses solid silver-nickel (85%/15%) contacts. The silver-nickel material has significant advantages over the brass contacts commonly used on competitive devices.

Silver has very low initial contact resistance and is not negatively affected by oxidation. This helps to give it excellent electrical properties that are maintained even at high temperatures and after tarnishing. Nickel is a much harder material and contributes excellent mechanical properties. The combination of silver and nickel results in a contact material that has both superior electrical capabilities and excellent resistance to wear. Silver-nickel only welds at extremely high pressure and temperature, and thus, also withstands arcs very well. These features make silver-nickel a commonly used contact material by switchgear manufacturers.

MATERIAL	CONTACT	RESISTANCE
	New	Oxidized
SILVER	6 $\mu\Omega$	25 $\mu\Omega$
SILVER-NICKEL	23 $\mu\Omega$	60 $\mu\Omega$
COPPER	29 $\mu\Omega$	400 $\mu\Omega$
BRASS	370 $\mu\Omega$	1400 $\mu\Omega$



By contrast, the brass material used in most competitive plug and receptacles has much higher initial contact resistance and is negatively affected by oxidation. In an oxidized state, the contact resistance of brass is more than 20 times higher than that of silver-nickel. In addition, brass is a soft material that wears rapidly. In use, brass pin and sleeve and arcuate contacts suffer from the combined effects of the limitations of the material and the design. As oxidation and wear induced reductions in contact force occur, contact resistance increases. This increases operating temperature, which causes further oxidation and wear, perpetuating a vicious cycle of degradation. Brass is not arc resistant and is not suitable for making and breaking under load.

## Dead Front Construction

Most Meltric products feature dead front construction, which greatly enhances safety by eliminating any unintended access to live parts. On most Meltric products, the dead front is accomplished with a safety shutter that can be opened only by an appropriate mating plug. The live receptacle contacts can only be accessed by the plug, after its insertion into the receptacle. The design of the product also ensures that the plug contacts are dead before the user can remove the plug from the receptacle.

By contrast, pin and sleeve and twist-type devices do not have dead front construction. Access to live receptacle contacts is possible, and on some devices the plug contacts may be live and accessible when the plug is being removed.



# Meltric Product Features...

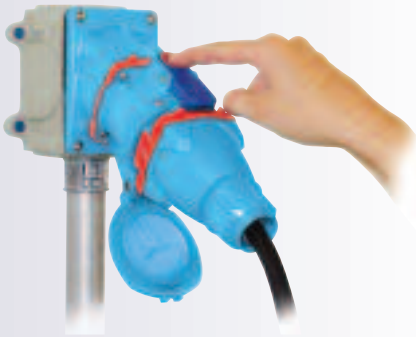

## Push Button Circuit Disconnection

To disconnect most Meltric products, the user simply needs to depress the pawl. This causes the circuit to be disconnected and the plug to be ejected to its rest (off) position in the receptacle. If desired, the user can then remove the plug from the receptacle by rotating it slightly and then withdrawing it. This mode of operation ensures that it is only possible to remove the plug after its contacts have been deenergized.

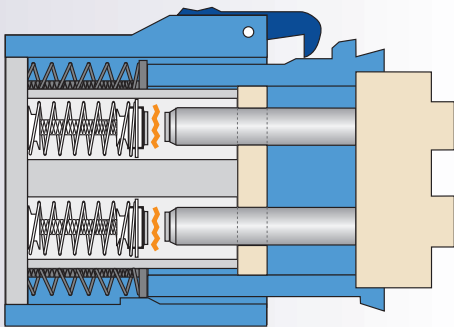

## Enclosed Arc Chambers

The contacts on most Meltric products make and break within enclosed arc chambers. This ensures that the arcing which normally occurs during the making and breaking of the contacts is contained inside the device. This greatly enhances safety and avoids potential injury to users and/or harm to the outside environment.

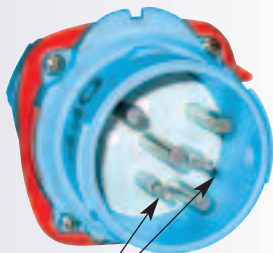

Auxiliary/Pilot Contacts

## Optional Auxiliary / Pilot Contacts

Many Meltric products are available with optional auxiliary/pilot contacts. These integral pilot contacts allow users the convenience and flexibility of controlling auxiliary equipment, monitoring parameters (such as motor temperature), and/or communicating alarms through the same plug and receptacle used to supply power to the equipment. Because the pilot contacts are integral, they also facilitate the rapid change-out or reconfiguration of equipment by eliminating the need for hard wiring or multiple plug connections.

## Automatic Watertightness

On most pin and sleeve devices, an additional plastic ring must be tightened in order to ensure the achievement of rated watertightness. Users frequently fail to do this, resulting in leakage. Meltric solves this problem with its DS and DSN DECONTACTOR™ Series plugs and receptacles, which achieve their rated watertightness of up to NEMA 4X simply by mating the plug with the receptacle. After the removal of the plug, rated watertightness is maintained for the receptacle by simply closing the lid.



# ...and Benefits

## Spring-Assisted Terminals

The loosening of terminal screws is a common cause for failure on standard plugs and receptacles. Meltric provides a more permanent and secure connection with its unique and patented spring-assisted terminal design.

As the terminal screw is tightened against the conductor, the associated pressure expands the split terminal body, causing a spring ring surrounding the terminal to deform into an elliptical shape. The natural tendency for the spring ring to return to its original size and shape ensures that a constant pressure is maintained on the conductor. This allows the terminal to effectively compensate for strand settlement and conductor yield, due to cold flow of the material, and provides superior resistance to vibration, shock and thermal cycling.

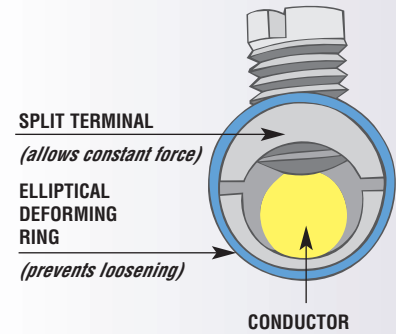

## Lockout-Tagout Capability

Most Meltric plugs and receptacles facilitate compliance with OSHA lockout-tagout requirements. Only a lock and tag are needed to ensure that the plug is properly locked out and tagged out – no additional mechanisms are required. Meltric devices feature a lockout provision that is integral to the device – it is always available when you need it. On most models the lockout provision is a simple 5/16” hole in the plug shroud that facilitates the insertion of a typical padlock which prevents the plug from being inserted into a receptacle. An optional provision for locking out Meltric receptacles is also available. In most cases this is accomplished via a specially machined hole at the receptacle pawl which allows insertion of a padlock to secure the receptacle lid in a closed position. This same optional provision can be used to prevent removal of the plug if desired.



By comparison, in order to lockout most competitive pin and sleeve type plugs, an additional third-party 'lockout shield' or 'plug cap' is required. These devices can be expensive and are often times lost, broken, or not available when you need them.



## Modular Construction

Due to the robust construction of Meltric devices the need to replace worn parts is rare. However, should they be required, parts are readily available and reasonably priced. The modular construction of most Meltric devices enables easy replacement of parts in the field.





# Meltric Product Summary and Selection Guide

	Model	Amp Rating	Maximum Voltage Rating		Environmental Ratings		Available Casing Materials			Maximum Number of Contacts	
			VAC	VDC	NEMA	IP	Poly	Metal	SS	Main	Auxiliary
<b>Decontactors</b> 	<b>DSN20</b>	20	480	–	4X	66 + 67	Poly	–	–	3P+N+E	–
	<b>DSN30</b>	30	600	250	4X	66 + 67	Poly	–	–	3P+N+E	2
	<b>DSN60</b>	60	600	250	4X	66 + 67	Poly	–	–	3P+N+E	4
	<b>DS20</b>	20	600	250	3R	54/55	Poly	–	SS**	3P+N+E	2
	<b>DS30</b>	30	600	250	3R	54/55	Poly	–	SS**	3P+N+E	4
	<b>DS60</b>	60	600	250	3R	54/55	Poly	Metal	–	3P+N+E	3
	<b>DS100C</b>	100	600	250	3R	54/55	Poly	Metal	–	3P+N+E	3
	<b>DS100</b>	100	600	250	3R	54/55	Poly	Metal	–	3P+N+E	5
	<b>DS200</b>	200	480	–	3R	54/55	–	Metal	–	3P+N+E	5
	<b>DB30</b>	30	600	250	–	67	–	Metal	–	3P+N+E	2
<b>DB60</b>	60	600	250	–	67	–	Metal	–	3P+N+E	2	
<b>DB100</b>	100	600	250	–	67	–	Metal	–	3P+N+E	4	
<b>Hazardous Duty</b> 	<b>DXN20</b>	20	480	250	4X	66 + 67	Poly	–	–	3P+N+E	–
	<b>DXN30</b>	30	600	250	4X	66 + 67	Poly	–	–	3P+N+E	2
	<b>DXN60</b>	60	600	250	4X	66 + 67	Poly	–	–	3P+N+E	2
	<b>DX20</b>	20	480	–	–	65	–	Metal	–	3P+N+E	–
	<b>DX30</b>	30	480	–	–	65	–	Metal	–	3P+N+E	–
	<b>DX60</b>	60	480	–	–	65	–	Metal	–	3P+N+E	–
	<b>DX100</b>	100	480	–	–	65	–	Metal	–	3P+N+E	–
<b>Multipin</b> 	<b>PN12</b>	5	600	250	4X*	66 + 67*	Poly	Metal	SS	12	–
	<b>PN12</b>	7.5	600	250	4X*	66 + 67*	Poly	Metal	SS	12	–
	<b>DSN24</b>	2	480	120	4X	66 + 67	Poly	–	–	24	–
	<b>DSN24</b>	7.5	480	120	4X	66 + 67	Poly	–	–	24	–
	<b>DS24</b>	2	250	120	3R	–	–	–	SS	24	–
	<b>DS24</b>	7.5	250	120	3R	–	–	–	SS	24	–
	<b>DSN37</b>	2	480	120	4X	66 + 67	Poly	–	–	37	–
	<b>DSN37</b>	7.5	480	120	4X	66 + 67	Poly	–	–	37	–





\* The indicated ratings do not apply to devices with SS casings

\*\* Contact Customer Service for more information

Model	Current Interruption Rating*	Horsepower Ratings (see catalog section for other voltages)			Main Contacts Wire Size Capacity		Terminal Type
		240V - 3Ø	480V - 3Ø	600V - 3Ø	Min	Max	
<b>DSN20</b>	Switch Rated	2 hp	5 hp	–	20 AWG	12 AWG	Screw
<b>DSN30</b>	Switch Rated	5 hp	10 hp	15 hp	14 AWG	8 AWG	Screw
<b>DSN60</b>	Switch Rated	7 1/2 hp	20 hp	20 hp	12 AWG	4 AWG	Screw
<b>DS20</b>	Switch Rated	1 1/2 hp	5 hp	7 1/2 hp	14 AWG	8 AWG	Screw
<b>DS30</b>	Switch Rated	3 hp	10 hp	–	12 AWG	4 AWG	Screw
<b>DS60</b>	Switch Rated	7 1/2 hp	20 hp	25 hp	6 AWG	2 AWG	Screw
<b>DS100C</b>	Switch Rated	7 1/2 hp	20 hp	25 hp	6 AWG	2 AWG	Screw
<b>DS100</b>	Switch Rated	–	–	–	4 AWG	2/0 AWG	Screw
<b>DS200</b>	Switch Rated	–	–	–	4 AWG	4/0 AWG	Screw
<b>DB30</b>	Switch Rated	7 1/2 hp	10 hp	10 hp	14 AWG	8 AWG	Screw
<b>DB60</b>	Switch Rated	15 hp	30 hp	30 hp	8 AWG	3 AWG	Screw
<b>DB100</b>	Switch Rated	30 hp	60 hp	60 hp	4 AWG	2/0 AWG	Screw
<b>DXN20</b>	Current Interrupting	–	–	–	20 AWG	10 AWG	Screw
<b>DXN30</b>	Current Interrupting	–	–	–	14 AWG	6 AWG	Screw
<b>DXN60</b>	Current Interrupting	–	–	–	10 AWG	4 AWG	Screw
<b>DX20</b>	Current Interrupting	–	–	–	14 AWG	6 AWG	Screw
<b>DX30</b>	Current Interrupting	–	–	–	14 AWG	6 AWG	Screw
<b>DX60</b>	Current Interrupting	–	–	–	8 AWG	2 AWG	Screw
<b>DX100</b>	Current Interrupting	–	–	–	4 AWG	2 AWG	Screw
<b>PN12</b>	Current Interrupting	–	–	–	20 AWG	14 AWG	Solder
<b>PN12</b>	Non-Current Interrupting	–	–	–	20 AWG	14 AWG	Solder
<b>DSN24</b>	Current Interrupting	–	–	–	20 AWG	14 AWG	Solder
<b>DSN24</b>	Non-Current Interrupting	–	–	–	20 AWG	14 AWG	Solder
<b>DS24</b>	Current Interrupting	–	–	–	20 AWG	14 AWG	Solder
<b>DS24</b>	Non-Current Interrupting	–	–	–	20 AWG	14 AWG	Solder
<b>DSN37</b>	Current Interrupting	–	–	–	20 AWG	14 AWG	Solder
<b>DSN37</b>	Non-Current Interrupting	–	–	–	20 AWG	14 AWG	Solder

\* Switch ratings apply to alternating current only

# Meltric Product Summary and Selection Guide

	Model	Amp Rating	Maximum Voltage Rating		Environmental Ratings		Available Casing Materials			Maximum Number of Contacts		
			VAC	VDC	NEMA	IP	Poly	Metal	SS	Main	Auxiliary	
 <b>Multipin</b>	<b>DS37</b>	2	480	120	4X	–	–	–	SS	37	–	
	<b>DS37</b>	7.5	480	120	4X	–	–	–	SS	37	–	
	<b>PN7</b>	15	600	250	4X*	66 + 67*	Poly	Metal	SS	7	–	
	<b>PN7</b>	20	600	250	4X*	66 + 67*	Poly	Metal	SS	7	–	
	<b>DN9</b>	20	480	120	–	54/55	–	Metal	–	9	–	
	<b>DN20</b>	20	480	120	–	54/55	–	Metal	–	20	–	
	<b>DN7</b>	50	480	120	–	54/55	–	Metal	–	6P+E	–	
	<b>DN7</b>	90	480	120	–	54/55	–	Metal	–	6P+E	–	
	<b>DN7</b>	150	480	120	–	54/55	–	Metal	–	6P+E	–	
	<b>DS7</b>	30	600	120	–	54/55	Poly	Metal	–	7	3	
<b>DR7</b>	50	600	120	–	54/55	Poly	Metal	–	7	3		
 <b>Standard</b>	<b>PFQ</b>	300	600	250	–	66 + 67	–	Metal	–	3P+N+E	8	
	<b>PF300</b>	300	600	250	–	66 + 67	–	Metal	–	3P+N+E	4	
	<b>PF400</b>	400	600	250	–	66 + 67	–	Metal	–	3P+N+E	4	
	<b>PF600</b>	600	600	250	–	66 + 67	–	Metal	–	3P+N+E	4	
		<b>SP</b>	700	1000	1500	–	66 + 67	Poly	–	–	1P	–
	<b>PN</b>	20	600	250	–	54 or 66 + 67*	Poly	Metal	SS	3P+N+E	–	
		<b>PNHT</b>	20	600	250	–	44	–	Metal	–	3P+N+E	–
	<b>PNHT</b>	30	600	250	–	44	–	Metal	–	3P+N+E	–	
		<b>DR30</b>	30	600	250	3R	54/55	Poly	–	–	3P+N+E	2
	<b>DR50</b>	50	600	250	3R	54/55	Poly	–	–	3P+N+E	4	
	<b>DR100</b>	100	600	250	3R	54/55	Poly	Metal	–	3P+N+E	3	
	<b>DR150</b>	150	600	250	3R	54/55	Poly	Metal	–	3P+N+E	5	
	<b>DR250</b>	250	600	250	3R	54/55	–	Metal	–	3P+N+E	5	

\* The indicated ratings do not apply to devices with SS casings  
 † Up to 250VAC

Model	Current Interruption Rating	Horsepower Ratings <i>(see catalog section for other voltages)</i>			Main Contacts Wire Size Capacity		Terminal Type
		240V - 3Ø	480V - 3Ø	600V - 3Ø	Min	Max	
<b>DS37</b>	Current Interrupting	–	–	–	20 AWG	14 AWG	Solder
<b>DS37</b>	Non-Current Interrupting	–	–	–	20 AWG	14 AWG	Solder
<b>PN7</b>	Current Interrupting	–	–	–	18 AWG	10 AWG	Screw
<b>PN7</b>	Non-Current Interrupting	–	–	–	18 AWG	10 AWG	Screw
<b>DN9</b>	Non-Current Interrupting	–	–	–	16 AWG	10 AWG	Screw
<b>DN20</b>	Non-Current Interrupting	–	–	–	16 AWG	10 AWG	Screw
<b>DN7</b>	Non-Current Interrupting	–	–	–	10 AWG	6 AWG	Screw
<b>DN7</b>	Non-Current Interrupting	–	–	–	6 AWG	2 AWG	Screw
<b>DN7</b>	Non-Current Interrupting	–	–	–	6 AWG	2 AWG	Screw
<b>DS7</b>	Current Interrupting	–	–	–	14 AWG	8 AWG	Screw
<b>DR7</b>	Non-Current Interrupting	–	–	–	14 AWG	8 AWG	Screw
<b>PFQ</b>	Non-Current Interrupting	–	–	–	4/0 AWG	350 MCM	Lug
<b>PF300</b>	Non-Current Interrupting	–	–	–	250 MCM	600 MCM	Lug
<b>PF400</b>	Non-Current Interrupting	–	–	–	250 MCM	600 MCM	Lug
<b>PF600</b>	Non-Current Interrupting	–	–	–	250 MCM	600 MCM	Lug
<b>SP</b>	Non-Current Interrupting	–	–	–	2/0 AWG	777 MCM	Lug
<b>PN</b>	Current Interrupting	–	–	–	18 AWG	10 AWG	Screw
<b>PNHT</b>	Current Interrupting	–	–	–	18 AWG	10 AWG	Screw
<b>PNHT</b>	Non-Current Interrupting	–	–	–	18 AWG	10 AWG	Screw
<b>DR30</b>	Non-Current Interrupting	–	–	–	14 AWG	8 AWG	Screw
<b>DR50</b>	Current Interrupting <sup>1</sup>	–	–	–	12 AWG	4 AWG	Screw
<b>DR100</b>	Current Interrupting	–	–	–	6 AWG	2 AWG	Screw
<b>DR150</b>	Current Interrupting <sup>1</sup>	–	–	–	4 AWG	2/0 AWG	Screw
<b>DR250</b>	Non-Current Interrupting	–	–	–	4 AWG	4/0 AWG	Screw

# Meltric Part Numbering...



First seven (7) digits for a basic inlet or receptacle part number

One (1) to six (6) suffixes for special features

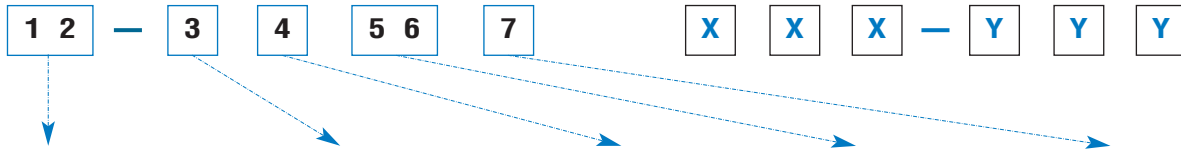

Meltric Product Line Type and Casing Material	AMP (A) Rating		Form and Mounting	Voltage Polarization			Phasing
	Position	Voltage		Hz			
<b>PN</b> <b>01</b> = Blue Poly <b>09</b> = Blue Metal  <b>DN</b> <b>19</b> = Blue Metal <b>39</b> = Blue Metal  <b>DXN</b> <b>22</b> = Black Poly  <b>DX</b> <b>26</b> = Gray Metal  <b>DS</b> <b>33</b> = Blue Poly <b>35</b> = Black Poly <b>37</b> = Blue Metal  <b>DR</b> <b>31</b> = Blue Poly <b>35</b> = Black Poly <b>39</b> = Blue Metal  <b>PF</b> <b>49</b> = Gray Metal  <b>PFQ</b> <b>47</b> = Gray Metal  <b>DSN</b> <b>63</b> = Blue Poly <b>65</b> = Black Poly  <b>DB</b> <b>89</b> = Blue Metal	<b>PN</b> <b>N</b> = 20 (IP66+67) <b>S</b> = 20 (IP54/55) <b>2</b> = 20 <b>3</b> = 30  <b>DN</b> <b>1</b> = 20* <b>3</b> = 50* <b>6</b> = 90* <b>9</b> = 150*  <b>DXN</b> <b>1</b> = 20 <b>3</b> = 30 <b>6</b> = 60  <b>DX</b> <b>2</b> = 20 <b>3</b> = 30 <b>6</b> = 60 <b>9</b> = 100  <b>DS</b> <b>1</b> = 20 <b>3</b> = 30 <b>6</b> = 60 <b>9</b> = 100  * Available in metal only	<b>DR</b> <b>1</b> = 30 <b>3</b> = 50 <b>6</b> = 100 <b>9</b> = 150 <b>2</b> = 250*  <b>PF</b> <b>3</b> = 300* <b>4</b> = 400* <b>6</b> = 600*  <b>PFQ</b> <b>3</b> = 300*  <b>DSN</b> <b>1</b> = 20 <b>3</b> = 30 <b>6</b> = 60  <b>DB</b> <b>3</b> = 30* <b>6</b> = 60* <b>9</b> = 100*	<b>Female</b> <b>4</b> = Receptacle  <b>Male</b> <b>8</b> = Inlet  <b>DX Only</b> <b>Female</b> <b>0</b> = Receptacle on box <b>3</b> = Connector <b>4</b> = Receptacle  <b>Male</b> <b>1</b> = Plug <b>6</b> = Inlet on Box	<b>01</b> = 220 / 250 380 / 440 <b>02</b> = 20 / 24 <b>03</b> = 110 / 130 190 / 230 <b>04</b> = 255 / 277 440 / 480 <b>06</b> = 25 / 28 <b>07</b> = 110 / 125 220 / 250 <b>08</b> = 20 / 24 <b>09</b> = 480 / 500 <b>10</b> = 110 / 130 <b>11</b> = 115 / 127 200 / 220 <b>12</b> = 115 / 127 200 / 220 <b>13</b> = 40 / 48 <b>14</b> = 347 / 600 <b>16</b> = 120 / 127 208 / 220 <b>17*</b> = 110 / 125 220 / 250 <b>18*</b> = 347 / 600 <b>19</b> = 380 / 440 660 / 690 <b>20</b> = 220 / 250 <b>22</b> = 1000 <b>23*</b> = 120 / 127 208 / 220 <b>24*</b> = 255 / 277 440 / 480  * For DS100C and DR devices	<b>AC</b> <b>2</b> = 2P+E AC <b>3</b> = 3P+E AC <b>5</b> = 1P+N+E AC <b>6</b> = 2P+N+E AC <b>7</b> = 3P+N+E AC <b>A+</b> = 2P AC <b>B+</b> = 3P AC <b>C+</b> = 3P+N AC <b>D+</b> = 1P+N AC <b>G</b> = 2P+N AC  <b>DC</b> <b>9</b> = 2P+E DC <b>Z*</b> = 2P DC  * For 50V or less only		

**Note:** On metal devices, plugs are not painted, receptacles are painted.

**Note:** This is the Keying Standard for Meltric products. Suffixes are available to accommodate non-interchangeable devices of the same size at the same voltage. Please ask for more details.

# ...and Ordering Guide



## A MODULAR SYSTEM

Meltric products are ordered and assembled in a modular fashion. Customers should select the desired male inlet and female receptacle part numbers. Then matching accessories such as handles, angles, and junction boxes should be identified and added to the order to create plugs, connectors, or other configurations. This modular system allows Meltric to build and ship product to customer specifications in a very short time - 90% of orders ship by the next business day.

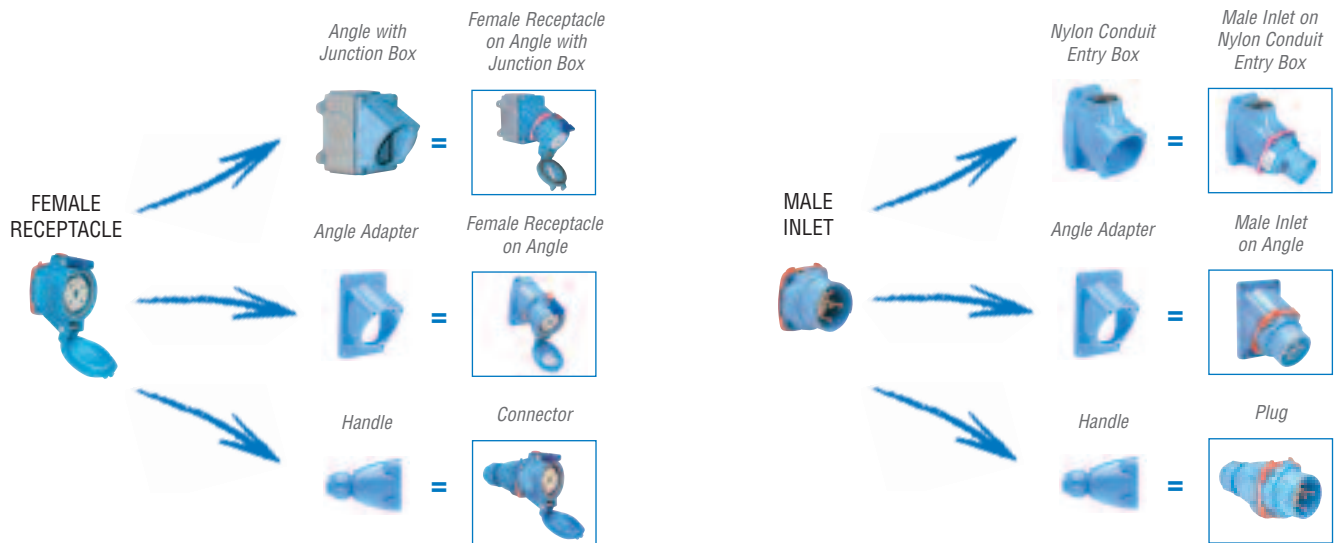



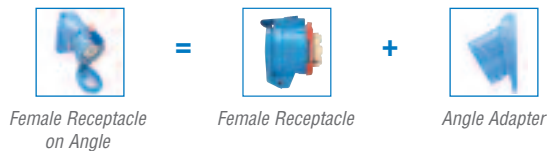

### EXAMPLE

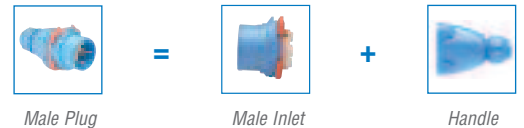

### EXAMPLE



### TYPICAL ORDER

-  63-34047 Female Receptacle
-  61-3A027 Angle Adapter for Female
-  63-38047 Male Inlet
-  61-3A013 Handle for Male

# DECONTACTOR™ Series Switch Rated Plugs & Receptacles

## The Main Differences



Pressing the pawl/button on the receptacle will safely switch off the DECONTACTOR. The plug can then be withdrawn in complete safety. (Cutaway model shown for illustration purposes)

### Like most Meltric products Decontactors feature (see pages 6-8)

- ▼ Spring-loaded butt contacts
- ▼ Silver-nickel contact materials
- ▼ Dead front construction
- ▼ Enclosed arc chambers
- ▼ Spring assisted terminals
- ▼ Auxiliary contacts

### Only DECONTACTOR™ products also feature:

- ▼ UL & CSA switch ratings
- ▼ Horsepower ratings
- ▼ Short circuit ratings up to 100 kA in fuse protected circuits

## Switch and Hp Ratings

Decontactors are a combination plug, receptacle and disconnect switch in the same device. The Decontactors integral switch technology ensures the safe breaking of resistive and inductive loads (up to 60 hp or 200A) before the plug can be removed from the receptacle.

Decontactors are UL and CSA approved for both “branch circuit” and “motor circuit” disconnect switching, so they are ideal for connecting motors, welding machines and virtually any other electrical equipment.



To match the functionality of a DECONTACTOR, it would take a pin and sleeve plug with mechanical interlock plus a non-fused safety switch.

## Short Circuit Ratings

Decontactors help ensure worker safety even in fault conditions. All Decontactors are rated to close into and withstand short circuit currents of 65 kA to 100 kA. The protection far surpasses that offered by other plugs and receptacles, and even surpasses the short circuit protection offered by most manual motor controllers and mechanical interlocks.



Don't let this happen to you!  
Pin and sleeve devices are not safe to make and break under load - Meltric Decontactors are.

## UL & CSA Standards

### Test requirements and ratings comparison table

To attain their switch ratings, DECONTACTOR™ Series plugs and receptacles passed electrical and mechanical endurance tests, horsepower/locked rotor overload tests, and short circuit make and withstand tests that far exceed the tests passed by ordinary plugs and receptacles. In fact, the tests performed to achieve the Decontactor's switch ratings are the same electrical performance tests required of manual motor controllers and enclosed disconnect switches (UL 508 and UL 98 type devices).

The chart below compares the test requirements for achieving a Switch Rated Plug & Receptacle listing with those required for a standard pin and sleeve type plug & receptacle listing.

Test	UL 1682 & CSA 22.2 No. 182.1		UL Subject 2682 (used for both UL & CSA listings)
	Plugs, Receptacles & Cable Connectors of the Pin & Sleeve Type		Switch Rated Plugs & Receptacles
	Non-Current Interrupting Break	Current Interrupting	Motor Circuit/Branch Circuit Switching
Temperature Rise	< 30°C	< 30°C	< 30°C
Voltage Withstand	1000V + 200% of Device Rating	1000V + 200% of Device Rating	1000V + 200% of Device Rating
Overload General Use Devices	3 Operations @ 150% of Rated Current (p.f. = .75 - .80)	50 Operations @ 150% of Rated Current (p.f. = .75 - .80)	50 Operations @ 150% of Rated Current (p.f. = .75 - .80)
Mechanical Endurance (Plus Req'd Electrical Opns)	15-20A = 5000 Opns 21-63A = 2000 Opns 64-250A = 250 Opns	15-20A = 0 Opns 21-63A = 1000 Opns 64-250A = 500 Opns	covered by Electrical Endurance test
Electrical Endurance (With Load)	–	15-20A = 5000 Opns 21-63A = 1000 Opns <sup>1</sup> 64-250A = 250 Opns <sup>1</sup> @ Rated Current & Voltage (p.f. = .75 - .80)	6000 Cycles @ Rated Current & Voltage (p.f. = .75 - .80)
Overload - Locked Rotor (Horsepower Rated Devices)	–	–	50 Operations @ 600% of Full Load Motor Current (p.f. = .40 - .50)
Short Circuit Withstand	–	–	≥ 10 kA* (600V and ≤ .50 power factor)
Short Circuit Make	–	–	≥ 10 kA* (600V and ≤ .50 power factor)

<sup>1</sup> Testing alternates between mechanical & electrical operations. This reduces the severity of the electrical test by allowing additional cooling time during electrical testing.

+ All Meltric switch rated Decontactors are UL listed with short circuit ratings of at least 65kA achieved at 600VAC and ≤ .15 power factor.





# Benefit from Using Deconnectors...

## Ensure Worker Safety

Meltric Deconnectors help ensure safety by eliminating the hazards associated with pin & sleeve and twist-type devices.

- ▼ The integral switching function ensures that the plug contacts are dead prior to removal from the receptacle and the dead front construction prevents unintended access to live parts. This eliminates potential injury due to electrical shock.
- ▼ Spring-loaded, silver-nickel butt style contacts maintain proper contact force, withstand arcing, resist wear, and maintain low contact resistance. This ensures the integrity of the connection over thousands of operations and eliminates injuries caused by heat, oxidation, wear and arcing induced failures of brass contacts.
- ▼ Push button operation and spring-loaded plug and receptacle disengagement ensures quick and operator independent load breaking. This helps minimize harmful arcing during disconnection and enclosed arc chambers eliminate the possibility of external arcs.
- ▼ Horsepower, switch and short circuit ratings provide significant additional protection during locked-rotor or other significant overload situations. This eliminates injuries that could occur with standard plug and receptacles.



## Simplify Code Compliance

Deconnectors provide a simple and cost effective means of helping facilities to achieve compliance with the National Electric Code and NFPA 70E.

### NEC Compliance

Articles 430.101 through 430.113 of the National Electrical Code regulate motor disconnection means. They require motors to have readily accessible, 'line of sight' disconnects that are either an approved switch or a properly rated plug and receptacle.

- ▼ **430.102** *A disconnecting means must be located in sight from the motor and driven equipment.*
- ▼ **430.107** *The disconnecting means must be readily accessible.*
- ▼ **430.109** *The disconnecting means must be an approved switch or horsepower rated plug & receptacle.*

Meltric's DECONNECTOR Series plugs and receptacles are both horsepower and switch rated. Thus, they can function as a 'line of sight' disconnect in addition to providing a convenient plug and play power connection for the motor. The need for an auxiliary disconnect switch is eliminated.

### NFPA 70E

This OSHA consensus standard covers electrical safety related work practices and procedures for employees who work on or near exposed energized electrical conductors or other live circuit parts. Relevant requirements include:

**Power must be proven to be off before work can be performed. This requires:**

- ▼ The safe interruption of the load & opening of the disconnect
- ▼ Visual verification/voltage testing to ensure deenergization

**The potential electrical hazard must be identified and documented.**

- ▼ Flash hazard analysis must be performed
- ▼ Flash protection boundaries must be determined

**Appropriate steps must be taken to protect persons working near live parts or within the flash protection boundary.**

- ▼ PPE must be worn based on incident energy exposure levels (cal/cm<sup>2</sup>)
- ▼ Only properly qualified persons are allowed to perform work

# ... Throughout your Facility

Wiring and connection systems utilizing conventional switches and/or pin & sleeve devices would typically require all of the above listed protective measures to comply with NFPA 70E. By using Meltric's DECONTACTOR Series plugs and receptacles to connect equipment, users can very simply comply with these requirements.

Switch ratings ensure the safe interruption of the load and removing the plug from the receptacle provides visual verification that the power is off. Dead front construction prevents exposure to live parts and thus eliminates the need to perform hazard analysis, establish flash protection boundaries and use electrical personal protective equipment. Plug and play simplicity allows qualified mechanics to quickly change-out motors and equipment without the assistance of electrical personnel.

## Motor Change-Out Process Comparison

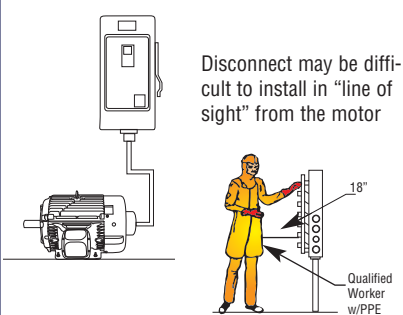
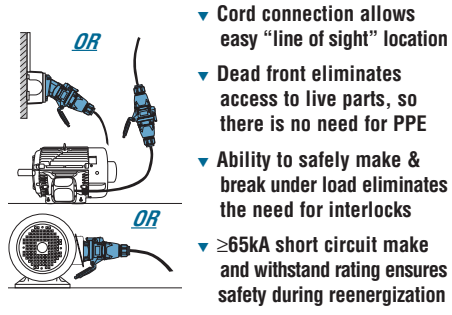
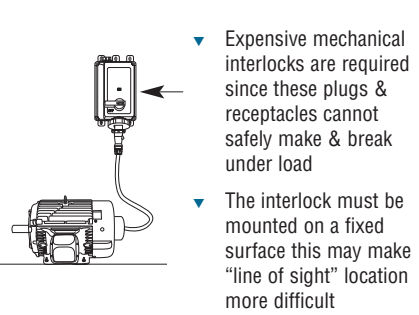
MOTOR HARD-WIRED TO A BLADED DISCONNECT SWITCH	MOTOR CONNECTED WITH A MELTRIC MOTOR PLUG	MOTOR CONNECTED WITH A COMPETITIVE PLUG & RECEPTACLE
 <p>Disconnect may be difficult to install in "line of sight" from the motor</p> <p>18"</p> <p>Qualified Worker w/PPE</p>	 <p>OR</p> <p>OR</p> <ul style="list-style-type: none"> <li>▼ Cord connection allows easy "line of sight" location</li> <li>▼ Dead front eliminates access to live parts, so there is no need for PPE</li> <li>▼ Ability to safely make &amp; break under load eliminates the need for interlocks</li> <li>▼ ≥65kA short circuit make and withstand rating ensures safety during reenergization</li> </ul>	 <ul style="list-style-type: none"> <li>▼ Expensive mechanical interlocks are required since these plugs &amp; receptacles cannot safely make &amp; break under load</li> <li>▼ The interlock must be mounted on a fixed surface this may make "line of sight" location more difficult</li> </ul>
MOTOR CHANGE-OUT PROCESS	MOTOR CHANGE-OUT PROCESS	MOTOR CHANGE-OUT PROCESS
<ol style="list-style-type: none"> <li>1. Electrician opens disconnect switch</li> <li>2. Determine PPE requirements and obtain</li> <li>3. Remove disconnect cover</li> <li>4. Voltmeter test to verify deenergization</li> <li>5. Apply lockout/tagout</li> <li>6. Disconnect motor from hard-wiring</li> <li>7. Mechanic removes old/installs new motor</li> <li>8. Electrician connects motor to hard wiring</li> </ol>	<ol style="list-style-type: none"> <li>1. Mechanic removes plug from receptacle</li> <li>2. Apply lockout/tagout as required</li> <li>3. Mechanic removes old/installs new motor</li> <li>4. Mechanic inserts plug into receptacle</li> </ol> <p><i>Meltric Makes it Safe &amp; Easy</i></p>	<ol style="list-style-type: none"> <li>1. Open interlock switch</li> <li>2. Determine PPE requirements &amp; obtain</li> <li>3. Remove interlock cover</li> <li>4. Voltmeter test to verify deenergization</li> <li>5. Remove plug</li> <li>6. Apply lockout/tagout as required</li> <li>7. Remove old/install new motor</li> <li>8. Insert plug into receptacle</li> </ol>

## Reduce Equipment & Installation Costs

Meltric's Decontactors help users reduce equipment and associated installation costs. Their switch ratings and ability to safely make and break under full load eliminates the need for the expensive interlocks that are required with pin and sleeve devices. Their ability to function as the NEC required 'line of sight' disconnect eliminates the need for auxiliary disconnect switches and their optional pilot contacts can eliminate the need for auxiliary connectors for control circuits. Installation costs are reduced because there is no longer a need to install these eliminated components and because the cord connection can eliminate the need for hard wiring.

## Reduce Equipment Change-out Downtime & Cost

Using Meltric's DECONTACTOR Series plug and receptacles to connect motors and other equipment instead of hard-wiring can help reduce equipment change-out time by as much as 50%. With new motors pre-wired with Decontactor plugs or inlets, the only electrical connection required during the change-out will be to plug in the new motor. Thus, a mechanic will be able to perform the change-out without the immediate aid of an electrician. This avoids the scheduling hassle of needing to also provide an electrician and eliminates the extra downtime required to do the wiring. The pre-wiring of replacement motors with Decontactor plugs or inlets can be done off-site and during the convenience of non-downtime periods. This makes Decontactor Series plugs and receptacles an ideal choice for 'plug and play' and modular process applications.

# Selecting the Right DECONTACTOR™ Family

**All Decontactors (DSN, DS and DB) feature:**

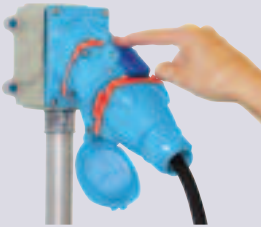

- ▼ UL & CSA switch ratings
- ▼ Short circuit closing and withstand protection (65kA to 100kA)

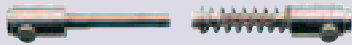

- ▼ Silver-Nickel contact material
- ▼ Spring-loaded, butt-style contacts

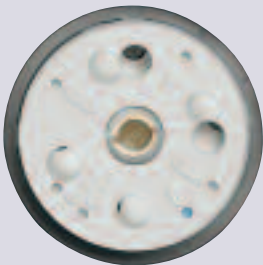

- ▼ Dead front safety shutter
- ▼ Optional auxiliary contacts



## DSN Series (pages 21-32)

**Choose DSN Series for its...**

- ▼ Compact, lightweight design
- ▼ Automatic NEMA 4X watertightness

**Common Applications**

- ▼ Wet or washdown environments
- ▼ Plug & play electrical connections



## DS Series (pages 33-50)

**Choose DS Series for its...**

- ▼ High amperage range (up to 200A)
- ▼ Poly or metal casing materials (60A and above)
- ▼ Larger conductor capacities

**Common Applications**

- ▼ Heavy industry
- ▼ High amperage equipment



## DB Series (pages 51-64)

**Choose DB Series for its...**

- ▼ High HP ratings (up to 60 hp)
- ▼ Robust, heavy duty construction

**Common Applications**

- ▼ Motors with frequent make and break requirements
- ▼ Harsh environments

Model	Casing Material	Maximum Voltage (VAC)	Amperage Rating	Maximum Number of Contacts		Environmental Rating	Maximum Horsepower Rating	
				Main	Auxiliary		480 VAC	600 VAC
DSN20	Poly	480 VAC	20A	3P+N+E	–	NEMA 4X IP66/67	5 hp	–
DSN30	Poly	600 VAC	30A	3P+N+E	2	NEMA 4X IP66/67	10 hp	15 hp
DSN60	Poly	600 VAC	60A	3P+N+E	4	NEMA 4X IP66/67	20 hp	20 hp

Model	Casing Material	Maximum Voltage (VAC)	Amperage Rating	Maximum Number of Contacts		Environmental Rating	Maximum Horsepower Rating	
				Main	Auxiliary		480 VAC	600 VAC
DS20	Poly	600 VAC	20A	3P+N+E	2	NEMA 3R	5 hp	7.5 hp
DS30	Poly	600 VAC	30A	3P+N+E	4	NEMA 3R	10 hp	10 hp
DS60	Poly or Metal	600 VAC	60A	3P+N+E	3	NEMA 3R	20 hp	25 hp
DS100C	Poly or Metal	600 VAC	100A	3P+N+E	3	NEMA 3R	20 hp	25 hp
DS100	Poly or Metal	600 VAC	100A	3P+N+E	5	NEMA 3R	–	–
DS200	Metal	480 VAC	200A	3P+N+E	5	NEMA 3R	–	–

Model	Casing Material	Maximum Voltage (VAC)	Amperage Rating	Maximum Number of Contacts		Environmental Rating	Maximum Horsepower Rating	
				Main	Auxiliary		480 VAC	600 VAC
DB30	Zinc Aluminum	600 VAC	30A	3P+N+E	2	IP67	10 hp	10 hp
DB60	Zinc Aluminum	600 VAC	60A	3P+N+E	2	IP67	30 hp	30 hp
DB100	Zinc Aluminum	600 VAC	100A	3P+N+E	4	IP67	60 hp	60 hp

# DSN

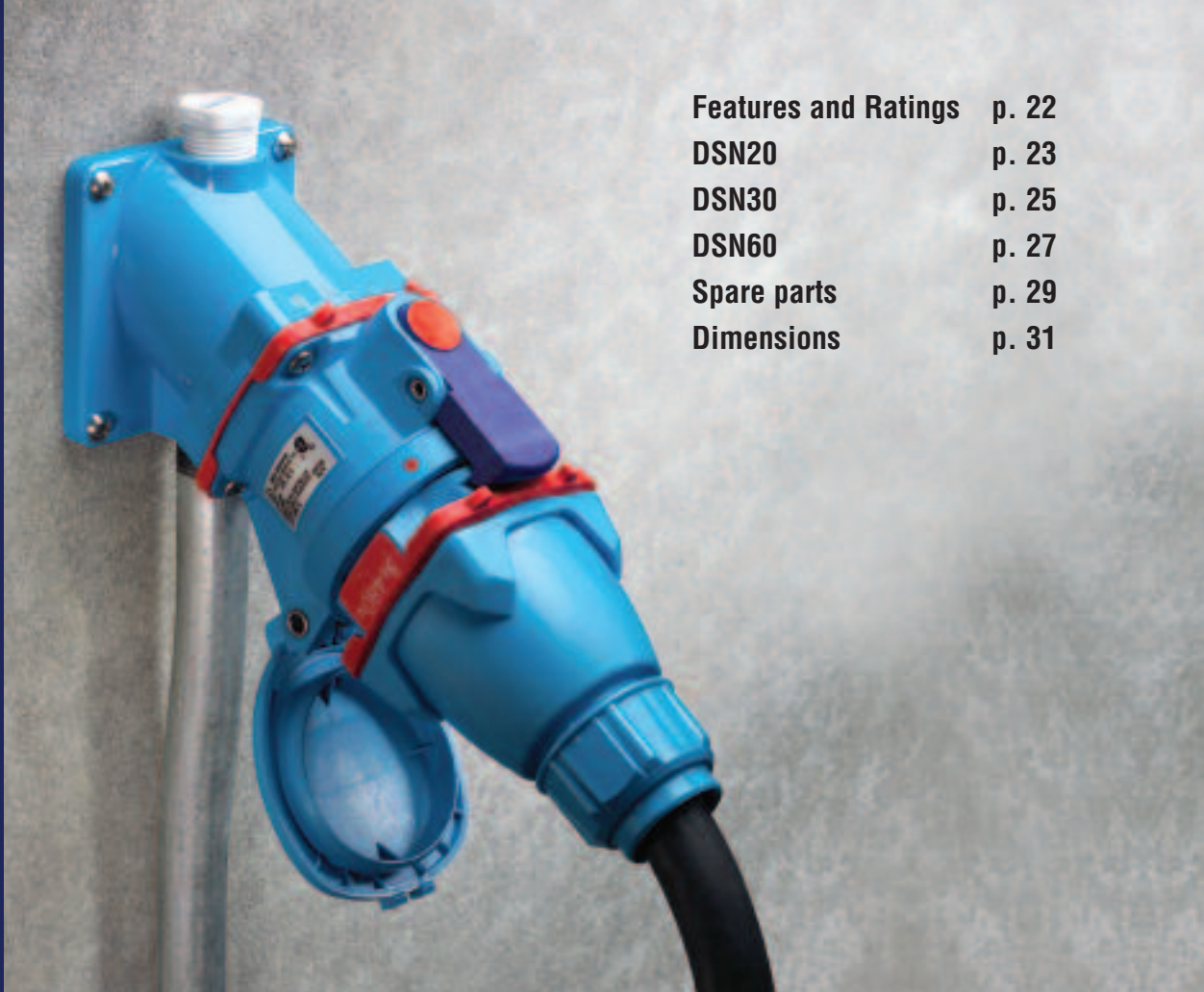

Features and Ratings	p. 22
DSN20	p. 23
DSN30	p. 25
DSN60	p. 27
Spare parts	p. 29
Dimensions	p. 31



## Switch rated plugs and receptacles with NEMA 4X protection

DSN Series products are switch and hp rated for quick, safe equipment changeouts. DSNs are ideal for wet environments since they offer NEMA 4X watertightness as soon as the plug is latched to the receptacle or as soon as the receptacle lid is closed.

### Main Advantages

- ▼ Switch & Hp rated (AC only)
- ▼ 100 kA short circuit rated\*
- ▼ NEMA 4X, IP66/67
- ▼ Compact, lightweight design
- ▼ Up to 4 auxiliary contacts

\* See note under General Ratings on the next page

### Highlighted Advantage

Simplify NFPA 70E Compliance

See pgs 17-18 for more information



# Product Features

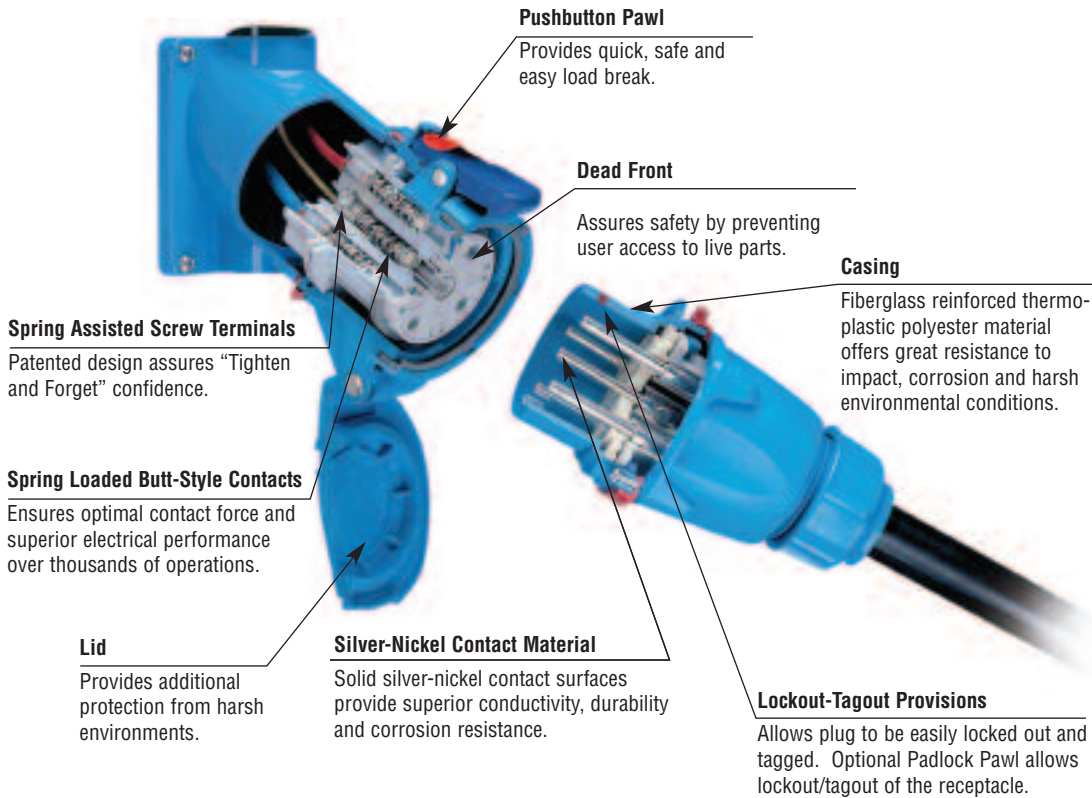

## General Ratings

<b>Amperage</b>	20 to 60A
<b>Voltage</b>	600 VAC*, 250 VDC Max
<b>Frequency</b>	50-400 Hz
<b>Horsepower</b>	1/2 to 20 hp
<b>Short-Circuit (Make &amp; Withstand)</b>	100kA**
<b>Environmental</b>	NEMA 4X, IP66 + 67
<b>Temperature</b>	min -40°F/max 140°F

\* DSN1 devices are 480 VAC

\*\* Testing was performed with RK1 current limiting fuses sized at 400% or more of the highest full load motor ampacity associated with the devices horsepower ratings.

## Listings

Category	UL	CSA	IEC
Plugs and Receptacles	UL 1682	C22.2 No. 182.1	60309-1
Branch Circuit Disconnect Switching (AC only)	UL Subject 2682 (Performance tested to UL 98)	UL Subject 2682	60947-3, AC22, AC23
Motor Circuit Disconnect Switching (AC only)	UL Subject 2682 (Performance tested to UL 508)	UL Subject 2682	

CE ratings available upon request

Courtesy of Gross Automation 1724 South Johnson Road New Berlin, WI PH: 262-446-0000 FAX: 262-446-0300 www.meltricsales.com

## Operating Instructions

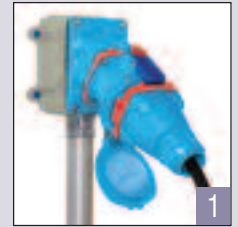

When the plug and receptacle are latched together, the circuit is connected.

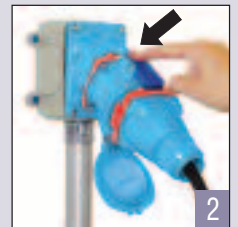

Pressing the pawl causes the DECONNECTOR to break the circuit. The plug is ejected to its rest position; its contacts are now dead.

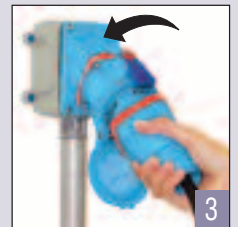

Rotating the 'dead' plug 30° counterclockwise closes the safety shutter and frees the plug to be withdrawn from the receptacle.

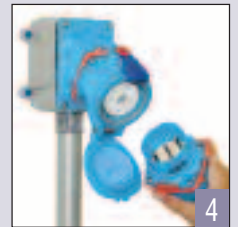

The plug and the receptacle are separated. The safety shutter prevents access to live parts.

5 To reconnect, insert plug into receptacle, rotate 30° clockwise, and apply insertion force.

## Highlighted Feature

### Typical Device Labels

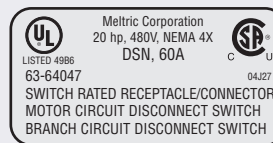

DSN Deconnectors are UL & CSA rated for "motor circuit" and "branch circuit" disconnect switching – up to 20 hp and up to 60A



# DECONTACTOR™ – 20A

## Switch Rated Plugs & Receptacles

### Ratings

- Voltage**  
480 VAC
- Switch Rating (AC Only)**  
Branch Circuit & Motor Circuit Disconnect Switching
- Horsepower Ratings**
  - 120V 1Ø 1/2 hp
  - 240V 1Ø 1 hp
  - 208V 3Ø 2 hp
  - 240V 3Ø 2 hp
  - 480V 3Ø 5 hp
- Short Circuit Rating**  
100kA Close & Withstand  
Testing was performed with RK1 current limiting fuses sized at 400% of the highest full load motor ampacity associated with the devices hp rating.
- Environmental Ratings**  
NEMA 4X, IP66 + 67
- Temperature Range**  
Min -40°F/Max 140°F  
See pg 194 for temps below -15°F.
- Wiring Capacity**  
Min 20 AWG Max 12 AWG
- Listings**  
UL, CSA, IEC, CE\*  
\* Contact Customer Service

### Receptacle (female)



 Don't forget to add installation accessories to your order

### Inlet (male)





Voltage	Polarity	Part # Poly
120/208V	3P+N+E	63-14167
125V	1P+N+E	63-14075
125/250V	2P+N+E	63-14076
208V	2P+E	63-14162
208V	3P+E	63-14163
250V	2P+E	63-14072
250V	3P+E	63-14073
277V	1P+N+E	63-14045
277/480V	3P+N+E	63-14047
347/600V	3P+N+E	-
480V	2P+E	63-14042
480V	3P+E	63-14043
600V	2P+E	-
600V	3P+E	-

Voltage	Polarity	Part # Poly
120/208V	3P+N+E	63-18167
125V	1P+N+E	63-18075
125/250V	2P+N+E	63-18076
208V	2P+E	63-18162
208V	3P+E	63-18163
250V	2P+E	63-18072
250V	3P+E	63-18073
277V	1P+N+E	63-18045
277/480V	3P+N+E	63-18047
347/600V	3P+N+E	-
480V	2P+E	63-18042
480V	3P+E	63-18043
600V	2P+E	-
600V	3P+E	-

Other voltage configurations are available – contact customer service at 800.433.7642.

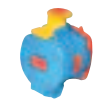
### Main Options

-  **Emergency Stop Pawl**
-  **Padlock Pawl**
-  **Self-Ejecting Devices\***  
\* Requires straight insertion receptacle or inlet and self-ejecting plug or connector

### Receptacle Options

Receptacle Options	Suffix #
Straight Insertion	Recept # - A188
Self-Ejecting Connector Release	Recept # - 345-A188
Emergency Stop Pawl	Recept # - 375
Padlock Pawl	Recept # - 843
Closed Lid Configuration	Recept # - NC

### Inlet Options

Inlet Options	Suffix #
Self-Ejecting Plug Release	Inlet # - 338-A188
Straight Insertion	Inlet # - A188
With No Lockout Hole	Inlet # - A155

See pgs 171-180 for detailed information on these options

**DSN20 Order Example:**  
To order a receptacle with a padlock pawl add **-843** the receptacle part number.  
DSN20 receptacle 3P+E= 63-14043-**843**  
Appropriate accessory numbers must also be included on the order

# Installation Accessories

## Handles



NPT	Poly Handle	Cable Range	Extended Handle	Nylon Handle	Angled Handle
1/2"	61-1A013-12	.20 - .83	61-1A413	-	-
3/4"	61-1A013-34	.31 - .59	-	61-1A013	-
1"	61-1A013-1	.32 - .67	-	-	61-1A313

**Notes:**

- Finger draw plates are recommended for easier connector closure on cord to cord assemblies.
- For available cord grips, see pgs 167-168.

For a guideline of NPT sizes based on cable ranges, see DSN3 on pg 26.

## Angles



Nylon 30° Angle	Metal 30° Angle	Metal Straight Adapter - Inlet	Metal Straight Adapter - Receptacle
61-1A027	MA1	MSPN	MS1

## Junction Boxes



NPT	Metal Box	Metal Box with Nylon Angle	Poly* Conduit Entry
1/2"	MB312-601	61-1A053-080-12	61-1A023-12
3/4"	MB334-601	61-1A053-080-34	61-1A023-34
1"	MB31-601	61-1A053-080-1	-
1 1/4"	MB3114-601	61-1A053-080-114	-

\* For poly devices only

## Miscellaneous Accessories



\* Set of Two (2)

For Male Devices Only

For Male Devices Only

Finger Drawplates	Protective Cap	Padlockable Plug Cap
61-1A346	61-1A126	61-1A826

\* Recommended for cord to cord assembly applications, for easier connector closure

## Specialty Products Spotlight

### Voltage Phase Rotation Meter



Voltage phase rotation meter assemblies offer an easy means of testing Meltric receptacles for voltage and motor rotation. See pg 169.

## Order Example

A typical order should include an inlet part number, a receptacle part number **AND** the matching handles, angles or other required accessories.

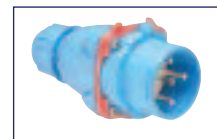

Male Inlet with Handle (Plug)  
63-18043 + 61-1A013



Female Receptacle with Angle Adapter  
63-14043 + 61-1A027





# DECONTACTOR™ – 30A

## Switch Rated Plugs & Receptacles

### Ratings

- Voltage**  
600 VAC, 250 VDC
- Switch Ratings (AC Only)**  
Branch Circuit & Motor Circuit Disconnect Switching
- Horsepower ratings**
  - 120V 1Ø 1 hp
  - 240V 1Ø 3 hp
  - 208V 3Ø 5 hp
  - 240V 3Ø 5 hp
  - 480V 3Ø 10 hp
  - 600V 3Ø 15 hp
- Short Circuit Rating**  
100kA Close & Withstand  
Testing was performed with RK1 current limiting fuses sized at 400% of the highest full load motor ampacity associated with the devices hp rating.
- Environmental Ratings**  
NEMA 4X, IP66 + 67
- Temperature Range**  
Min -40°F/Max 140°F  
See pg 194 for temps below -15°F.
- Wiring Capacity**  
Min 14 AWG Max 8 AWG  
Aux Contacts - Max 8 AWG
- Listings**  
UL, CSA, IEC, CE\*  
\* Contact Customer Service

### Receptacle (female)



Don't forget to add installation accessories to your order

### Inlet (male)



Voltage	Polarity	Part # Poly
120/208V	3P+N+E	63-34167
125V	1P+N+E	63-34075
125/250V	2P+N+E	63-34076
208V	2P+E	63-34162
208V	3P+E	63-34163
250V	2P+E	63-34072
250V	3P+E	63-34073
277V	1P+N+E	63-34045
277/480V	3P+N+E	63-34047
347/600V	3P+N+E	63-34147
480V	2P+E	63-34042
480V	3P+E	63-34043
600V	2P+E	63-34142
600V	3P+E	63-34143

Voltage	Polarity	Part # Poly
120/208V	3P+N+E	63-38167
125V	1P+N+E	63-38075
125/250V	2P+N+E	63-38076
208V	2P+E	63-38162
208V	3P+E	63-38163
250V	2P+E	63-38072
250V	3P+E	63-38073
277V	1P+N+E	63-38045
277/480V	3P+N+E	63-38047
347/600V	3P+N+E	63-38147
480V	2P+E	63-38042
480V	3P+E	63-38043
600V	2P+E	63-38142
600V	3P+E	63-38143

Other voltage configurations are available – contact customer service at 800.433.7642.

### Main Options



Auxiliary/Pilot Contacts



Emergency Stop Pawl



Padlock Pawl



Self-Ejecting Devices\*

\* Requires straight insertion receptacle or inlet and self-ejecting plug or connector

See pgs 171-180 for detailed information on these options

### Receptacle Options

### Suffix #

With 2 Auxiliary/Pilot Contacts	Recept # - 972
Straight Insertion	Recept # - A188
Self-Ejecting Connector Release	Recept # - 345-A188
Emergency Stop Pawl	Recept # - 375
Padlock Pawl	Recept # - 843
Closed Lid Configuration	Recept # - NC
With Auxiliary Switch	Recept # - 270

### Inlet Options

### Suffix #

With 2 Auxiliary/Pilot Contacts	Inlet # - 972
Self-Ejecting Plug Release	Inlet # - 338-A188
Straight Insertion	Inlet # - A188
With No Lockout Hole	Inlet # - A155
For Auxiliary Switch	Inlet # - NNF

#### DSN30 Order Example:

To order 2 auxiliary contacts on an inlet and receptacle add -972 to the part numbers.

DSN30 Inlet 3P+E = 63-38043-972

DSN30 Receptacle 3P+E = 63-34043-972

Appropriate accessory part numbers must also be included on the order.

# Installation Accessories

## Handles



NPT	Poly Handle	Cable Range	Poly Handle w/Clamp & Bushing	Nylon Handle
1/2"	61-3A013-12	.20 - .83	–	61-3A013
3/4"	61-3A013-34	.750 - .875	1PM514	–
1"	61-3A013-1	.875 - 1.000	1PM516	–
1 1/4"	61-3A013-114	1.000 - 1.125	1PM518	–
		1.125 - 1.250	1PM520	–
		1.250 - 1.375	1PM522	–

**Notes:** • Finger draw plates are recommended for easier connector closure on cord to cord assemblies.  
• For available cord grips, see pgs 167-168.

## Angles



Nylon 30° Angle	Metal 30° Angle	Metal Angle FS/FD Box 30°	Metal Straight Adapter
61-3A027	MA2	MAFS2	MS2

## Junction Boxes



NPT	Metal Box	Metal Box with Nylon Angle	Poly* Conduit Entry
1/2"	MB312	61-3A053-080-12	61-3A023-12
3/4"	MB334	61-3A053-080-34	61-3A023-34
1"	MB31	61-3A053-080-1	–
1 1/4"	MB3114	61-3A053-080-114	–

\* For poly devices only

## Miscellaneous Accessories



\* Set of Two (2)

For Male Devices Only

For Male Devices Only

Finger Drawplates	Protective Cap	Padlockable Plug Cap
61-3A346	61-3A126	61-3A826

\* Recommended for cord to cord assembly applications, for easier connector closure

## NPT Guidelines

Cable Range	NPT
.062 - .5	1/2"
.187 - .75	3/4"
.437 - 1.10	1"
.750 - 1.375	1 1/4"

NPT sizes are determined by the cable diameter and third party cord grip.

## Order Example

A typical order should include an inlet part number, a receptacle part number **AND** the matching handles, angles or other required accessories.

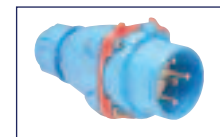

Male Inlet with Handle (Plug)  
63-38043 + 61-3A013



Female Receptacle with Angle Adapter  
63-34043 + 61-3A027



# DECONTACTOR™ – 60A

## Switch Rated Plugs & Receptacles

### Ratings

- Voltage**  
600 VAC, 250 VDC
- Switch Ratings (AC Only)**  
Branch Circuit & Motor Circuit Disconnect Switching
- Horsepower ratings**
  - 120V 1Ø 2 hp
  - 240V 1Ø 3 hp
  - 208V 3Ø 7 1/2 hp
  - 240V 3Ø 7 1/2 hp
  - 480V 3Ø 20 hp
  - 600V 3Ø 20 hp
- Short Circuit Rating**  
100kA Close & Withstand  
Testing was performed with RK1 current limiting fuses sized at 400% of the highest full load motor ampacity associated with the devices hp rating.
- Environmental Ratings**  
NEMA 4X, IP66 + 67
- Temperature Range**  
Min -40°F/Max 140°F  
See pg 194 for temps below -15°F.
- Wiring Capacity**  
Min 12 AWG Max 4 AWG  
Aux Contacts - Max 12 AWG
- Listings**  
UL, CSA, IEC, CE\*  
\* Contact Customer Service

### Receptacle (female)



Don't forget to add installation accessories to your order

### Inlet (male)



Voltage	Polarity	Part # Poly
120/208V	3P+N+E	63-64167
125V	1P+N+E	63-64075
125/250V	2P+N+E	63-64076
208V	2P+E	63-64162
208V	3P+E	63-64163
250V	2P+E	63-64072
250V	3P+E	63-64073
277V	1P+N+E	63-64045
277/480V	3P+N+E	63-64047
347/600V	3P+N+E	63-64147
480V	2P+E	63-64042
480V	3P+E	63-64043
600V	2P+E	63-64142
600V	3P+E	63-64143

Voltage	Polarity	Part # Poly
120/208V	3P+N+E	63-68167
125V	1P+N+E	63-68075
125/250V	2P+N+E	63-68076
208V	2P+E	63-68162
208V	3P+E	63-68163
250V	2P+E	63-68072
250V	3P+E	63-68073
277V	1P+N+E	63-68045
277/480V	3P+N+E	63-68047
347/600V	3P+N+E	63-68147
480V	2P+E	63-68042
480V	3P+E	63-68043
600V	2P+E	63-68142
600V	3P+E	63-68143

Other voltage configurations are available – contact customer service at 800.433.7642.

### Main Options



Auxiliary/Pilot Contacts



Emergency Stop Pawl



Padlock Pawl



Self-Ejecting Devices\*

\* Requires straight insertion receptacle or inlet and self-ejecting plug or connector

See pgs 171-180 for detailed information on these options

### Receptacle Options

### Suffix #

With 2 Auxiliary/Pilot Contacts	Recept # - 972
With 3 Auxiliary/Pilot Contacts	Recept # - 973
With 4 Auxiliary/Pilot Contacts	Recept # - 974
Straight Insertion	Recept # - A188
Self-Ejecting Connector Release	Recept # - 345-A188
Emergency Stop Pawl	Recept # - 375
Padlock Pawl	Recept # - 843
Closed Lid Configuration	Recept # - NC
With Auxiliary Switch	Recept # - 270

### Inlet Options

### Suffix #

With 2 Auxiliary/Pilot Contacts	Inlet # - 972
With 3 Auxiliary/Pilot Contacts	Inlet # - 973
With 4 Auxiliary/Pilot Contacts	Inlet # - 974
Self-Ejecting Plug Release	Inlet # - 338-A188
Straight Insertion	Inlet # - A188
With No Lockout Hole	Inlet # - A155
For Auxiliary Switch	Inlet # - NNF

#### DSN60 Order Example:

To order 2 auxiliary contacts on an inlet and receptacle add -972 to the part numbers.

DSN60 Inlet 3P+E = 63-68043-972

DSN60 Receptacle 3P+E = 63-64043-972

Appropriate accessory part numbers must also be included on the order.

# Installation Accessories

## Handles



Makes connector closures easier

NPT	Poly Handle	Cable Range	Poly Handle w/Clamp & Bushing	Nylon Handle	Poly Handle w/built in Draw Grips
1/2"	61-6A013-12	.32 - 1.25	–	–	61-6A473
3/4"	61-6A013-34	.39 - 1.18	–	61-6A013	–
1"	61-6A013-1	.750 - .875	3PM514	–	–
1 1/4"	61-6A013-114	.875 - 1.000	3PM516	–	–
		1.000 - 1.125	3PM518	–	–
		1.125 - 1.250	3PM520	–	–
		1.250 - 1.375	3PM522	–	–

**Notes:** • Finger draw plates are recommended for easier connector closure on cord to cord assemblies.  
• For available cord grips, see pgs 167-168.

• For a guideline of NPT sizes based on cable ranges, see DSN3 on pg 26.

## Angles



Nylon 30° Angle	Metal 30° Angle	Metal 70° Angle	Metal Angle FS/FD Box 30°	Metal Straight Adapter
61-6A027	MA3	89-3A027	MAFS3	MS3

## Junction Boxes



NPT	Metal Box	Metal Box with Nylon Angle	Poly* Conduit Entry
1/2"	MB312	61-6A053-080-12	61-6A023-12
3/4"	MB334	61-6A053-080-34	61-6A023-34
1"	MB31	61-6A053-080-1	61-6A023-1
1 1/4"	MB3114	61-6A053-080-114	–

\* For poly devices only

## Miscellaneous Accessories



Set of Two (2)



For Male Devices Only



For Male Devices Only



Finger Drawplates	Protective Cap	Padlockable Plug Cap	Cord Grip w/Mesh
61-6A346	61-6A126	61-6A826	see pgs 167-168

## Accessory Spotlight

### Finger Drawplates



Finger drawplates are recommended for easier connector closure on cord to cord assemblies.

## Order Example

A typical order should include an inlet part number, a receptacle part number **AND** the matching handles, angles or other required accessories.

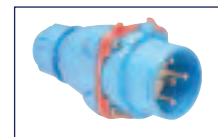

Male Inlet with Handle (Plug)  
63-68043 + 61-6A013







Female Receptacle with Angle Adapter  
63-64043 + 61-6A027

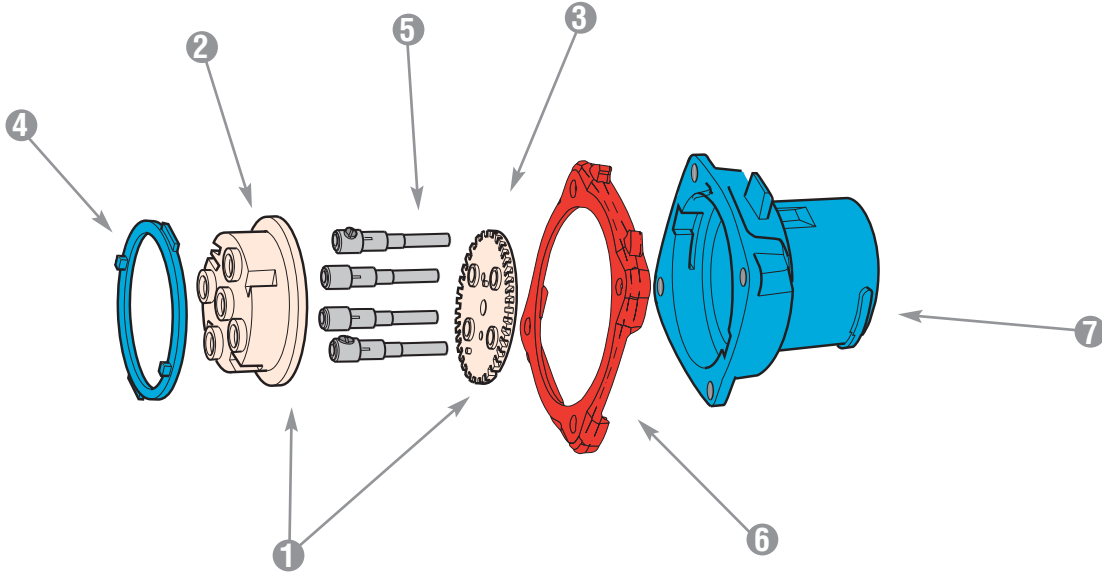

# Spare Parts Male Configuration







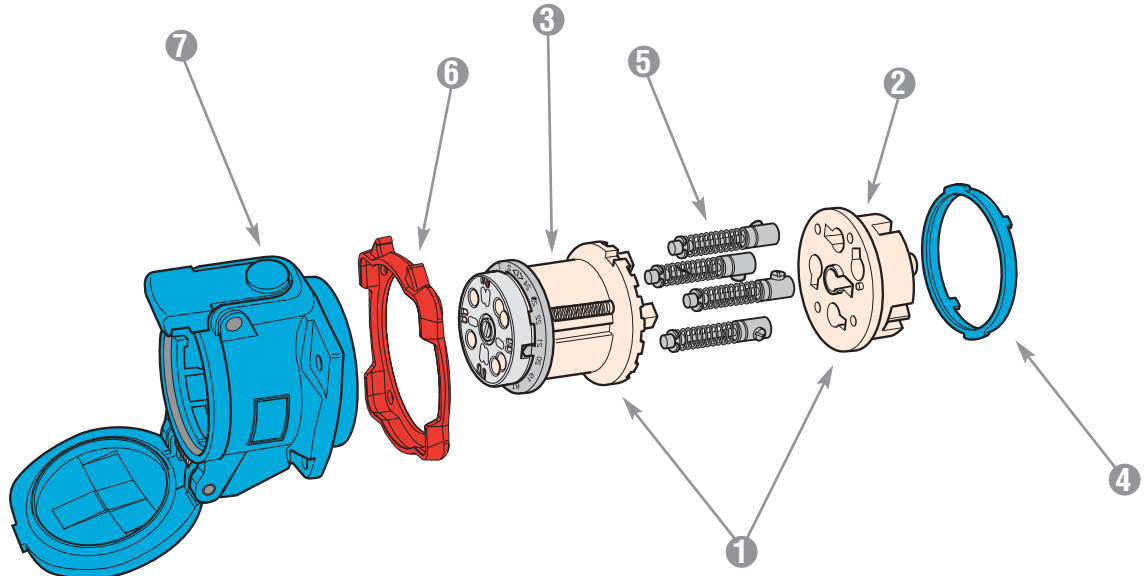

	DSN20 POLY	DSN30 POLY	DSN60 POLY
1 = Plug Interior	61-1A010*	61-3A010*	61-6A010*
2 = Interior Bottom	61-1A010-B	61-3A010-B	61-6A010-B
3 = Interior Top	61-1A010-T*	61-3A010-T*	61-6A010-T*
4 = Polyester Locking Ring	61-1A583	61-3A583	61-6A583
5 = Plug Contact	61-1A011	61-3A011	61-6A011
6 = Color-Coded Voltage Gasket	 61-1AB26	61-3AB26	61-6AB26
	 61-1AC26	61-3AC26	61-6AC26
	 61-1AR26	61-3AR26	61-6AR26
	 -	61-3AN26	61-6AN26
	 61-1AC26	61-3AC26	61-6AC26
7 = Plug Polyester Casing	61-1A014**	61-3A014**	61-6A014**

\* Voltage and phasing positions must be specified (5th, 6th & 7th digit of Part #) to duplicate your shutter and alignment notches.

\*\* For appropriate labeling on a device, please specify voltage, phasing, and product type

# Spare Parts Female Configuration



	DSN20 POLY	DSN30 POLY	DSN60 POLY
1 = Receptacle Interior	61-1A020*	61-3A020*	61-6A020*
2 = Interior Bottom	61-1A020-B	61-3A020-B	61-6A020-B
3 = Interior Top	61-1A020-T*	61-3A020-T*	61-6A020-T*
4 = Polyester Locking Ring	61-1A583	61-3A583	61-6A583
5 = Receptacle Contact	61-1A021	61-3A021	61-6A021
6 = Color-Coded Voltage Gasket	 61-1AB26	61-3AB26	61-6AB26
	 61-1AC26	61-3AC26	61-6AC26
	 61-1AR26	61-3AR26	61-6AR26
	 -	61-3AN26	61-6AN26
	 61-1AC26	61-3AC26	61-6AC26
7 = Receptacle Polyester Casing	61-1A024**	61-3A024**	61-6A024**

\* Voltage and phasing positions must be specified (5th, 6th & 7th digit of Part #) to duplicate your shutter and alignment notches.

\*\* For appropriate labeling on a device, please specify voltage, phasing, and product type



# Dimensions

## Inlet – Provided in inches and millimeters

Dimensions are for reference only

### Plug

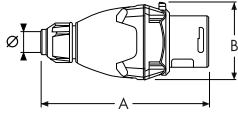

PRODUCT	A	B	Ø
	4.92	2.28	.27-.75
DSN20	125	58	7-19
	5.71	2.68	.32-.90
DSN30/DSN24	145	68	8-23
	5.98	3.27	.32-1.25
DSN60/DSN37	152	83	8-32

### Inlet with connector on/off

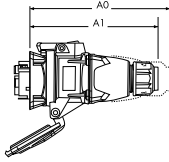

PRODUCT	A1	A0
	6.14	6.65
DSN20	156	169
	6.65	7.32
DSN30/DSN24	169	186
	6.89	8.03
DSN60/DSN37	175	204

### Inlet

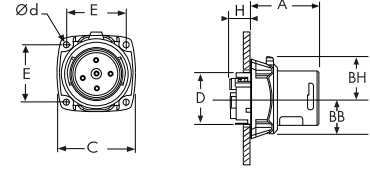

PRODUCT	A	BB	BH	C	D	E	H	Ød
	1.97	0.94	1.06	2.24	1.46	1.65	0.53	0.17
DSN20	50	24	27	57	37	42	13.5	4.2
	1.97	1.26	1.42	2.64	2.28	1.89	0.51	0.18
DSN30/DSN24	50	32	36	67	58	48	13	4.5
	2.13	1.54	1.73	3.07	2.68	2.17	0.59	0.19
DSN60/DSN37	54	39	44	78	68	55.2	15	4.8

### 30° inclined inlet/angle with connector on/off

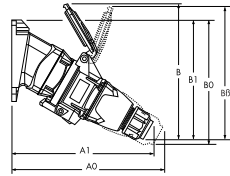

PRODUCT	A1	A0	B	B1	B0	BB
	7.28	7.72	6.38	5.94	6.18	
DSN20	185	196	162	151	157	
	7.68	8.27	8.23	6.73	7.09	
DSN30/DSN24	195	210	209	171	180	
	8.03	9.06	9.25	7.01	7.60	8.39
DSN60/DSN37	204	230	235	178	193	213

### 30° inlet/conduit box

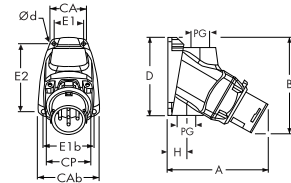

PRODUCT	A	B	CA	CAB	CP	D	E1	E1b	E2	H	PG	Ød
	4.53	4.45	1.77	2.68	2.24	3.54	1.42	2.20	3.07	1.48	0.50	0.18
DSN20	115	113	45	68	57	90	36	56	78	37.5		4.5
	4.41	4.13	3.31	3.31	2.64	4.21	2.76	2.76	2.76	0.69	0.50	0.24
DSN30/DSN24	112	105	84	84	67	107	70	70	70	17.5		6
	5.20	5.04	3.50	3.50	3.07	4.80	3.03	3.03	3.46	0.94	0.75	0.26
DSN60/DSN37	132	128	89	89	78	122	77	77	88	24		6.5

### 30° inclined inlet/angle/junction box with connector on/off

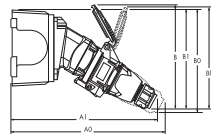

PRODUCT	A1	A0	B	B1	B0	BB
	9.88	10.31	6.38	6.06	6.30	
DSN20	251	262	162	154	160	
	10.16	10.75	8.23	6.85	7.20	
DSN30/DSN24	258	273	209	174	183	
	10.51	11.54	9.25	7.13	7.72	8.39
DSN60/DSN37	267	293	235	181	196	213

### 30° inlet/angle

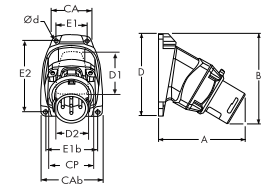

PRODUCT	A	B	CA	CAB	CP	D	D1	D2	E1	E1b	E2	Ød
	3.78	4.02	1.77	2.68	2.24	3.54	2.95	1.97	1.42	2.20	3.07	0.18
DSN20	96	102	45	68	57	90	75	50	36	56	78	4.5
	3.66	4.49	2.99	2.99	2.64	4.21	2.56	3.74	2.48	2.48	3.74	0.22
DSN30/DSN24	93	114	76	76	67	107	65	95	63	63	95	5.5
	4.06	4.80	2.99	2.99	3.07	4.21	2.56	3.74	2.48	2.48	3.74	0.22
DSN60/DSN37	103	122	76	76	78	107	65	95	63	63	95	5.5

### 30° inclined inlet/conduit box with connector on/off

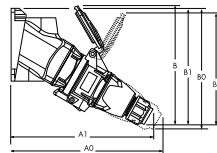

PRODUCT	A1	A0	B	B1	B0	BB
	8.03	8.46	6.38	6.38	6.61	
DSN20	204	215	162	162	168	
	8.43	9.02	8.23	6.38	6.73	
DSN30/DSN24	214	229	209	162	171	
	9.17	10.20	9.25	7.24	7.83	8.39
DSN60/DSN37	233	259	235	184	199	213

### inlet/angle/metal junction box

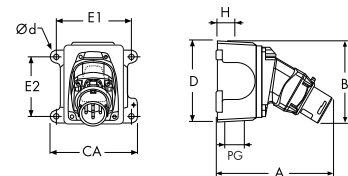

PRODUCT	A	B	CA	D	E1	E2	H	PG	Ød
	6.38	4.13	4.40	4.57	3.75	2.78	1.18	1.00	0.25
DSN20	162	105	111.8	116	95.3	70.6	30		6.4
	6.14	4.61	4.40	4.57	3.75	2.78	1.18	1.00	0.25
DSN30/DSN24	156	117	111.8	116	95.3	70.6	30		6.4
	6.54	4.92	4.40	4.57	3.75	2.78	1.18	1.00	0.25
DSN60/DSN37	166	125	111.8	116	95.3	70.6	30		6.4

# Dimensions

## Receptacle – Provided in inches and millimeters

Dimensions are for reference only

### connector

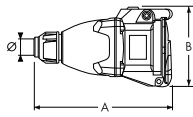

PRODUCT	A	B	Ø
DSN20	5.16	3.07	.27-.75
	131	78	7-19
DSN30/DSN24	6.38	4.06	.32-.90
	162	103	8-23
DSN60/DSN37	6.89	4.53	.32-1.25
	175	115	8-32

### receptacle with plug on/off

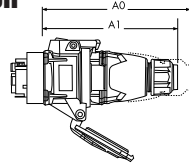

PRODUCT	A1	A0
DSN20	6.14	6.65
	156	169
DSN30/DSN24	6.65	7.32
	169	186
DSN60/DSN37	6.89	8.03
	175	204

### receptacle

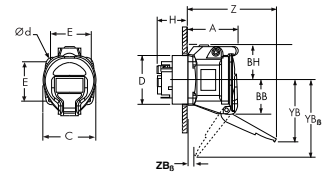

PRODUCT	A	BB	BH	C	D	E	H	YB	YBb	Z	Zb	Ød
DSN20	2.07	1.57	1.50	2.24	1.99	1.65	0.98	2.76		3.84		0.17
	52.7	40	38	57	50.5	42	25	70		97.5		4.2
DSN30/DSN24	2.61	2.09	1.97	2.87	2.28	1.89	0.59	3.86		4.47		0.18
	66.2	53	50	73	58	48	15	98		113.6		4.5
DSN60/DSN37	3.12	2.30	2.20	3.23	2.68	2.17	0.71	4.65	5.83	4.76	0.96	0.19
	79.2	58.5	56	82	68	55.2	18	118	148	121	24.4	4.8

### 30° inclined receptacle/angle with plug on/off

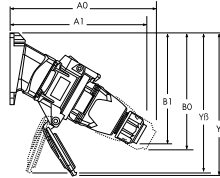

PRODUCT	A1	A0	B1	B0	Y	YB
DSN20	7.28	7.72	5.94	6.18	6.65	
	185	196	151	157	169	
DSN30/DSN24	7.68	8.27	6.73	7.09	8.23	
	195	210	171	180	209	
DSN60/DSN37	8.03	9.06	7.01	7.60	9.06	8.15
	204	230	178	193	230	207

### 30° receptacle/angle

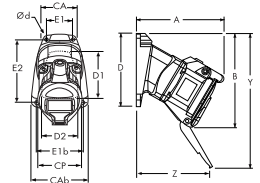

PRODUCT	A	B	CA	CAb	CP	D	D1	D2	E1	E1b	E2	Y	Z	Ød
DSN20	4.25	4.72	1.77	2.68	2.24	3.54	2.95	1.97	1.42	2.20	3.07	6.65	3.62	0.18
	108	120	45	68	57	90	75	50	36	56	78	169	92	4.5
DSN30/DSN24	4.69	5.55	2.99	2.99	2.87	4.21	2.56	3.74	2.48	2.48	3.74	8.23	3.39	0.22
	119	141	76	76	73	107	65	95	63	63	95	209	86	5.5
DSN60/DSN37	5.35	6.14	2.99	2.99	3.23	4.21	2.56	3.74	2.48	2.48	3.74	9.06	3.35	0.22
	136	156	76	76	82	107	65	95	63	63	95	230	85	5.5

### 30° inclined receptacle/conduit box with plug on/off

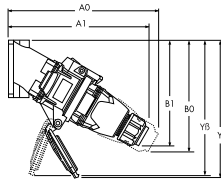

PRODUCT	A1	A0	B1	B0	Y	YB
DSN20	8.03	8.46	6.38	6.61	7.09	
	204	215	162	168	180	
DSN30/DSN24	8.43	9.02	6.38	6.73	7.87	
	214	229	162	171	200	
DSN60/DSN37	9.17	10.20	7.24	7.83	9.29	8.39
	233	259	184	199	236	213

### 30° receptacle/conduit box

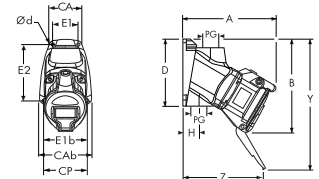

PRODUCT	A	B	CA	CAb	CP	D	E1	E1b	E2	H	PG	Y	Z	Ød
DSN20	5.00	5.16	1.77	2.68	2.24	3.54	1.42	2.20	3.07	1.48	0.50	7.09	4.37	0.18
	127	131	45	68	57	90	36	56	78	37.5		180	111	4.5
DSN30/DSN24	5.43	5.20	3.31	3.31	2.87	4.21	2.76	2.76	2.76	0.69	0.50	7.87	4.13	0.24
	138	132	84	84	73	107	70	70	70	17.5		200	105	6
DSN60/DSN37	6.50	6.38	3.50	3.50	3.23	4.80	3.03	3.03	3.46	0.94	0.75	9.29	4.49	0.26
	165	162	89	89	82	122	77	77	88	24		236	114	6.5

### 30° inclined receptacle/angle/ junction box with plug on/off

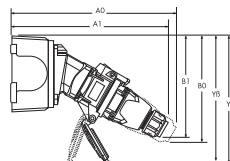

PRODUCT	A1	A0	B1	B0	Y	YB
DSN20	9.88	10.31	6.06	6.30	6.77	
	251	262	154	160	172	
DSN30/DSN24	10.16	10.75	6.85	7.20	8.35	
	258	273	174	183	212	
DSN60/DSN37	10.51	11.54	7.13	7.72	9.17	8.27
	267	293	181	196	233	210

### receptacle/angle/ metal junction box

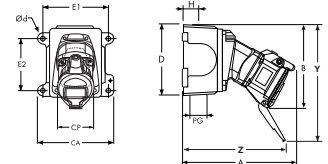

PRODUCT	A	B	CA	CP	D	E1	E2	H	PG	Y	Z	Ød
DSN20	6.85	4.84	4.40	2.24	4.57	3.75	2.78	1.18	1.00	6.77	6.22	0.25
	174	123	111.8	57	116	95.3	70.6	30		172	158	6.4
DSN30/DSN24	7.17	5.67	4.40	2.87	4.57	3.75	2.78	1.18	1.00	8.35	5.87	0.25
	182	144	111.8	73	116	95.3	70.6	30		212	149	6.4
DSN60/DSN37	7.83	6.26	4.40	3.23	4.57	3.75	2.78	1.18	1.00	9.17	5.83	0.25
	199	159	111.8	82	116	95.3	70.6	30		233	148	6.4



# DS



Features and Ratings	p. 34
DS20	p. 35
DS30	p. 37
DS60	p. 39
DS100C	p. 41
DS100	p. 43
DS200	p. 45
Spare parts	p. 47
Dimensions	p. 49



## Switch rated plugs and receptacles

DS Series Deconnectors provide a useful combination of capacity and ruggedness. DS are often used to connect motors and welders in the metals, quarry, automotive, and mining industries. They are designed for applications requiring large wiring capacities. The DS's NEMA 3R rating is achieved as soon as the plug and receptacle are fully engaged, making them an excellent choice for outdoor applications where rainproof performance is required.

### Main Advantages

- ▼ Switch & Hp rated (AC only)
- ▼ 65 kA to 100kA short circuit rated\*
- ▼ Up to 5 auxiliary contacts
- ▼ Amperage ratings up to 200A
- ▼ Metal or Poly construction

### Highlighted Advantage

Simplify NFPA 70E Compliance

See pgs 17-18 for more information



\* See note under General Ratings on the next page

# Product Features

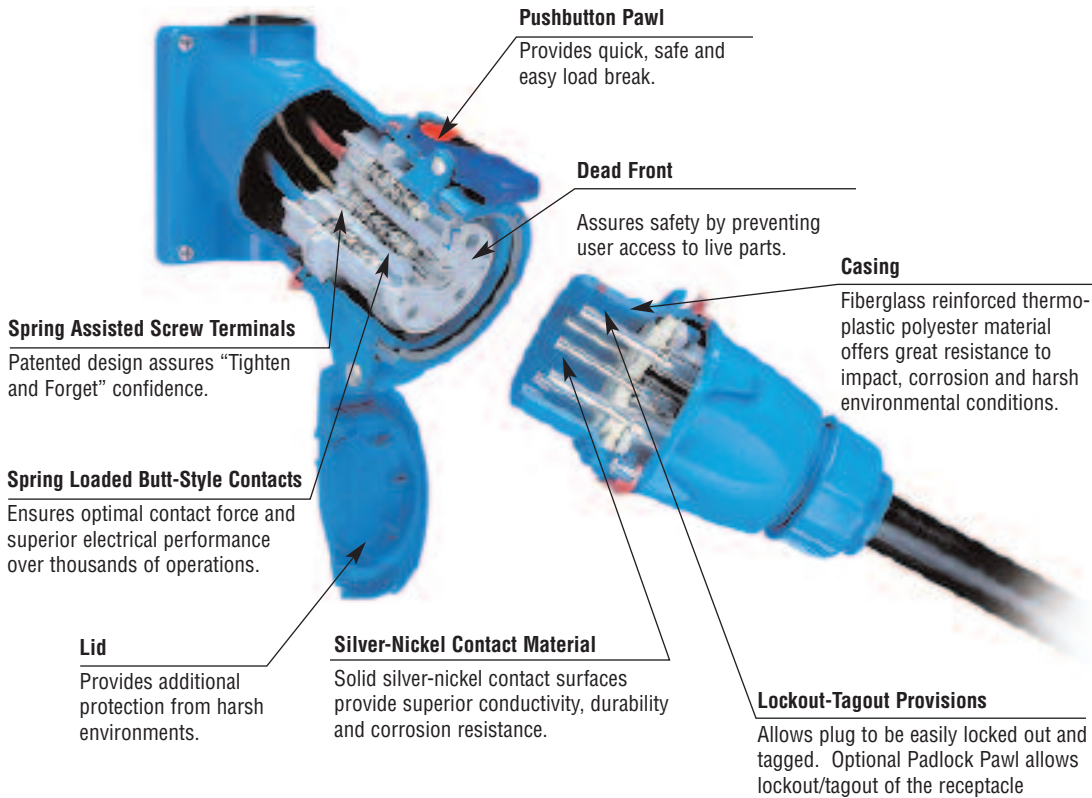

## General Ratings

<b>Amperage</b>	20 to 200A
<b>Voltage</b>	600 VAC (480 VAC for DS200) 250 VDC
<b>Frequency</b>	50-400 Hz
<b>Horsepower</b>	1/2 to 25 hp
<b>Short-Circuit (Make &amp; Withstand)</b>	65kA to 100kA*
<b>Environmental</b>	NEMA 3R, IP54/55**
<b>Temperature</b>	min -40°F/max 140°F

\* DS20, 30, 60 & 100C are rated 100kA. Testing was performed with RK1 current limiting fuses sized at 400% of the highest full load motor ampacity associated with the devices hp rating.

\* DS100 & 200 are rated 65kA. Testing was performed with RK5 time delay fuses sized at 100% of the devices rated ampacity.

\*\* IP54 rated when receptacle and plug are mated, when not mated receptacle alone is IP55 rated provided that the lid is latched closed.

## Listings

Category	UL	CSA	IEC
Plugs and Receptacles	UL 1682	C22.2 No. 182.1	60309-1
Branch Circuit Disconnect Switching (AC only)	UL Subject 2682 (Performance tested to UL 98)	UL Subject 2682	60947-3, AC22, AC23
Motor Circuit Disconnect Switching (AC only)	UL Subject 2682 (Performance tested to UL 508)	UL Subject 2682	

CE ratings available upon request

Courtesy of Gross Automation 1724 South Johnson Road New Berlin, WI PH: 262-446-0000 FAX: 262-446-0300 www.meltricsales.com

## Operating Instructions



When the plug and receptacle are latched together, the circuit is connected.

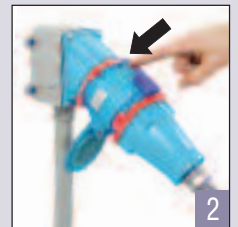

Pressing the pawl causes the DECONTACTOR to break the circuit. The plug is ejected to its rest position; its contacts are now dead.

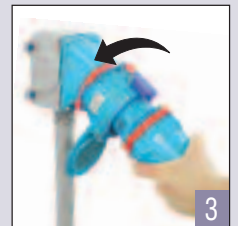

Rotating the 'dead' plug 30° counterclockwise closes the safety shutter and frees the plug to be withdrawn from the receptacle.



The plug and the receptacle are separated. The safety shutter prevents access to live parts.

5 To reconnect, insert plug into receptacle, rotate 30° clockwise, and apply insertion force.

## Highlighted Feature

### Typical Device Labels

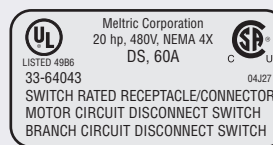

DS Decontactors are UL & CSA rated for "motor circuit" and "branch circuit" disconnect switching – up to 25 hp and up to 200A



# DECONTACTOR™ – 20A

## Switch Rated Plugs & Receptacles

### Ratings

- Voltage**  
600VAC, 250VDC
- Switch Ratings (AC Only)**  
Branch Circuit & Motor Circuit Disconnect Switching
- Horsepower ratings**

120V	1Ø	1/2 hp
208V	3Ø	3 hp
240V	3Ø	1 1/2 hp
480V	3Ø	5 hp
600V	3Ø	7 1/2 hp
- Short Circuit Rating**  
100kA Close & Withstand  
Testing was performed with RK1 current limiting fuses sized at 400% of the highest full load motor ampacity associated with the devices hp rating.
- Environmental Ratings**  
NEMA 3R, IP54/55\*  
\* IP54 when the plug & receptacle are mated. IP55 on the receptacle alone when the lid is latched closed.
- Temperature Range**  
Min -40°F/Max 140°F  
See pg 194 for temps below -15°F.
- Wiring Capacity**  
Min 14 AWG Max 8 AWG  
Aux Contacts - Max 8 AWG
- Listings**  
UL, CSA, IEC, CE\*  
\* Contact Customer Service

### Receptacle (female)



*Don't forget to add installation accessories to your order*

### Inlet (male)

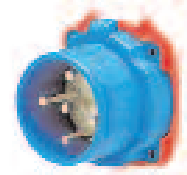

Voltage	Polarity	Part # Poly
120/208V	3P+N+E	33-14167
125V	1P+N+E	33-14075
125/250V	2P+N+E	33-14076
208V	2P+E	33-14162
208V	3P+E	33-14163
250V	2P+E	33-14072
250V	3P+E	33-14073
277V	1P+N+E	33-14045
277/480V	3P+N+E	33-14047
347/600V	3P+N+E	33-14147
480V	2P+E	33-14042
480V	3P+E	33-14043
600V	2P+E	33-14142
600V	3P+E	33-14143

Voltage	Polarity	Part # Poly
120/208V	3P+N+E	33-18167
125V	1P+N+E	33-18075
125/250V	2P+N+E	33-18076
208V	2P+E	33-18162
208V	3P+E	33-18163
250V	2P+E	33-18072
250V	3P+E	33-18073
277V	1P+N+E	33-18045
277/480V	3P+N+E	33-18047
347/600V	3P+N+E	33-18147
480V	2P+E	33-18042
480V	3P+E	33-18043
600V	2P+E	33-18142
600V	3P+E	33-18143

Other voltage configurations are available – contact customer service at 800.433.7642.

### Main Options



**Auxiliary/Pilot Contacts**



**Emergency Stop Pawl**



**Padlockable Mushroom Pawl**



**Self-Ejecting Devices**

\* Requires straight insertion receptacle or inlet and self-ejecting plug or connector

See pgs 171-180 for detailed information on these options

### Receptacle Options

### Suffix #

With 2 Auxiliary/Pilot Contacts	Recept # - 972
LP Watertightness (low pressure)	Recept # - LP
HP Watertightness (high pressure)	Recept # - HP
Straight Insertion	Recept # - A188
Self-Ejecting Connector Release	Recept # - 348-A188
Emergency Stop Pawl	Recept # - 375
Locking Mushroom Pawl	Recept # - 845
Padlockable Mushroom Pawl	Recept # - 843
Metal Pawl (on poly receptacle)	Recept # - 824
Closed Lid Configuration	Recept # - NC
With Auxiliary Switch	Recept # - 270

### Inlet Options

### Suffix #

With 2 Auxiliary/Pilot Contacts	Inlet # - 972
LP Watertightness (low pressure)	Inlet # - LP
HP Watertightness (high pressure)	Inlet # - HP
Self-Ejecting Plug Release	Inlet # - 338-A188
Straight Insertion	Inlet # - A188
With No Lockout Hole	Inlet # - A155
With Spring-Loaded Cap	Inlet # - 226
For Auxiliary Switch	Inlet # - NNF

#### DS20 Order Example:

To order 2 auxiliary/pilot contacts on an inlet and receptacle add **-972** to the part numbers.

DS20 Poly inlet 2P+E=33-18162-**972**

DS20 Poly receptacle 2P+E=33-14162-**972**

Appropriate accessory part numbers must also be included on the order.

# Installation Accessories

## Handles



Not NEMA 3R

NPT	Poly Handle	Cable Range	Poly Handle w/Clamp & Bushing	Nylon Handle	Neoprene Handle
1/2"	1PH12	.20 - .83	-	FH111	-
3/4"	1PH34	.32 - .88	-	-	31-111
1"	1PH1	.750 - .875	1PM514	-	-
1 1/4"	1PH114	.875 - 1.000	1PM516	-	-
		1.000 - 1.125	1PM518	-	-
		1.125 - 1.250	1PM520	-	-
		1.250 - 1.375	1PM522	-	-

**Notes:** • Finger draw plates are recommended for easier connector closure on cord to cord assemblies.  
• For available cord grips, see pgs 167-168.

## Angles



Nylon 30° Angle	Metal 30° Angle	Metal Angle FS/FD Box 30°	Metal Straight Adapter
MP2	MA2	MAFS2	MS2

## NPT Guidelines

Cable Range	NPT	Cable Range	NPT
.062 - .5	1/2"	.890 - 1.650	1 1/2"
.187 - .75	3/4"	1.125 - 2.438	2"
.437 - 1.10	1"	1.750 - 2.565	2 1/2"
.750 - 1.375	1 1/4"		

NPT sizes are determined by the cable diameter and third party cord grip.

## Junction Boxes



NPT	Metal Box	Metal Box with Nylon Angle	Poly* Conduit Entry
1/2"	MB312	31-1A053-080-12	MC212
3/4"	MB334	31-1A053-080-34	MC234
1"	MB31	31-1A053-080-1	-
1 1/4"	MB3114	31-1A053-080-114	-

\* For poly devices only

## Miscellaneous Accessories



\* Set of Two (2)



For Male Devices Only



For Male Devices Only



Finger Drawplates	Protective Cap	Padlockable Plug Cap Poly	Inlet Spring-Loaded Cap
FDP2	31-1A126	DS1PC	31-1A226

\* Recommended for cord to cord assembly applications, for easier connector closure

## Order Example

A typical order should include an inlet part number, a receptacle part number **AND** the matching handles, angles or other required accessories.

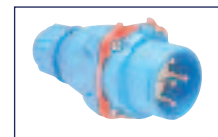

Male Inlet with Handle (Plug)  
33-18075 + FH111



Female Receptacle with Angle Adapter  
33-14075 + MP2



# DECONTACTOR™ – 30A

## Switch Rated Plugs & Receptacles

### Ratings

- Voltage**  
600VAC, 250VDC
- Switch Ratings (AC Only)**  
Branch Circuit & Motor Circuit Disconnect Switching
- Horsepower ratings**
  - 120V 1Ø 3/4 hp
  - 240V 1Ø 2 hp
  - 208V 3Ø 3 hp
  - 240V 3Ø 3 hp
  - 480V 3Ø 10 hp
- Short Circuit Rating**  
100kA Close & Withstand  
Testing was performed with RK1 current limiting fuses sized at 400% of the highest full load motor ampacity associated with the devices hp rating.
- Environmental Ratings**  
NEMA 3R, IP54/55\*  
\* IP54 when the plug & receptacle are mated. IP55 on the receptacle alone when the lid is latched closed.
- Temperature Range**  
Min -40°F/Max 140°F  
See pg 194 for temps below -15°F.
- Wiring Capacity**  
Min 12 AWG Max 4 AWG  
Aux Contacts - Max 12 AWG
- Listings**  
UL, CSA, IEC, CE\*  
\* Contact Customer Service

### Receptacle (female)



*Don't forget to add installation accessories to your order*

### Inlet (male)

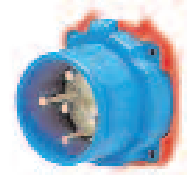

Voltage	Polarity	Part # Poly
120/208V	3P+N+E	33-34167
125V	1P+N+E	33-34075
125/250V	2P+N+E	33-34076
208V	2P+E	33-34162
208V	3P+E	33-34163
250V	2P+E	33-34072
250V	3P+E	33-34073
277V	1P+N+E	33-34045
277/480V	3P+N+E	33-34047
347/600V	3P+N+E	33-34147
480V	2P+E	33-34042
480V	3P+E	33-34043
600V	2P+E	33-34142
600V	3P+E	33-34143

Voltage	Polarity	Part # Poly
120/208V	3P+N+E	33-38167
125V	1P+N+E	33-38075
125/250V	2P+N+E	33-38076
208V	2P+E	33-38162
208V	3P+E	33-38163
250V	2P+E	33-38072
250V	3P+E	33-38073
277V	1P+N+E	33-38045
277/480V	3P+N+E	33-38047
347/600V	3P+N+E	33-38147
480V	2P+E	33-38042
480V	3P+E	33-38043
600V	2P+E	33-38142
600V	3P+E	33-38143

Other voltage configurations are available – contact customer service at 800.433.7642.

### Main Options



**Auxiliary/Pilot Contacts**



**Emergency Stop Pawl**



**Padlockable Mushroom Pawl**



**Self-Ejecting Devices**

\* Requires straight insertion receptacle or inlet and self-ejecting plug or connector

See pgs 171-180 for detailed information on these options

### Receptacle Options

### Suffix #

With 2 Auxiliary/Pilot Contacts	Recept # - 972
With 3 Auxiliary/Pilot Contacts	Recept # - 973
With 4 Auxiliary/Pilot Contacts	Recept # - 974
LP Watertightness (low pressure)	Recept # - LP
HP Watertightness (high pressure)	Recept # - HP
Straight Insertion	Recept # - A188
Self-Ejecting Connector Release	Recept # - 348-A188
Emergency Stop Pawl	Recept # - 375
Locking Mushroom Pawl	Recept # - 845
Padlockable Mushroom Pawl	Recept # - 843
Metal Pawl (on poly receptacle)	Recept # - 824
Closed Lid Configuration	Recept # - NC
With Auxiliary Switch	Recept # - 270
Recess Plate	Recept # - 142

### Inlet Options

### Suffix #

With 2 Auxiliary/Pilot Contacts	Inlet # - 972
With 3 Auxiliary/Pilot Contacts	Inlet # - 973
With 4 Auxiliary/Pilot Contacts	Inlet # - 974
LP Watertightness (low pressure)	Inlet # - LP
HP Watertightness (high pressure)	Inlet # - HP
Self-Ejecting Plug Release	Inlet # - 338-A188
Straight Insertion	Inlet # - A188
With No Lockout Hole	Inlet # - A155
With Spring-Loaded Cap	Inlet # - 226
For Auxiliary Switch	Inlet # - NNF

#### DS30 Order Example:

To order 2 auxiliary contacts on an inlet and receptacle add **-972** to the part numbers.

DS30 Poly inlet 3P+E=33-38043-972

DS30 Poly receptacle 3P+E=33-34043-972

Appropriate accessory part numbers must also be included on the order.

# Installation Accessories

## Handles



Not NEMA 3R

Makes connector closures easier

NPT	Poly Handle	Cable Range	Poly Handle w/Clamp & Bushing	Nylon Handle	Neoprene Handle	Poly Handle w/built in Draw Grips
1/2"	3PH12	.38 - 1.12	-	-	31-311	-
3/4"	3PH34	.39 - 1.18	-	FH311	-	FH311-473
1"	3PH1	.750 - .875	3PM514	-	-	-
1 1/4"	3PH114	.875 - 1.000	3PM516	-	-	-
		1.000 - 1.125	3PM518	-	-	-
		1.125 - 1.250	3PM520	-	-	-
		1.250 - 1.375	3PM522	-	-	-

**Notes:** • Finger draw plates are recommended for easier connector closure on cord to cord assemblies.  
• For available cord grips, see pgs 167-168.

## Angles



Nylon 30° Angle	Metal 30° Angle	Metal 70° Angle	Metal Angle FS/FD Box 30°	Metal Straight Adapter
MP3	MA3	89-3A027	MAFS3	MS3

## NPT Guidelines

Cable Range	NPT	Cable Range	NPT
.062 - .5	1/2"	.890 - 1.650	1 1/2"
.187 - .75	3/4"	1.125 - 2.438	2"
.437 - 1.10	1"	1.750 - 2.565	2 1/2"
.750 - 1.375	1 1/4"		

NPT sizes are determined by the cable diameter and third party cord grip.

## Junction Boxes



NPT	Metal Box	Metal Box with Nylon Angle	Poly* Conduit Entry
1/2"	MB312	31-3A053-080-12	MC312
3/4"	MB334	31-3A053-080-34	MC334
1"	MB31	31-3A053-080-1	MC31
1 1/4"	MB3114	31-3A053-080-114	-

\* For poly devices only

## Miscellaneous Accessories



\* Set of Two (2)



For Male Devices Only



For Male Devices Only



Finger Drawplates	Protective Cap	Padlockable Plug Cap Poly	Inlet Spring-Loaded Cap
FDP3	31-3A126	DS3PC	31-3A226

\* Recommended for cord to cord assembly applications, for easier connector closure

## Order Example

A typical order should include an inlet part number, a receptacle part number **AND** the matching handles, angles or other required accessories.

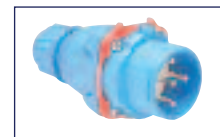

Male Inlet with Handle (Plug)  
33-38043 + FH311



Female Receptacle with Angle Adapter  
33-34043 + MP3



# DECONTACTOR™ – 60A

## Switch Rated Plugs & Receptacles

### Ratings

- Voltage**  
600 VAC, 250 VDC
- Switch Ratings (AC Only)**  
Branch Circuit & Motor Circuit Disconnect Switching
- Horsepower ratings**

120V	1Ø	2 hp
240V	1Ø	3 hp
208V	3Ø	7 1/2 hp
240V	3Ø	7 1/2 hp
480V	3Ø	20 hp
600V	3Ø	25 hp
- Short Circuit Rating**  
100kA Close & Withstand  
Testing was performed with RK1 current limiting fuses sized at 400% of the highest full load motor ampacity associated with the devices hp rating.
- Environmental Ratings**  
NEMA 3R, IP54/55\*  
\* IP54 when the plug & receptacle are mated. IP55 on the receptacle alone when the lid is latched closed.
- Temperature Range**  
Min -40°F/Max 140°F  
See pg 194 for temps below -15°F.
- Wiring Capacity**  
Min 6 AWG Max 2 AWG  
Aux Contacts - Max 14 AWG
- Listings**  
UL, CSA, IEC, CE\*  
\* Contact Customer Service

### Receptacle (female)



*Don't forget to add installation accessories to your order*

### Inlet (male)

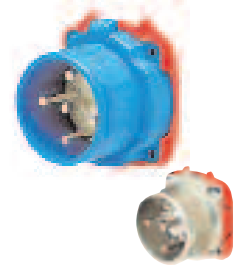

Voltage	Polarity	Part #	
		Poly	Metal
120/208V	3P+N+E	33-64167	37-64167
125V	1P+N+E	33-64075	37-64075
125/250V	2P+N+E	33-64076	37-64076
208V	2P+E	33-64162	37-64162
208V	3P+E	33-64163	37-64163
250V	2P+E	33-64072	37-64072
250V	3P+E	33-64073	37-64073
277V	1P+N+E	33-64045	37-64045
277/480V	3P+N+E	33-64047	37-64047
347/600V	3P+N+E	33-64147	37-64147
480V	2P+E	33-64042	37-64042
480V	3P+E	33-64043	37-64043
600V	2P+E	33-64142	37-64142
600V	3P+E	33-64143	37-64143

Voltage	Polarity	Part #	
		Poly	Metal
120/208V	3P+N+E	33-68167	37-68167
125V	1P+N+E	33-68075	37-68075
125/250V	2P+N+E	33-68076	37-68076
208V	2P+E	33-68162	37-68162
208V	3P+E	33-68163	37-68163
250V	2P+E	33-68072	37-68072
250V	3P+E	33-68073	37-68073
277V	1P+N+E	33-68045	37-68045
277/480V	3P+N+E	33-68047	37-68047
347/600V	3P+N+E	33-68147	37-68147
480V	2P+E	33-68042	37-68042
480V	3P+E	33-68043	37-68043
600V	2P+E	33-68142	37-68142
600V	3P+E	33-68143	37-68143

Other voltage configurations are available – contact customer service at 800.433.7642.

### Main Options

- Auxiliary/Pilot Contacts
- Emergency Stop Pawl
- Padlockable Mushroom Pawl
- Self-Ejecting Devices  
\* Requires straight insertion receptacle or inlet and self-ejecting plug or connector

See pgs 171-180 for detailed information on these options

### Receptacle Options

### Suffix #

- With 2 Auxiliary/Pilot Contacts Recept # - 972
- With 3 Auxiliary/Pilot Contacts Recept # - 263
- LP Watertightness (low pressure) Recept # - LP
- HP Watertightness (high pressure) Recept # - HP
- Straight Insertion Recept # - A188
- Self-Ejecting Connector Release Recept # - 348-A188
- Emergency Stop Pawl Recept # - 375
- Locking Mushroom Pawl Recept # - 845
- Padlockable Mushroom Pawl Recept # - 843
- Metal Pawl (on poly receptacle) Recept # - 824
- Closed Lid Configuration Recept # - NC
- With Auxiliary Switch Recept # - 270
- Recess Plate Recept # - 142

### Inlet Options

### Suffix #

- With 2 Auxiliary/Pilot Contacts Inlet # - 972
- With 3 Auxiliary/Pilot Contacts Inlet # - 263
- LP Watertightness (low pressure) Inlet # - LP
- HP Watertightness (high pressure) Inlet # - HP
- Self-Ejecting Plug Release Inlet # - 338-A188
- Straight Insertion Inlet # - A188
- With No Lockout Hole Inlet # - A155
- For Auxiliary Switch Inlet # - NNF

#### DS60 Order Example:

To order 2 auxiliary/pilot contacts on an inlet and receptacle add **-972** to the part numbers.

DS60 Poly inlet 3P+E=33-68043-972

DS60 Poly receptacle 3P+E=33-64043-972

Appropriate accessory part numbers must also be included on the order.

# Installation Accessories

Unless indicated otherwise, accessories can be used with either poly or metal plugs and receptacles

## Handles



NPT	Poly Handle	Metal* Handle	Cable Range	Poly Handle w/Clamp & Bushing	Nylon Handle	Neoprene Handle	Poly Handle w/built in Draw Grips
1/2"	6PH12	6H12	.50 - 1.25	-	-	31-611	-
3/4"	6PH34	6H34	.51 - 1.38	-	FH611	-	FH611-473
1"	6PH1	6H1	1.250 - 1.375	6PM622	-	-	-
1 1/4"	6PH114	6H114	1.438 - 1.562	6PM625	-	-	-
1 1/2"	6PH112	6H112	1.562 - 1.688	6PM627	-	-	-
			1.688 - 1.812	6PM629	-	-	-

**Notes:** • For available cord grips, see pgs 167-168.  
\* For metal devices only

• For a guideline of NPT sizes based on cable ranges, see DS30 on pg 38.

## Angles



Nylon 30° Angle	Metal 30° Angle	Metal 70° Angle	Metal Angle Oversized 30°	Metal Straight Adapter	Metal Lateral Angle 30°
MP6	MA6	89-6A027	MA660	MS6	MAB6

## Junction Boxes



NPT	Metal Box	Metal Box with Nylon Angle	Metal Box with Metal Angle	Poly* Conduit Entry
1/2"	-	-	-	MC612
3/4"	-	-	-	MC634
1"	MB61	31-6A053-080-1	39-6A053-080-1	MC61
1 1/4"	MB6114	31-6A053-080-114	39-6A053-080-114	MC6114
1 1/2"	MB6112	31-6A053-080-112	39-6A053-080-112	-
2"	MB62	31-6A053-080-2	39-6A053-080-2	-

\* For poly devices only

## Miscellaneous Accessories



Finger Drawplates	Protective Cap	Padlockable Plug Cap Poly	Padlockable Cap Aluminum	Inlet Spring-Loaded cap	Cord Grip with Mesh
FDP6	31-6A126	DS6PC	DS6MC	31-6A226	see pgs 167-168

## Accessory Spotlight

### Finger Drawplates



Finger drawplates are recommended for easier connector closure on cord to cord assemblies.

## Order Example

A typical order should include an inlet part number, a receptacle part number **AND** the matching handles, angles or other required accessories.

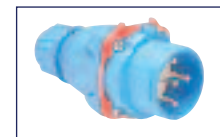

Male Inlet with Handle (Plug)  
33-68043 + FH611



Female Receptacle with Angle Adapter  
33-64043 + MP6





# DECONTACTOR™ – 100A

## Switch Rated Plugs & Receptacles

### Ratings

- Voltage**  
600 VAC, 250 VDC
- Switch Ratings (AC Only)**  
Branch Circuit & Motor Circuit Disconnect Switching
- Horsepower Ratings**

120V	1Ø	2 hp
240V	1Ø	3 hp
208V	3Ø	7 1/2 hp
240V	3Ø	7 1/2 hp
480V	3Ø	20 hp
600V	3Ø	25 hp
- Short Circuit Rating**  
100kA Close & Withstand  
Testing was performed with RK1 current limiting fuses sized at 400% of the highest full load motor ampacity associated with the devices hp rating.
- Environmental Ratings**  
NEMA 3R, IP54/55\*  
\* IP54 when the plug & receptacle are mated. IP55 on the receptacle alone when the lid is latched closed.
- Temperature Range**  
Min -40°F/Max 140°F  
See pg 194 for temps below -15°F.
- Wiring Capacity**  
Min 6 AWG Max 2 AWG  
Aux Contacts - Max 14 AWG
- Listings**  
UL, CSA, IEC, CE\*  
\* Contact Customer Service

### Receptacle (female)



*Don't forget to add installation accessories to your order*

### Inlet (male)

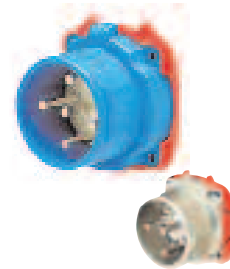

Voltage	Polarity	Part #	
		Poly	Metal
120/208V	3P+N+E	33-64237-C-K16	37-64237-C-K16
125V	1P+N+E	33-64175-C-K07	37-64175-C-K07
125/250V	2P+N+E	33-64176-C-K07	37-64176-C-K07
208V	2P+E	33-64232-C-K16	37-64232-C-K16
208V	3P+E	33-64233-C-K16	37-64233-C-K16
250V	2P+E	33-64172-C-K07	37-64172-C-K07
250V	3P+E	33-64173-C-K07	37-64173-C-K07
277V	1P+N+E	33-64245-C-K04	37-64245-C-K04
277/480V	3P+N+E	33-64247-C-K04	37-64247-C-K04
347/600V	3P+N+E	33-64187-C-K14	37-64187-C-K14
480V	2P+E	33-64242-C-K04	37-64242-C-K04
480V	3P+E	33-64243-C-K04	37-64243-C-K04
600V	2P+E	33-64182-C-K14	37-64182-C-K14
600V	3P+E	33-64183-C-K14	37-64183-C-K14

Voltage	Polarity	Part #	
		Poly	Metal
120/208V	3P+N+E	33-68237-C-K16	37-68237-C-K16
125V	1P+N+E	33-68175-C-K07	37-68175-C-K07
125/250V	2P+N+E	33-68176-C-K07	37-68176-C-K07
208V	2P+E	33-68232-C-K16	37-68232-C-K16
208V	3P+E	33-68233-C-K16	37-68233-C-K16
250V	2P+E	33-68172-C-K07	37-68172-C-K07
250V	3P+E	33-68173-C-K07	37-68173-C-K07
277V	1P+N+E	33-68245-C-K04	37-68245-C-K04
277/480V	3P+N+E	33-68247-C-K04	37-68247-C-K04
347/600V	3P+N+E	33-68187-C-K14	37-68187-C-K14
480V	2P+E	33-68242-C-K04	37-68242-C-K04
480V	3P+E	33-68243-C-K04	37-68243-C-K04
600V	2P+E	33-68182-C-K14	37-68182-C-K14
600V	3P+E	33-68183-C-K14	37-68183-C-K14

Other voltage configurations are available – contact customer service at 800.433.7642.

### Main Options



**Auxiliary/Pilot Contacts**



**Emergency Stop Pawl**



**Padlockable Mushroom Pawl**



**Self-Ejecting Devices**

*\* Requires straight insertion receptacle or inlet and self-ejecting plug or connector*

See pgs 171-180 for detailed information on these options

### Receptacle Options

### Suffix #

With 2 Auxiliary/Pilot Contacts	Recept # - 972
With 3 Auxiliary/Pilot Contacts	Recept # - 263
LP Watertightness (low pressure)	Recept # - LP
HP Watertightness (high pressure)	Recept # - HP
Straight Insertion	Recept # - A188
Self-Ejecting Connector Release	Recept # - 348-A188
Emergency Stop Pawl	Recept # - 375
Locking Mushroom Pawl	Recept # - 845
Padlockable Mushroom Pawl	Recept # - 843
Metal Pawl (on poly receptacle)	Recept # - 824
Closed Lid Configuration	Recept # - NC
With Auxiliary Switch	Recept # - 270
Recess Plate	Recept # - 142

### Inlet Options

### Suffix #

With 2 Auxiliary/Pilot Contacts	Inlet # - 972
With 3 Auxiliary/Pilot Contacts	Inlet # - 263
LP Watertightness (low pressure)	Inlet # - LP
HP Watertightness (high pressure)	Inlet # - HP
Self-Ejecting Plug Release	Inlet # - 338-A188
Straight Insertion	Inlet # - A188
With No Lockout Hole	Inlet # - A155
With Spring-Loaded Cap	Inlet # - 226
For Auxiliary Switch	Inlet # - NNF

#### DS100C Order Example:

To order 2 auxiliary/pilot contacts on an inlet and receptacle add **-972** to the part numbers.

DS100C Poly inlet 3P+E=33-68243-C-K04-**972**

DS100C Poly receptacle 3P+E=33-64243-C-K04-**972**

Appropriate accessory part numbers must also be included on the order.

# Installation Accessories

Unless indicated otherwise, accessories can be used with either poly or metal plugs and receptacles

## Handles



NPT	Poly Handle	Metal* Handle	Cable Range	Poly Handle w/Clamp & Bushing	Nylon Handle	Neoprene Handle	Poly Handle w/built in Draw Grips
1/2"	6PH12	6H12	.50 - 1.25	-	-	31-611	-
3/4"	6PH34	6H34	.51 - 1.38	-	FH611	-	FH611-473
1"	6PH1	6H1	1.250 - 1.375	6PM622	-	-	-
1 1/4"	6PH114	6H114	1.438 - 1.562	6PM625	-	-	-
1 1/2"	6PH112	6H112	1.562 - 1.688	6PM627	-	-	-
			1.688 - 1.812	6PM629	-	-	-

**Notes:** • Finger draw plates are recommended for easier connector closure on cord to cord assemblies.  
 • For available cord grips, see pgs 167-168.  
 \* For metal devices only

• For a guideline of NPT sizes based on cable ranges, see DS30 on pg 38.

## Angles



Nylon 30° Angle	Metal 30° Angle	Metal 70° Angle	Metal Angle Oversized 30°	Metal Straight Adapter	Metal Lateral Angle 30°
MP6	MA6	89-6A027	MA660	MS6	MAB6

## Junction Boxes



NPT	Metal Box	Metal Box with Nylon Angle	Metal Box with Metal Angle	Poly* Conduit Entry
1/2"	-	-	-	MC612
3/4"	-	-	-	MC634
1"	MB61	31-6A053-080-1	39-6A053-080-1	MC61
1 1/4"	MB6114	31-6A053-080-114	39-6A053-080-114	MC6114
1 1/2"	MB6112	31-6A053-080-112	39-6A053-080-112	-
2"	MB62	31-6A053-080-2	39-6A053-080-2	-

\* For poly devices only

## Miscellaneous Accessories



Set of Two (2)

For Male Devices Only

For Male Devices Only

Finger Drawplates	Protective Cap	Padlockable Cap	Inlet Spring-Loaded cap
FDP6	31-6A126	DS6MC	31-6A226

## Accessory Spotlight

### Finger Drawplates



Finger drawplates are recommended for easier connector closure on cord to cord assemblies.

## Order Example

A typical order should include an inlet part number, a receptacle part number **AND** the matching handles, angles or other required accessories.

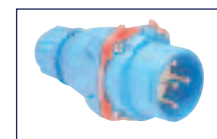

Male Inlet with Handle (Plug)  
33-68243-C-K04 + FH611



Female Receptacle with Angle Adapter  
33-64243-C-K04 + MP6



# DECONTACTOR™ – 100A

## Switch Rated Plugs & Receptacles

### Ratings

- Voltage**  
600 VAC, 250 VDC
- Switch Rating (AC Only)**  
Branch Circuit  
Disconnect Switching
- Short Circuit Rating**  
65kA Close & Withstand  
Testing was performed with RK5 time delay fuses sized at 100% of the devices rated ampacity.
- Environmental Ratings**  
NEMA 3R, IP54/55\*  
\* IP54 when the plug & receptacle are mated. IP55 on the receptacle alone when the lid is latched closed.
- Temperature Range**  
Min -40°F/Max 140°F  
See pg 194 for temps below -15°F.
- Wiring Capacity**  
Min 4 AWG Max 2/0 AWG\*  
Aux Contacts - Max 14 AWG  
\* Is available upon request by adding suffix "E323" to the inlet or receptacle.
- Listings**  
UL, CSA, IEC, CE\*  
\* Contact Customer Service

### Receptacle (female)



### Inlet (male)



Voltage	Polarity	Part #	
		Poly	Metal
120/208V	3P+N+E	33-94167	37-94167
125V	1P+N+E	33-94075	37-94075
125/250V	2P+N+E	33-94076	37-94076
208V	2P+E	33-94162	37-94162
208V	3P+E	33-94163	37-94163
250V	2P+E	33-94072	37-94072
250V	3P+E	33-94073	37-94073
277V	1P+N+E	33-94045	37-94045
277/480V	3P+N+E	33-94047	37-94047
347/600V	3P+N+E	33-94147	37-94147
480V	2P+E	33-94042	37-94042
480V	3P+E	33-94043	37-94043
600V	2P+E	33-94142	37-94142
600V	3P+E	33-94143	37-94143

Voltage	Polarity	Part #	
		Poly	Metal
120/208V	3P+N+E	33-98167	37-98167
125V	1P+N+E	33-98075	37-98075
125/250V	2P+N+E	33-98076	37-98076
208V	2P+E	33-98162	37-98162
208V	3P+E	33-98163	37-98163
250V	2P+E	33-98072	37-98072
250V	3P+E	33-98073	37-98073
277V	1P+N+E	33-98045	37-98045
277/480V	3P+N+E	33-98047	37-98047
347/600V	3P+N+E	33-98147	37-98147
480V	2P+E	33-98042	37-98042
480V	3P+E	33-98043	37-98043
600V	2P+E	33-98142	37-98142
600V	3P+E	33-98143	37-98143

Other voltage configurations are available – contact customer service at 800.433.7642.

### Main Options

- Auxiliary/Pilot Contacts
- Emergency Stop Pawl
- Padlockable Mushroom Pawl
- Self-Ejecting Devices  
\* Requires straight insertion receptacle or inlet and self-ejecting plug or connector

See pgs 171-180 for detailed information on these options

### Receptacle Options

### Suffix #

- With 2 Auxiliary/Pilot Contacts Recept # - 172
- With 3 Auxiliary/Pilot Contacts Recept # - 173+
- With 4 Auxiliary/Pilot Contacts Recept # - 174+
- With 5 Auxiliary/Pilot Contacts Recept # - 175+
- LP Watertightness (low pressure) Recept # - LP
- HP Watertightness (high pressure) Recept # - HP
- Straight Insertion Recept # - A188
- Self-Ejecting Connector Release Recept # - 348-A188
- Emergency Stop Pawl Recept # - 375
- Locking Mushroom Pawl Recept # - 845
- Padlockable Mushroom Pawl Recept # - 843
- Metal Pawl (on poly receptacle) Recept # - 824
- 180° Opening Lid Recept # - 180
- Closed Lid Configuration Recept # - NC
- With Auxiliary Switch Recept # - 270

Notes: + DS100 devices with 3 or more auxiliary/pilot contacts are not UL/CSA listed

### Inlet Options

### Suffix #

- With 2 Auxiliary/Pilot Contacts Inlet # - 172
- With 3 Auxiliary/Pilot Contacts Inlet # - 173+
- With 4 Auxiliary/Pilot Contacts Inlet # - 174+
- With 5 Auxiliary/Pilot Contacts Inlet # - 175+
- LP Watertightness (low pressure) Inlet # - LP
- HP Watertightness (high pressure) Inlet # - HP
- Self-Ejecting Plug Release Inlet # - 338-A188
- Straight Insertion Inlet # - A188
- With No Lockout Hole Inlet # - A155
- For Auxiliary Switch Inlet # - NNF

#### DS100 Order Example:

To order 2 auxiliary/pilot contacts on an inlet and receptacle add -172 to the part numbers.

DS100 Poly inlet 3P+E=33-98043-172

DS100 Poly receptacle 3P+E=33-94043-172

Appropriate accessory part numbers must also be included on the order.

# Installation Accessories

Unless indicated otherwise, accessories can be used with either poly or metal plugs and receptacles

## Handles



IP 66/67

NPT	Poly Handle	Metal* Handle
3/4"	9PH34	9H34
1"	9PH1	9H1
1 1/4"	9PH114	9H114
1 1/2"	9PH112	9H112
2"	9PH2	9H2

Cable Range	Poly Handle w/Clamp & Bushing	Santoprene™ Handle
.70 - 1.00	–	65-9A013-D25
1.00 - 1.375	–	65-9A013-D35
1.250 - 1.375	9PM622	–
1.375 - 1.750	–	65-9A013-D45
1.438 - 1.562	9PM625	–
1.562 - 1.688	9PM627	–
1.688 - 1.812	9PM629	–

- Notes:**
- Finger draw plates are recommended for easier connector closure on cord to cord assemblies.
  - For available cord grips, see pgs 167-168.
  - \* For metal devices only

- For a guideline of NPT sizes based on cable ranges, see DS30 on pg 38.

## Angles



Nylon 30° Angle	Metal 30° Angle	Metal 70° Angle	Metal Angle Oversized 30°	Metal Straight Adapter
MP10	MA10	89-9A027	MA110	MS10

## Junction Boxes



NPT	Metal Box	Metal Box with Nylon Angle	Metal Box with Metal Angle
1 1/4"	MB10114	31-9A053-080-114	39-9A053-080-114
1 1/2"	MB10112	31-9A053-080-112	39-9A053-080-112
2"	MB102	31-9A053-080-2	39-9A053-080-2
2 1/2"	MB10212	31-9A053-080-212	39-9A053-080-212

## Miscellaneous Accessories



Removable Drawbar Complete Kit *	1 Drawbar	1 Plate	Permanent Drawbar Complete Kit **	1 Drawbar 1 Attached Plate	1 Plate
NT100	NT110	NT120	39-9A486	39-9A024-486	39-9A014-486

\* Consists of 1 Drawbar and 2 Plates

\*\* Consists of 1 Drawbar with Attached Plate and 1 additional Plate

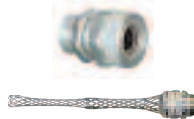

\* Set of Two (2)

For Male Devices Only

For Male Devices Only

Finger Drawplates	Protective Cap	Padlockable Cap Aluminum	Cord Grip with Mesh
FDP9SS	31-9A126	DS9MC	see pgs 167-168

\* Recommended for cord to cord assembly applications, for easier connector closure

## Order Example

A typical order should include an inlet part number, a receptacle part number **AND** the matching handles, angles or other required accessories.



Male Inlet with Handle (Plug)  
37-98043 + 65-9A013-D25



Female Receptacle with Angle Adapter  
37-94043 + MA10



## DECONTACTOR™ – 200A Switch Rated Plugs & Receptacles

### Ratings

- Voltage**  
480 VAC
- Switch Ratings (AC Only)**  
Branch Circuit  
Disconnect Switching
- Short Circuit Rating**  
65kA Close & Withstand  
Testing was performed with RK5  
time delay fuses sized at 100% of  
the devices rated ampacity.
- Environmental Ratings**  
NEMA 3R, IP54/55\*  
\* IP54 when the plug & receptacle are  
mated. IP55 on the receptacle alone  
when the lid is latched closed.
- Temperature Range**  
Min -40°F/Max 140°F  
See pg 194 for temps below -15°F.
- Wiring Capacity**  
Min 4 AWG Max 4/0 AWG\*  
Aux Contacts - Max 14 AWG  
\* Is available upon request by adding  
suffix "A06" to the inlet or receptacle.
- Listings**  
UL, CSA, IEC, CE\*  
\* Contact Customer Service

### Receptacle (female)



### Inlet (male)

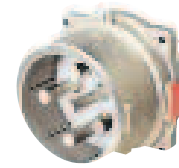

Voltage	Polarity	Part # Metal
120/208V	3P+N+E	37-24167
125V	1P+N+E	37-24075
125/250V	2P+N+E	37-24076
208V	2P+E	37-24162
208V	3P+E	37-24163
250V	2P+E	37-24072
250V	3P+E	37-24073
277V	1P+N+E	37-24045
277/480V	3P+N+E	37-24047
347/600V	3P+N+E	-
480V	2P+E	37-24042
480V	3P+E	37-24043
600V	2P+E	-
600V	3P+E	-

Voltage	Polarity	Part # Metal
120/208V	3P+N+E	37-28167
125V	1P+N+E	37-28075
125/250V	2P+N+E	37-28076
208V	2P+E	37-28162
208V	3P+E	37-28163
250V	2P+E	37-28072
250V	3P+E	37-28073
277V	1P+N+E	37-28045
277/480V	3P+N+E	37-28047
347/600V	3P+N+E	-
480V	2P+E	37-28042
480V	3P+E	37-28043
600V	2P+E	-
600V	3P+E	-

Other voltage configurations are available – contact customer service at 800.433.7642.

### Main Options

- Auxiliary/Pilot Contacts
- Emergency Stop Pawl
- Padlockable Mushroom Pawl
- Self-Ejecting Devices  
\* Requires straight insertion receptacle or inlet and self-ejecting plug or connector

See pgs 171-180 for detailed information on these options

### Receptacle Options

Receptacle Options	Suffix #
With 2 Auxiliary/Pilot Contacts	Recept # - 172
With 3 Auxiliary/Pilot Contacts	Recept # - 173+
With 4 Auxiliary/Pilot Contacts	Recept # - 174+
With 5 Auxiliary/Pilot Contacts	Recept # - 175+
LP Watertightness (low pressure)	Recept # - LP
HP Watertightness (high pressure)	Recept # - HP
Straight Insertion	Recept # - A188
Self-Ejecting Connector Release	Recept # - 348-A188
Emergency Stop Pawl	Recept # - 375
Locking Mushroom Pawl	Recept # - 845
Padlock Pawl	Recept # - 843
180° Opening Lid	Recept # - 180
Closed Lid Configuration	Recept # - NC
With Auxiliary Switch	Recept # - 270

### Inlet Options

Inlet Options	Suffix #
With 2 Auxiliary/Pilot Contacts	Inlet # - 172
With 3 Auxiliary/Pilot Contacts	Inlet # - 173+
With 4 Auxiliary/Pilot Contacts	Inlet # - 174+
With 5 Auxiliary/Pilot Contacts	Inlet # - 175+
LP Watertightness (low pressure)	Inlet # - LP
HP Watertightness (high pressure)	Inlet # - HP
Self-Ejecting Plug Release	Inlet # - 338-A188
Straight Insertion	Inlet # - A188
With No Lockout Hole	Inlet # - A155
For Auxiliary Switch	Inlet # - NNF

#### DS200 Order Example:

To order 2 auxiliary contacts on an inlet and receptacle add **-172** to the part numbers.

DS200 Metal inlet 3P+E=37-28043-172

DS200 Metal receptacle 3P+E=37-24043-172

Appropriate accessory part numbers must also be included on the order.

Notes: + DS200 devices with 3 or more auxiliary/pilot contacts are not UL/CSA listed

# Installation Accessories

## Handles



Not NEMA 3R

NPT	Poly Handle	Metal* Handle	Cable Range	Neoprene Handle
1"	-	2H1	1.50 - 2.25	31-211
1 1/4"	-	2H114		
1 1/2"	2PH112	2H112		
2"	2PH2	2H2		
2 1/2"	2PH212	2H212		

**Notes:** • For available cord grips, see pgs 167-168.

## Angles



Metal 60° Angle	Metal Angle Oversized 45°	Metal Straight Adapter
MA20	MA220	MS20

## Junction Boxes



NPT	Metal Box	Metal Box with Metal Angle
1 1/2"	MB20112	39-2A053-080-112
2"	MB202	39-2A053-080-2
2 1/2"	MB20212	39-2A053-080-212
Oversized	MB22212	-

## NPT Guidelines

Cable Range	NPT
.062 - .5	1/2"
.187 - .75	3/4"
.437 - 1.10	1"
.750 - 1.375	1 1/4"
.890 - 1.650	1 1/2"
1.125 - 2.438	2"
1.750 - 2.565	2 1/2"

NPT sizes are determined by the cable diameter and third party cord grip.

## Miscellaneous Accessories

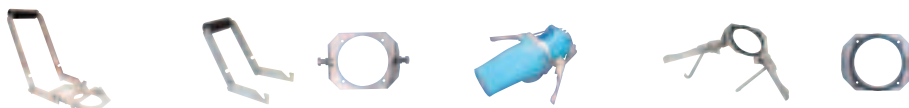

Removable Drawbar Complete Kit *	1 Drawbar	1 Plate	Permanent Drawbar Complete Kit **	1 Drawbar 1 Attached Plate	1 Plate
NT200	NT210	NT220	39-2A486	39-2A024-486	39-2A014-486

\* Consists of 1 Drawbar and 2 Plates

\*\* Consists of 1 Drawbar with Attached Plate and 1 additional Plate



For Male Devices Only



For Male Devices Only

Protective Cap	Padlockable Cap Aluminum
31-2A126	DS2MC

## Order Example

A typical order should include an inlet part number, a receptacle part number **AND** the matching handles, angles or other required accessories.

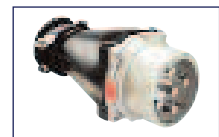

Male Inlet with Handle (Plug)  
37-28043 + 31-211







Female Receptacle with Angle Adapter  
37-24043 + MA20

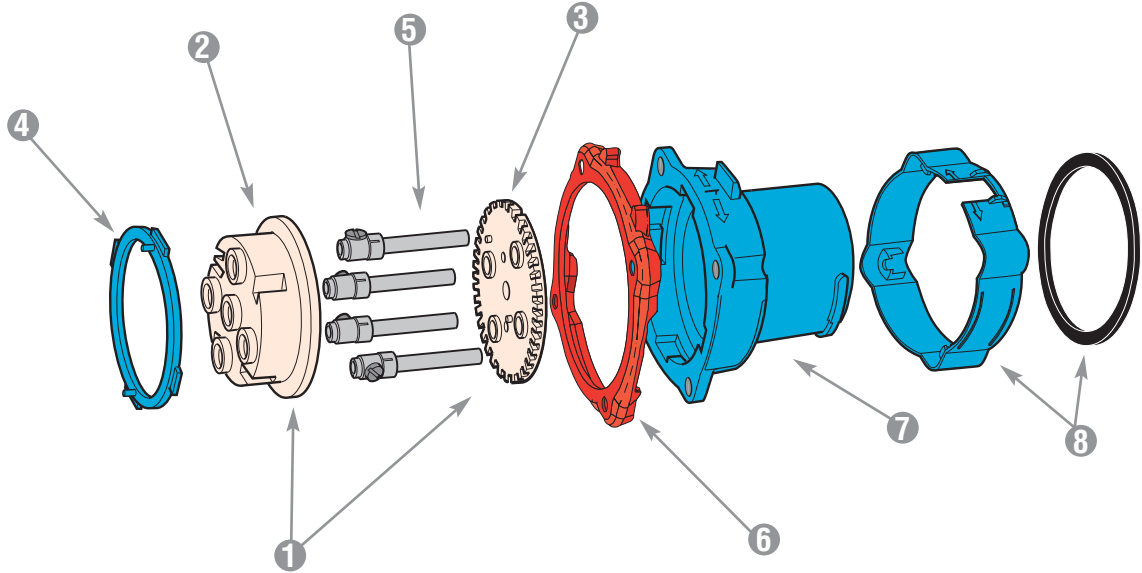

# Spare Parts Male Configuration



	DS20 POLY	DS30 POLY	DS60 POLY	DS60 METAL	DS100C POLY	DS100C METAL	DS100 POLY	DS100 METAL	DS200 METAL
1 = Plug Interior***	31-1A010*	31-3A010*	31-6A010*	31-6A010*	31-6A010-C*	31-6A010-C*	31-9A010*	39-9A010*	39-2A010*
1 = Plug Interior with Ground Contacts	-	-	-	39-6A110*	-	39-6A110-C*	-	39-9A110*	39-2A110*
2 = Interior Bottom	31-1A010-B	31-3A010-B	31-6A010-B	31-6A010-B	31-6A010-C-B	31-6A010-C-B	31-9A010-B	39-9A010-B	39-2A010-B
3 = Interior Top	31-1A010-T*	31-3A010-T*	31-6A010-T*	31-6A010-T*	31-6A010-C-T*	31-6A010-C-T*	31-9A010-T*	39-9A010-T*	39-2A010-T*
4 = Polyester Locking Ring	31-1A583	31-3A583	31-6A583	-	31-6A583	-	31-9A583	-	-
4 = Metal Locking Ring	-	-	-	39-6A583	-	39-6A583	-	39-9A583	39-2A583
5 = Plug Contact	31-1A011	31-3A011-380	31-6A011	31-6A011	31-6A011-C	31-6A011-C	39-9A011	39-9A011	39-2A011
6 = Color-Coded Voltage Gasket	 31-1AB26	31-3AB26	31-6AB26	31-6AB26	31-6AB26	31-6AB26	31-9AB26	31-9AB26	39-2AB26
	 31-1AC26	31-3AC26	31-6AC26	31-6AC26	31-6AC26	31-6AC26	31-9AC26	31-9AC26	39-2AC26
	 31-1AR26	31-3AR26	31-6AR26	31-6AR26	31-6AR26	31-6AR26	31-9AR26	31-9AR26	39-2AR26
	 31-1AN26	31-3AN26	31-6AN26	31-6AN26	31-6AN26	31-6AN26	31-9AN26	31-9AN26	39-2AN26
	 31-1AC26	31-3AC26	31-6AC26	31-6AC26	31-6AC26	31-6AC26	31-9AC26	31-9AC26	39-2AC26
7 = Plug Polyester Casing	31-1A014**	31-3A014**	31-6A014**	-	31-6A014**	-	31-9A014**	-	-
7 = Plug Metal Casing	-	-	-	39-6A014**	-	39-6A014**	-	39-9A014**	39-2A014**
Ground Ring (Not Shown)	-	-	-	39-6A523	-	39-6A523	-	39-9A523P	39-2A523
8 = HP Gasket and Ring	31-1A677	31-3A677	39-6A677	39-6A677	39-6A677	39-6A677	-	39-9A677	39-2A677

\* Voltage and phasing positions must be specified (5th, 6th & 7th digit of Part #) to duplicate your shutter and alignment notches.

\*\* For appropriate labeling on a device, please specify voltage, phasing, and product type

\*\*\*For interiors with pilot contacts, contact Customer Service for part numbers.

# Spare Parts Female Configuration

DS

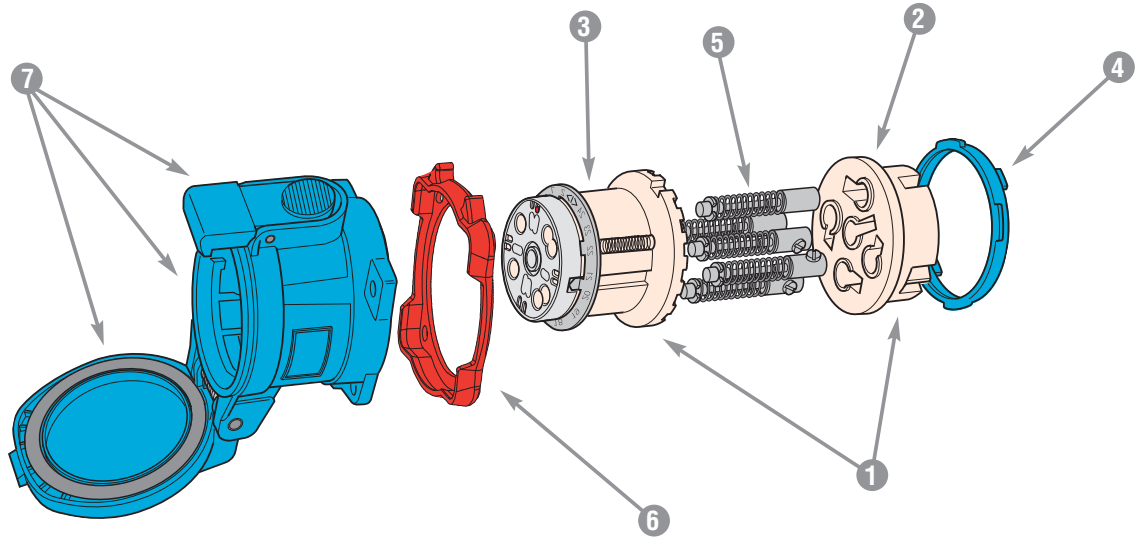

	DS20 POLY	DS30 POLY	DS60 POLY	DS60 METAL	DS100C POLY	DS100C METAL	DS100 POLY	DS100 METAL	DS200 METAL	
① = Receptacle Interior***	31-1A020*	31-3A020*	31-6A020*	31-6A020*	31-6A020-C*	31-6A020-C*	31-9A020*	39-9A020*	39-2A020*	
① = Receptacle Interior with Ground Contacts	-	-	-	39-6A220*	-	39-6A220-C*	-	39-9A220*	39-2A220*	
② = Interior Bottom	31-1A020-B	31-3A020-B	31-6A020-B	31-6A020-B	31-6A020-C-B	31-6A020-C-B	31-9A020-B	39-9A020-B	39-2A020-B	
③ = Interior Top	31-1A020-T*	31-3A020-T*	31-6A020-T*	31-6A020-T*	31-6A020-C-T*	31-6A020-C-T*	31-9A020-T*	39-9A020-T*	39-2A020-T*	
④ = Polyester Locking Ring	31-1A583	31-3A583	31-6A583	-	31-6A583	-	31-9A583	-	-	
④ = Metal Locking Ring	-	-	-	39-6A583	-	39-6A583	-	39-9A583	39-2A583	
⑤ = Receptacle Contact	31-1A021	31-3A021-380	31-6A021	31-6A021	31-6A021-C	31-6A021-C	39-9A021	39-9A021	39-2A021	
⑥ = Color-Coded Voltage Gasket	<div style="display: flex; flex-direction: column; gap: 5px;"> <div style="background-color: #0070C0; color: white; border-radius: 5px; padding: 2px 5px;">208V</div> <div style="background-color: #FF9900; color: white; border-radius: 5px; padding: 2px 5px;">250V</div> <div style="background-color: #FF0000; color: white; border-radius: 5px; padding: 2px 5px;">480V</div> <div style="background-color: #000000; color: white; border-radius: 5px; padding: 2px 5px;">600V</div> <div style="background-color: #FF9900; color: white; border-radius: 5px; padding: 2px 5px;">125V</div> </div>	31-1AB26	31-3AB26	31-6AB26	31-6AB26	31-6AB26	31-6AB26	31-9AB26	31-9AB26	39-2AB26
		31-3AC26	31-6AC26	31-6AC26	31-6AC26	31-6AC26	31-9AC26	31-9AC26	39-2AC26	
		31-3AR26	31-6AR26	31-6AR26	31-6AR26	31-6AR26	31-9AR26	31-9AR26	39-2AR26	
		31-3AN26	31-6AN26	31-6AN26	31-6AN26	31-6AN26	31-9AN26	31-9AN26	39-2AN26	
		31-1AC26	31-6AC26	31-6AC26	31-6AC26	31-6AC26	31-9AC26	31-9AC26	39-2AC26	
⑦ = Receptacle Polyester Casing with Lid	31-1A024**	31-3A024**	31-6A024**	-	31-6A024**	-	31-9A024**	-	-	
⑦ = Receptacle Metal Casing with Lid	-	-	-	39-6A024**	-	39-6A024**	-	39-9A024**	39-2A024**	
Ground Ring (Not Shown)	-	-	-	39-6A523	-	39-6A523	-	39-9A523	39-2A523	

\* Voltage and phasing positions must be specified (5th, 6th & 7th digit of Part #) to duplicate your shutter and alignment notches.

\*\* For appropriate labeling on a device, please specify voltage, phasing, and product type.

\*\*\*For interiors with pilot contacts, contact Customer Service for part numbers.

For replacement parts contact customer service at 800.433.7642

Courtesy of Gross Automation 1724 South Johnson Road New Berlin, WI PH: 262-446-0000 FAX: 262-446-0300 www.meltricsales.com





# Dimensions

## Inlet – Provided in inches and millimeters

Dimensions are for reference only

### Plug

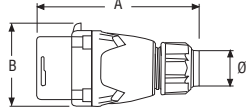

PRODUCT	A	B	Ø
	5.67	2.76	.32-.90
DS20/DS24	144	70	8-23
	5.83	3.23	.32-1.25
DS30/DS37	148	82	8-32
	6.89	3.86	.55-1.53
DS60/DS100C/DS7	175	98	14-39
	7.68	4.92	1.00-1.75
DS100	195	125	25-45
	10.24	5.55	1.50-2.25
DS200	260	141	40-58

### Inlet with connector on/off

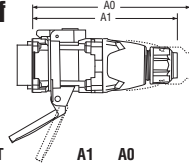

PRODUCT	A1	A0
	6.54	7.17
DS20/DS24	166	182
	6.85	7.48
DS30/DS37	174	190
	7.76	8.70
DS60/DS100C/DS7	197	221
	9.69	10.83
DS100	246	275
	12.20	13.43
DS200	310	341

### Inlet

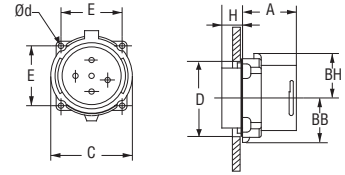

PRODUCT	A	BB	BH	C	D	E	H	Ød
	1.89	1.28	1.46	2.62	2.28	1.89	0.55	0.20
DS20/DS24	48	32.5	37	66.5	58	48.1	14	5.0
	2.05	1.48	1.75	3.07	2.76	2.17	0.71	0.20
DS30/DS37	52	37.5	44.5	78	70	55.1	18	5
	2.20	1.77	2.09	3.62	3.15	2.59	1.06	0.22
DS60/DS100C/DS7	56	45	53	92	80	65.8	27	5.5
	2.80	2.40	2.52	4.45	3.94	3.20	1.02	0.24
DS100	71	61	64	113	100	81.3	26	6
	3.11	2.87	2.68	5.12	4.65	3.86	1.57	0.26
DS200	79.0	73	68	130	118	98	40	6.5

### 30° inclined inlet/angle with connector on/off

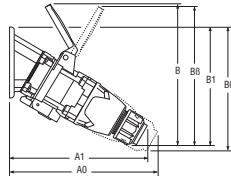

PRODUCT	A1	A0	B	B1	B0	BB
	7.56	8.11	7.24	6.69	7.01	7.83
DS20/DS24	192	206	184	170	178	199
	7.99	8.54	8.46	7.01	7.32	8.46
DS30/DS37	203	217	215	178	189	215
	9.02	9.84	9.76	8.35	8.82	10.00
DS60/DS100C/DS7	229	250	248	212	224	254
	11.89	12.87	12.24	9.53	10.12	
DS100	302	327	311	242	257	
	11.50	12.13	16.81	13.66	14.72	
DS200 60°	292	308	427	347	374	

### 30° inlet/conduit box

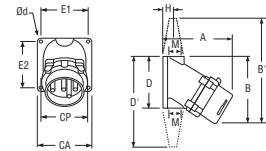

PRODUCT	A	B	CA	CP	D	E1	E2	H	PG	Ød
	4.37	4.13	3.31	2.64	3.31	2.76	2.76	0.69	0.50	0.24
DS20/DS24	111	105	84	67	84	70	70	17.5		6
	5.08	4.96	3.50	2.60	3.94	3.03	3.46	0.94	0.75	0.26
DS30/DS37	129	126	89	66	100	77	88	24		6.5
	6.69	6.22	4.13	3.62	5.04	3.50	4.41	1.22	1.25	0.30
DS60/DS100C/DS7 poly	170	158	105	92	128	89	112	31		7.5

### 30° inclined inlet/angle/junction box with connector on/off

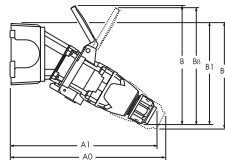

PRODUCT	A1	A0	B	B1	B0	BB
	10.04	10.59	7.24	6.81	7.13	7.83
DS20/DS24	255	269	184	173	181	199
	10.59	11.02	8.46	7.13	7.44	8.46
DS30/DS37	269	280	215	181	189	215
	12.09	12.91	9.76	8.54	9.02	10.00
DS60/DS100C/DS7	307	328	248	217	229	254
	15.51	16.50	12.24	9.53	10.12	
DS100	394	419	311	242	257	
	15.67	16.30	16.81	13.66	14.72	
DS200 60°	398	414	427	347	374	

### 30° inlet/angle

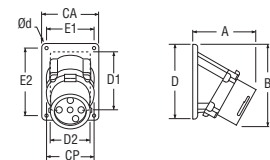

PRODUCT	A	B	CA	CP	D	D1	D2	E1	E2	Ød
	3.62	4.49	2.99	2.64	4.21	2.56	2.44	2.48	3.74	0.22
DS20/DS24	92	114	76	67	107	65	62	63	95	5.5
	3.94	4.72	2.99	2.60	4.21	2.56	2.68	2.48	3.74	0.22
DS30/DS37	100	120	76	66	107	65	68	63	95	5.5
	4.29	5.75	4.02	3.62	5.35	4.372	3.54	3.44	4.80	0.26
DS60/DS100C/DS7	109	146	102	92	136	111	90	87.3	122	6.5
	6.02	6.26	5.51	4.45	5.59	4.33	3.94	4.87	4.87	0.28
DS100	153	159	140	113	142	110	100	123.8	123.8	7.0
	6.93	8.90	7.20	5.12	7.20	5.91	5.91	6.50	6.50	0.28
DS200 60°	176	226	183	130	183	150	150	165	165	7.0

### 30° inclined inlet/conduit box with connector on/off

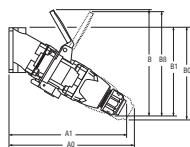

PRODUCT	A1	A0	B	B1	B0	BB
	8.31	8.86	7.24	6.34	6.65	7.83
DS20/DS24	211	225	184	161	169	199
	9.13	9.69	8.46	7.24	7.56	8.46
DS30/DS37	232	246	215	184	192	215
	11.14	11.97	9.76	8.66	9.13	10.00
DS60/DS100C/DS7 poly	283	304	248	220	232	254

### inlet/angle/metal junction box

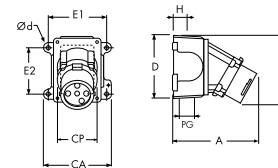

PRODUCT	A	B	CA	CP	D	E1	E2	H	PG	Ød
	6.10	4.61	4.40	2.64	4.57	3.75	2.78	1.18	1.00	0.25
DS20/DS24	155	117	111.8	67	116	95.3	70.6	30		6.4
	6.42	4.84	4.40	2.60	4.57	3.75	2.78	1.18	1.00	0.25
DS30/DS37	163	123	111.8	66	116	95.3	70.6	30		6.4
	7.36	5.94	5.75	3.62	5.81	5.00	3.82	1.57	1.50	0.30
DS60/DS100C/DS7	187	151	146	92	147.5	127	97	40		7.5
	9.65	6.26	7.54	4.45	5.65	6.62	4.24	1.93	2.00	0.31
DS100	245	159	191.5	113	143.5	168.1	107.7	49		7.8
	11.10	8.90	8.94	5.12	7.32	8.25	6.38	2.05	2.50	0.33
DS200 60°	282	226	227	130	186	209.6	162	52		8.4



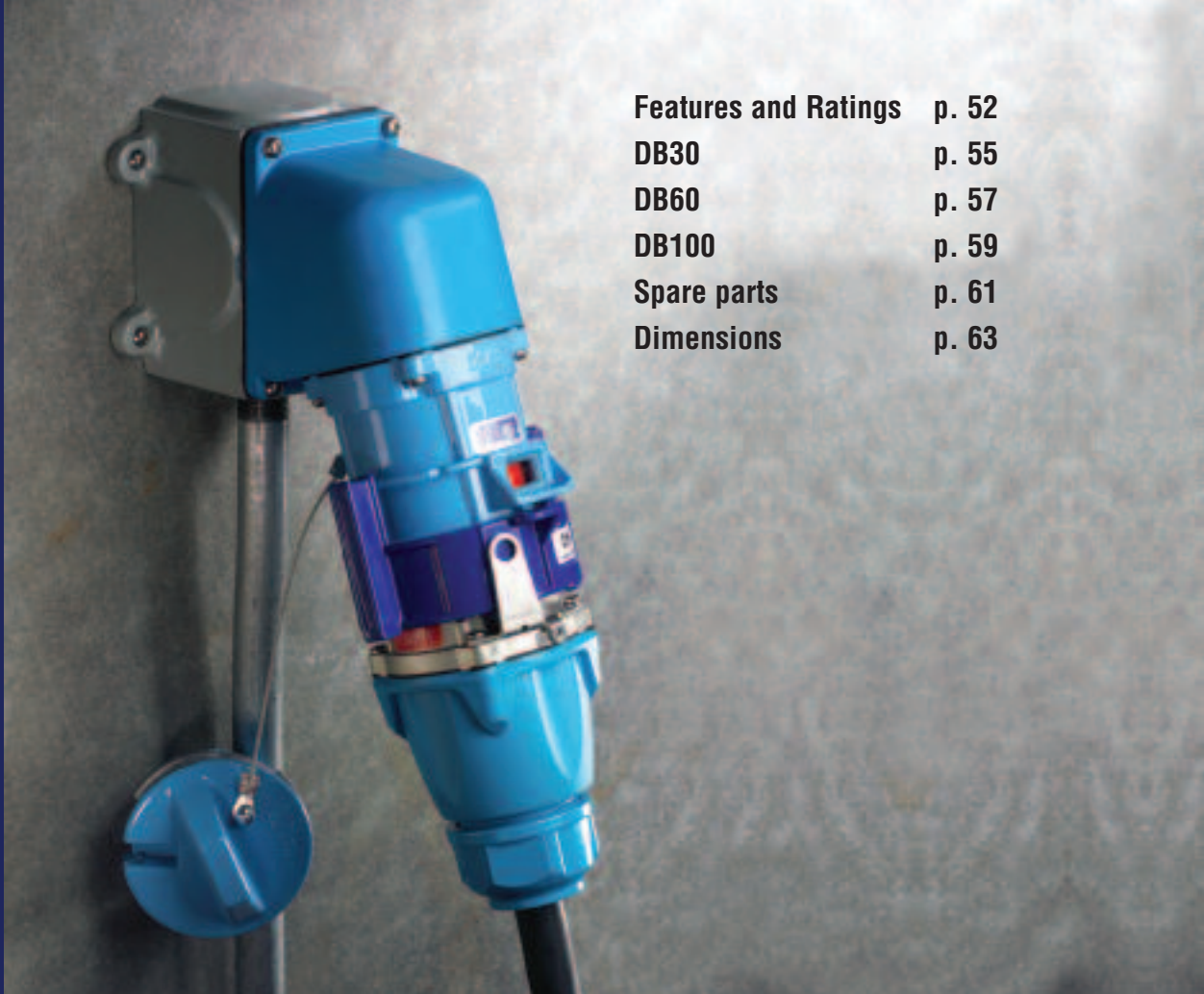

Features and Ratings	p. 52
DB30	p. 55
DB60	p. 57
DB100	p. 59
Spare parts	p. 61
Dimensions	p. 63



## Switch rated plugs and receptacles

DB's are the most rugged and highest horsepower rated plugs and receptacles in the DECONTACTOR™ Series product family. They are specifically designed for use on motors and other inductive loads. With their unique internal spring operating mechanism, two stage contact system, arc splitting feature and silver-nickel butt contacts, DB's can easily handle high horsepower inductive loads up to 60 hp.

### Main Advantages

- ▼ Switch & Hp rated
- ▼ 100 kA short circuit rated\*
- ▼ IP67 environmental ratings
- ▼ Up to 4 auxiliary contacts
- ▼ Durable metal construction.

### Highlighted Advantage

Simplify NFPA 70E Compliance

See pgs 17-18 for more information



\* See note under General Ratings on the next page

# Product Features

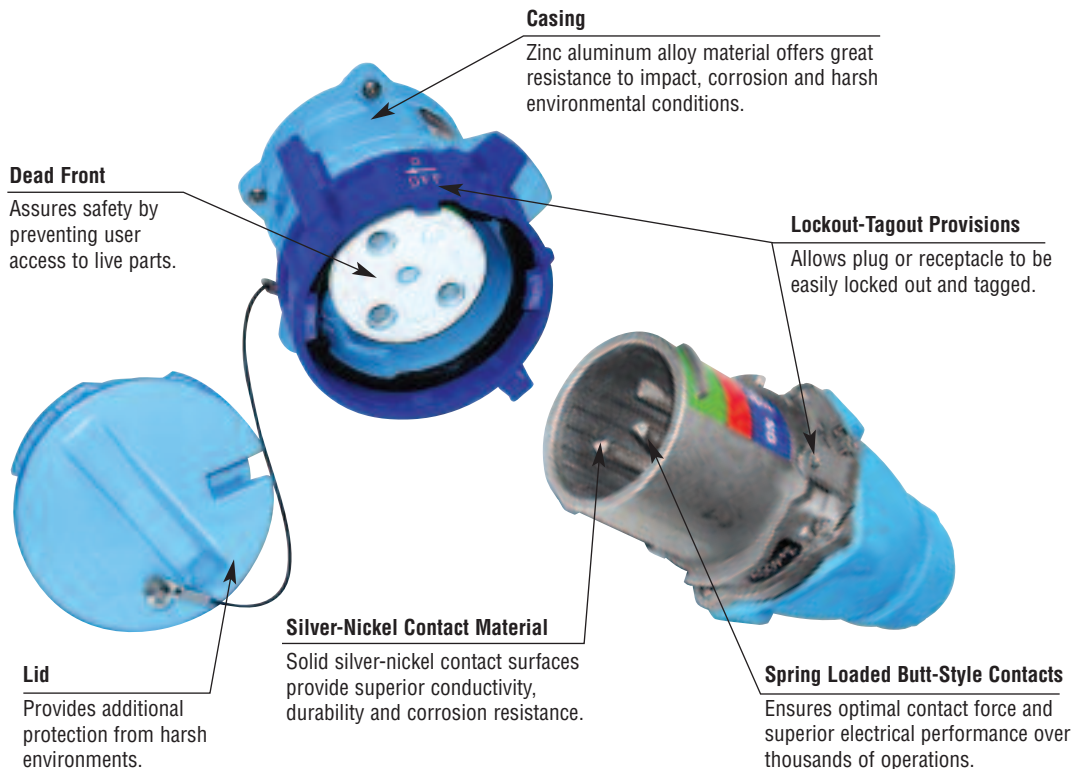

## General Ratings

<b>Amperage</b>	30 to 100A
<b>Voltage</b>	600 VAC, 250 VDC Max
<b>Frequency</b>	50-400 Hz
<b>Horsepower</b>	1 1/2 to 60 hp
<b>Short-Circuit (Make &amp; Withstand)</b>	100kA*
<b>Environmental</b>	IP67
<b>Temperature</b>	min -40°F/max 140°F

\* Testing was performed with RK1 current limiting fuses sized at 400% of the highest full load motor ampacity associated with the devices horsepower ratings, except for the DB100, which was tested with 250A fuses.

## Listings

Category	UL	CSA	IEC
Plugs and Receptacles	UL 1682	C22.2 No. 182.1	60309-1
Branch Circuit Disconnect Switching (AC only)	UL Subject 2682 (Performance tested to UL 98)	UL Subject 2682	60947-3, AC22, AC23
Motor Circuit Disconnect Switching (AC only)	UL Subject 2682 (Performance tested to UL 508)	UL Subject 2682	

CE ratings available upon request

Courtesy of Gross Automation 1724 South Johnson Road New Berlin, WI PH: 262-446-0000 FAX: 262-446-0300 www.meltricsales.com

## Operating Instructions

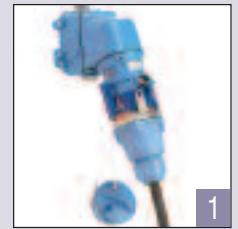

When the plug and receptacle are latched together, the circuit is connected.



Turning the receptacle ring counterclockwise releases the plug and rapidly opens the circuit. The plug is ejected to its rest position.

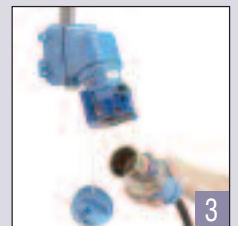

From the rest position the 'dead' plug can be withdrawn by rotating it counterclockwise. The receptacle can be made watertight up to IP67 by replacing the lid and turning the locking ring fully clockwise.



To reconnect, insert plug and twist. Pushing the plug fully home safely makes the circuit. The plug is held in the 'on' position by a locking ring. IP 67 protection is enabled by fully rotating the locking ring in the clockwise direction.

## Highlighted Feature

### Typical Device Labels

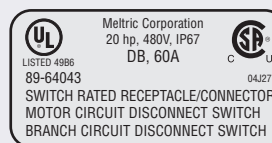

DB Deconnectors are UL & CSA rated for "motor circuit" and "branch circuit" disconnect switching – up to 60 hp and up to 100A

# Product Features

## Spring Loaded Operating Mechanism

DB Series Decontactors use an internal spring-loaded operating mechanism to open and close the contacts at high speed, independent of the manual motion of the user.

### Load-Making

- 

1. As the plug is first inserted into the receptacle, the contact travels toward the operating mechanism. Only the receptacle contact (shown at the top of the drawing) is live.
- 

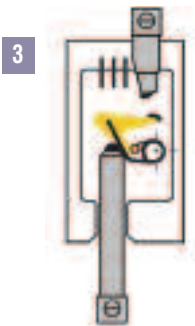
2. As the plug contact is inserted further, it engages a mobile intermediate contact on the operating mechanism, which it begins to move around a stop. This motion also begins to wind the operating spring.
- 

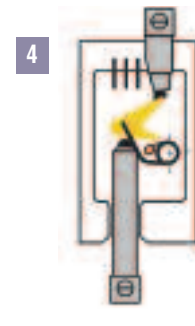
3. As the plug is inserted further, to the almost completely engaged position, the operating spring becomes fully loaded and the mobile contact rotates into a position where any further insertion motion will release it from the stop.
- 

4. As the last small insertion motion is made, the mobile contact clears the stop and releases the energy in the spring. This instantly drives the mobile contact into engagement with the receptacle contact and completes the electrical connection.

### Load-Breaking

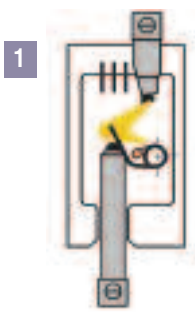
- 

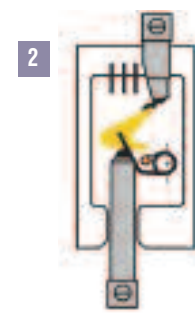
1. When the contacts are engaged, the operating spring is still almost fully charged. This maintains contact pressure and provides energy for the breaking operation.
- 

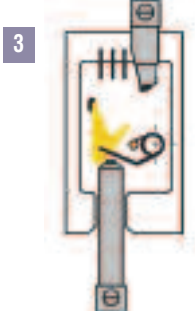
2. In order to break the circuit, the plug retaining ring is turned to the 'off' position. This releases the plug, which in turn releases the mobile contact and the spring energy in the operating mechanism.
- 

3. The spring energy instantly drives the mobile contact away from the live receptacle contact. It follows a different path than on making and is moved along an arc chute.
- 

4. The mobile contact returns to its initial position, preparing the device to be used again.

## Two Stage Contact System

The operation of the DB's contacts was specifically designed to ensure that load-breaking and load-carrying are performed in separate locations on the contacts.

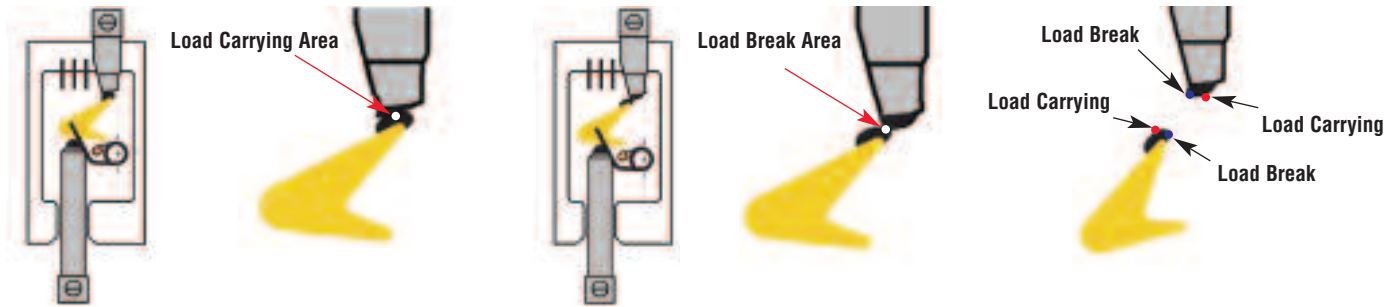

This is accomplished with the motion of the mobile contact relative to the receptacle contact. The opening of the contacts begins with a wiping action that moves the contact area toward the edges of the contacts, where load-breaking occurs. This allows numerous overload-breaking operations without deteriorating the main contact surfaces or the continuity of the connection.

## Arc-Extinguishing System

For higher currents, or when significant overloads are involved, additional provision is desirable to handle the arcing that occurs during load-breaking. Meltric accomplishes this on its DB Series Decontactors with a series of magnetic V-shaped blades, which create an arc chute.

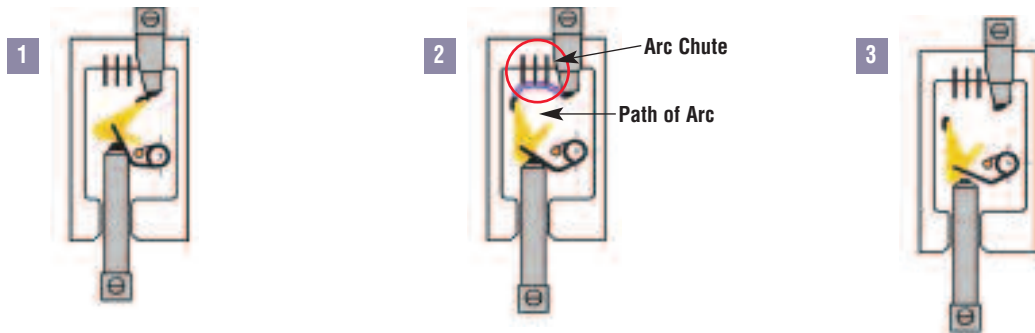

As the contacts open, the mobile intermediate contact moves along the arc chute. The arc is transferred to the magnetic "V" shaped blades, which splits and destabilizes it. This helps to cool and quickly extinguish the arc, minimizing any potential damage to the contacts. Together with the spring operator, two stage contact system and silver-nickel butt style contacts, this feature allows the DB series to easily and safely break high horsepower inductive loads and significant overloads.



# DECONTACTOR™ – 30A

## Switch Rated Plugs & Receptacles

### Ratings

- Voltage**  
600 VAC, 250 VDC
- Switch Ratings (AC)**  
Branch Circuit & Motor Circuit Disconnect Switching
- Horsepower ratings**
  - 120V 1Ø 1 1/2 hp
  - 240V 1Ø 3 hp
  - 208V 3Ø 7 1/2 hp
  - 240V 3Ø 7 1/2 hp
  - 480V 3Ø 10 hp
  - 600V 3Ø 10 hp
- Short Circuit Rating**  
100kA Close & Withstand  
Testing was performed with RK1 current limiting fuses sized at 400% of the highest full load motor ampacity associated with the devices hp rating.
- Environmental Ratings**  
IP67
- Temperature Range**  
Min -40°F/Max 140°F  
See pg 194 for temps below -15°F.
- Wiring Capacity**  
Min 14 AWG Max 8 AWG  
Aux Contacts - Max 14 AWG
- Listings**  
UL, CSA, IEC, CE\*  
\* Contact Customer Service

### Receptacle (female)



*Don't forget to add installation accessories to your order*

### Inlet (male)



Voltage	Polarity	Part # Metal
120/208V	3P+N+E	89-34167
125V	1P+N+E	89-34075
125/250V	2P+N+E	89-34076
208V	2P+E	89-34162
208V	3P+E	89-34163
250V	2P+E	89-34072
250V	3P+E	89-34073
277V	1P+N+E	89-34045
277/480V	3P+N+E	89-34047
347/600V	3P+N+E	89-34147
480V	2P+E	89-34042
480V	3P+E	89-34043
600V	2P+E	89-34142
600V	3P+E	89-34143

Voltage	Polarity	Part # Metal
120/208V	3P+N+E	89-38167
125V	1P+N+E	89-38075
125/250V	2P+N+E	89-38076
208V	2P+E	89-38162
208V	3P+E	89-38163
250V	2P+E	89-38072
250V	3P+E	89-38073
277V	1P+N+E	89-38045
277/480V	3P+N+E	89-38047
347/600V	3P+N+E	89-38147
480V	2P+E	89-38042
480V	3P+E	89-38043
600V	2P+E	89-38142
600V	3P+E	89-38143

Other voltage configurations are available – contact customer service at 800.433.7642.

### Main Options



Auxiliary/Pilot Contacts

### Receptacle Options

### Suffix #

With 2 Auxiliary/Pilot Contacts Recept # - 172\*

### Inlet Options

### Suffix #

With 2 Auxiliary/Pilot Contacts Inlet # - 172\*

\* Auxiliary/Pilot Contacts are not available on DB devices with 1P+N+E, 2P+N+E or 3P+N+E polarity

See pgs 171-180 for detailed information on these options

**DB30 Order Example:**  
To order 2 auxiliary/pilot contacts on an inlet and receptacle add -172 to the part numbers.  
DB30 Metal inlet 3P+E=89-38043-172  
DB30 Metal receptacle 3P+E=89-34043-172  
Appropriate accessory part numbers must also be included on the order.

# Installation Accessories

## Handles

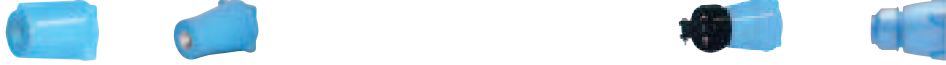

NPT	Poly Handle	Metal* Handle
1/2"	3PH12	3H12
3/4"	3PH34	3H34
1"	3PH1	3H1
1 1/4"	3PH114	3H114
1 1/2"	-	3H112

Cable Range	Poly Handle w/Clamp & Bushing	Nylon Handle
.39 - 1.18	-	FH311
.750 - .875	3PM514	-
.875 - 1.000	3PM516	-
1.000 - 1.125	3PM518	-
1.125 - 1.250	3PM520	-
1.250 - 1.375	3PM522	-

## Angles



Metal 30° Angle	Metal 70° Angle	Metal Angle FS/FD Box 30°	Metal Straight Adapter
MA3	89-3A027	MAFS3	MS3

## NPT Guidelines

Cable Range	NPT
.062 - .5	1/2"
.187 - .75	3/4"
.437 - 1.10	1"
.750 - 1.375	1 1/4"

NPT sizes are determined by the cable diameter and third party cord grip.

## Junction Boxes



NPT	Metal Box	Metal Box with Metal Angle
1/2"	MB312	89-3A053-080-12
3/4"	MB334	89-3A053-080-34
1"	MB31	89-3A053-080-1
1 1/4"	MB3114	89-3A053-080-114

## Miscellaneous Accessories



For Male Devices Only



Protective Cap	Cord Grip with Mesh
89-3A126	see pgs 167-168

## Order Example

A typical order should include an inlet part number, a receptacle part number **AND** the matching handles, angles or other required accessories.



Male Inlet with Handle (Plug)  
89-38075 + FH311



Female Receptacle with Angle Adapter  
89-34075 + 89-3A027





# DECONTACTOR™ – 60A

## Switch Rated Plugs & Receptacles

### Ratings

- Voltage**  
600 VAC, 250 VDC
- Switch Ratings (AC)**  
Branch Circuit & Motor Circuit Disconnect Switching
- Horsepower ratings**
  - 120V 1Ø 3 hp
  - 240V 1Ø 7 1/2 hp
  - 208V 3Ø 15 hp
  - 240V 3Ø 15 hp
  - 480V 3Ø 30 hp
  - 600V 3Ø 30 hp
- Short Circuit Rating**  
100kA Close & Withstand  
Testing was performed with RK1 current limiting fuses sized at 400% of the highest full load motor ampacity associated with the devices hp rating.
- Environmental Ratings**  
IP67
- Temperature Range**  
Min -40°F/Max 140°F  
See pg 194 for temps below -15°F.
- Wiring Capacity**  
Min 8 AWG Max 3 AWG  
Aux Contacts - Max 14 AWG
- Listings**  
UL, CSA, IEC, CE\*  
\* Contact Customer Service

### Receptacle (female)



*Don't forget to add installation accessories to your order*

### Inlet (male)



Voltage	Polarity	Part # Metal
120/208V	3P+N+E	89-64167
125V	1P+N+E	89-64075
125/250V	2P+N+E	89-64076
208V	2P+E	89-64162
208V	3P+E	89-64163
250V	2P+E	89-64072
250V	3P+E	89-64073
277V	1P+N+E	89-64045
277/480V	3P+N+E	89-64047
347/600V	3P+N+E	89-64147
480V	2P+E	89-64042
480V	3P+E	89-64043
600V	2P+E	89-64142
600V	3P+E	89-64143

Voltage	Polarity	Part # Metal
120/208V	3P+N+E	89-68167
125V	1P+N+E	89-68075
125/250V	2P+N+E	89-68076
208V	2P+E	89-68162
208V	3P+E	89-68163
250V	2P+E	89-68072
250V	3P+E	89-68073
277V	1P+N+E	89-68045
277/480V	3P+N+E	89-68047
347/600V	3P+N+E	89-68147
480V	2P+E	89-68042
480V	3P+E	89-68043
600V	2P+E	89-68142
600V	3P+E	89-68143

Other voltage configurations are available – contact customer service at 800.433.7642.

### Main Options



Auxiliary/Pilot Contacts

### Receptacle Options

### Suffix #

With 2 Auxiliary/Pilot Contacts Recept # - 172\*

### Inlet Options

### Suffix #

With 2 Auxiliary/Pilot Contacts Inlet # - 172\*

\* Auxiliary/Pilot Contacts are not available on DB devices with 1P+N+E, 2P+N+E or 3P+N+E polarity

See pgs 171-180 for detailed information on these options

#### DB60 Order Example:

To order 2 auxiliary/pilot contacts on an inlet and receptacle add -172 to the part numbers.

DB60 Metal inlet 3P+E=89-68043-172

DB60 Metal receptacle 3P+E=89-64043-172

Appropriate accessory part numbers must also be included on the order.

# Installation Accessories

## Handles



NPT	Poly Handle	Metal* Handle	Cable Range	Poly Handle w/Clamp & Bushing	Nylon Handle
1/2"	6PH12	6H12	.51 - 1.38	–	FH611
3/4"	6PH34	6H34	1.250 - 1.375	6PM622	–
1"	6PH1	6H1	1.438 - 1.562	6PM625	–
1 1/4"	6PH114	6H114	1.562 - 1.688	6PM627	–
1 1/2"	6PH112	6H112	1.688 - 1.812	6PM629	–

## Angles



Metal 30° Angle	Metal 70° Angle	Metal Angle Oversized 30°	Metal Straight Adapter	Metal Lateral Angle 30°
MA6	89-6A027	MA660	MS6	MAB6

## NPT Guidelines

Cable Range	NPT
.062 - .5	1/2"
.187 - .75	3/4"
.437 - 1.10	1"
.750 - 1.375	1 1/4"
.890 - 1.650	1 1/2"

NPT sizes are determined by the cable diameter and third party cord grip.

## Junction Boxes



NPT	Metal Box	Metal Box with Metal Angle
1"	MB61	89-6A053-080-1
1 1/4"	MB6114	89-6A053-080-114
1 1/2"	MB6112	89-6A053-080-112
2"	MB62	89-6A053-080-2

## Miscellaneous Accessories



For Male Devices Only



Protective Cap	Cord Grip with Mesh
89-6A126	see pgs 167-168

## Order Example

A typical order should include an inlet part number, a receptacle part number **AND** the matching handles, angles or other required accessories.



Male Inlet with Handle (Plug)  
89-68043 + FH611



Female Receptacle with Angle Adapter  
89-64043 + 89-6A027

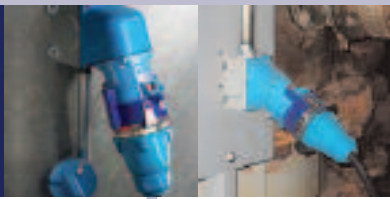

# DECONTACTOR™ – 100A

## Switch Rated Plugs & Receptacles

### Ratings

- Voltage**  
600 VAC, 250 VDC
- Switch Ratings (AC)**  
Branch Circuit & Motor Circuit Disconnect Switching
- Horsepower ratings**

120V	1Ø	7 1/2 hp
240V	1Ø	10 hp
208V	3Ø	30 hp
240V	3Ø	30 hp
480V	3Ø	60 hp
600V	3Ø	60 hp
- Short Circuit Rating**  
100kA Close & Withstand  
Testing was performed with 250A RK1 fuses, so the 100kA rating applies up to 60 hp @ 600, 40 hp @ 480V and 20 hp @ 240V and 208V.
- Environmental Ratings**  
IP67
- Temperature Range**  
Min -40°F/Max 140°F  
See pg 194 for temps below -15°F.
- Wiring Capacity**  
Min 1/0\* AWG Max 2/0 AWG  
Aux Contacts - Max 14 AWG  
Smaller conductors can be retained in the terminal, but may result in a temperature rise greater than the 30° max allowed in UL & CSA standards.
- Listings**  
UL, CSA, IEC, CE\*  
\* Contact Customer Service

### Receptacle (female)



### Inlet (male)



Voltage	Polarity	Part # Metal
120/208V	3P+N+E	89-94167
125V	1P+N+E	89-94075
125/250V	2P+N+E	89-94076
208V	2P+E	89-94162
208V	3P+E	89-94163
250V	2P+E	89-94072
250V	3P+E	89-94073
277V	1P+N+E	89-94045
277/480V	3P+N+E	89-94047
347/600V	3P+N+E	89-94147
480V	2P+E	89-94042
480V	3P+E	89-94043
600V	2P+E	89-94142
600V	3P+E	89-94143

Voltage	Polarity	Part # Metal
120/208V	3P+N+E	89-98167
125V	1P+N+E	89-98075
125/250V	2P+N+E	89-98076
208V	2P+E	89-98162
208V	3P+E	89-98163
250V	2P+E	89-98072
250V	3P+E	89-98073
277V	1P+N+E	89-98045
277/480V	3P+N+E	89-98047
347/600V	3P+N+E	89-98147
480V	2P+E	89-98042
480V	3P+E	89-98043
600V	2P+E	89-98142
600V	3P+E	89-98143

Other voltage configurations are available – contact customer service at 800.433.7642.

### Main Options



Auxiliary/Pilot Contacts

### Receptacle Options

### Suffix #

With 4 Auxiliary/Pilot Contacts    Recept # - 174\*\*

### Inlet Options

### Suffix #

With 4 Auxiliary/Pilot Contacts    Inlet # - 174\*\*

\* DB100 devices with auxiliary/pilot contacts are not UL/CSA listed

\*\* Auxiliary/Pilot Contacts are not available on DB devices with 1P+N+E, 2P+N+E or 3P+N+E polarity



See pgs 171-180 for detailed information on these options

#### DB100 Order Example:

To order 4 auxiliary/pilot contacts on an inlet and receptacle add **-174** to the part numbers.

DB100 Metal inlet 3P+E=89-98043-**174**

DB100 Metal receptacle 3P+E=89-94043-**174**

Appropriate accessory part numbers must also be included on the order.

# Installation Accessories

## Handles



NPT	Poly Handle	Metal* Handle
3/4"	9PH34	9H34
1"	9PH1	9H1
1 1/4"	9PH114	9H114
1 1/2"	9PH112	9H112
2"	9PH2	9H2

Cable Range	Poly Handle w/Clamp & Bushing
1.25 - 1.375	9PM622
1.438 - 1.562	9PM625
1.562 - 1.688	9PM627
1.688 - 1.812	9PM629

## Angles



Metal 30° Angle	Metal 70° Angle	Metal Angle Oversized 30°	Metal Straight Adapter
MA10	89-9A027	MA110	MS10

## NPT Guidelines

Cable Range	NPT
.187 - .75	3/4"
.437 - 1.10	1"
.750 - 1.375	1 1/4"
.890 - 1.650	1 1/2"
1.125 - 2.438	2"

NPT sizes are determined by the cable diameter and third party cord grip.

## Junction Boxes



NPT	Metal Box	Metal Box with Metal Angle
1 1/4"	MB10114	89-9A053-080-114
1 1/2"	MB10112	89-9A053-080-112
2"	MB102	89-9A053-080-2

## Miscellaneous Accessories



For Male Devices Only



Protective Cap	Cord Grip with Mesh
89-9A126	see pgs 167-168

## Order Example

A typical order should include an inlet part number, a receptacle part number **AND** the matching handles, angles or other required accessories.



Male Inlet with Handle (Plug)  
89-98043 + 9PM622



Female Receptacle with Angle Adapter  
89-94043 + 89-9A027



## Spare Parts Male Configuration

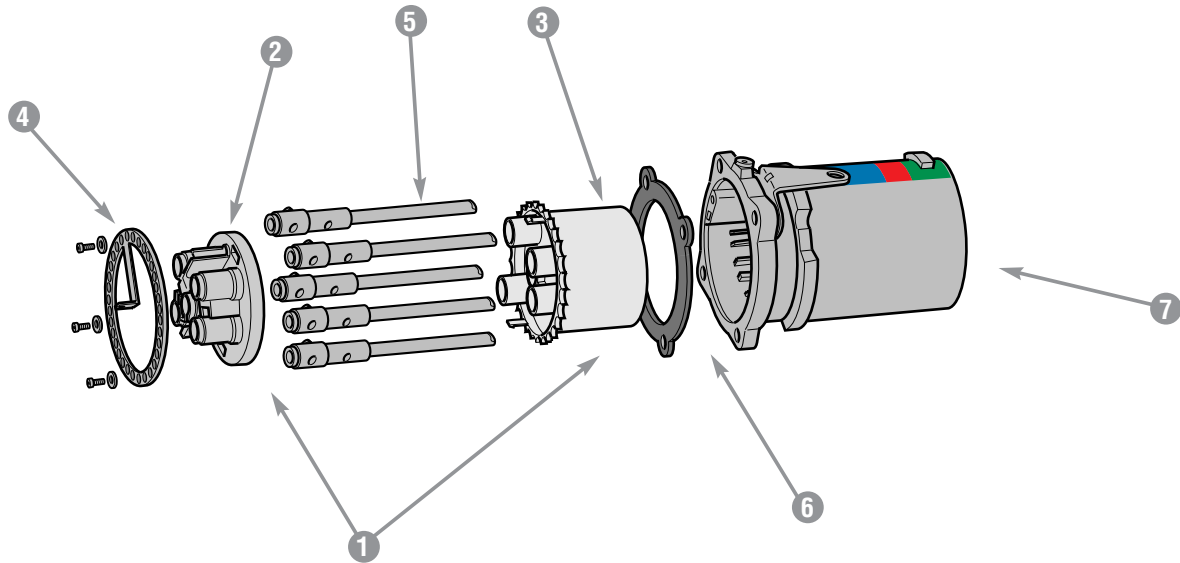

	DB30 METAL	DB60 METAL	DB100 METAL
① = Plug Interior with Pilot Contact Assembly	89-3A010-172*	89-6A010-172*	89-9A010-174*
① = Plug Interior without Pilot Contact Assembly	89-3A010*	89-6A010*	89-9A010*
② = Interior Bottom	89-3A010-B	89-6A010-B	89-9A010-B
③ = Interior Top for Pilot Contact Assembly	89-3A010-T-172*	89-6A010-T-172*	89-9A010-T-174*
③ = Interior Top without Pilot Contact Assembly Holes	89-3A010-T*	89-6A010-T*	89-9A010-T*
④ = Metal Locking Ring/Ground Ring	89-3A523	89-6A523	89-9A523
⑤ = Ground Contact	89-3A019	89-6A019	89-9A019
⑤ = Phase or Neutral Contact	89-3A011	89-6A011	89-9A011
⑤ = Pilot (2 Contacts) Assembly	89-3A219-172	89-6A219-172	-
⑤ = Pilot (4 Contacts) Assembly	-	-	89-9A219-174
⑥ = Device Gasket	89-3A026	89-6A026	89-9A026
⑦ = Plug Metal Casing	89-3A014**	89-6A014**	89-9A014**

\* Voltage and phasing positions must be specified (5th, 6th & 7th digit of Part #) to duplicate your shutter and alignment notches.

\*\* For appropriate labeling on a device, please specify voltage, phasing, and product type.

# Spare Parts

## Female Configuration

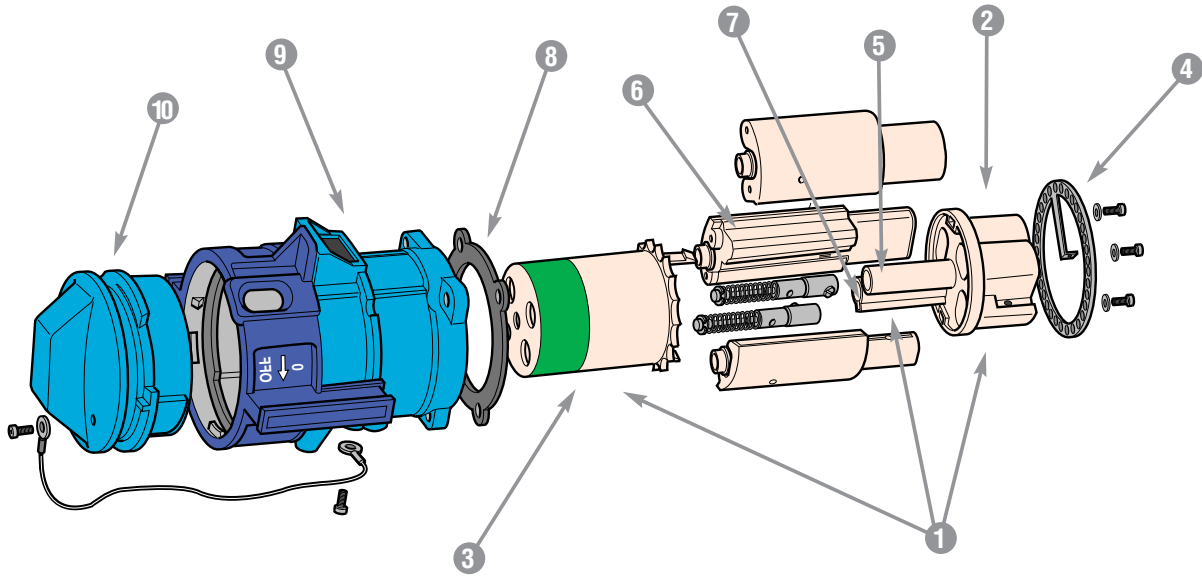

	DB30 METAL	DB60 METAL	DB100 METAL
① = Receptacle Interior with Pilot Contact Assembly	89-3A020-172*	89-6A020-172*	89-9A020-174*
① = Receptacle Interior without Pilot Contact Assembly	89-3A020*	89-6A020*	89-9A020*
② = Interior Bottom	89-3A020-B	89-6A020-B	89-9A020-B
③ = Interior Top for Pilot Contact Assembly	89-3A020-T-172*	89-6A020-T-172*	89-9A020-T-174*
③ = Interior Top without Pilot Contact Assembly Holes	89-3A020-T*	89-6A020-T*	89-9A020-T*
④ = Metal Locking Ring/Ground Ring	89-3A523	89-6A523	89-9A523
⑤ = Ground Contact	89-3A029	89-6A029	89-9A029
⑥ = Phase Contact	89-3A021	89-6A021	89-9A021
⑦ = Neutral Contact	89-3A021N	89-6A021N	89-9A021N
⑦ = Pilot (2 Contacts) Assembly	89-3A229-172	89-6A229-172	-
⑦ = Pilot (4 Contacts) Assembly	-	-	89-9A229-174
⑧ = Device Gasket	89-3A026	89-6A026	89-9A026
⑨ = Receptacle Metal Casing	89-3A024**	89-6A024**	89-9A024**
⑩ = Protective Cap with Nylon Cord	89-3A925**	89-6A925**	89-9A925**

\* Voltage and phasing positions must be specified (5th, 6th & 7th digit of Part #) to duplicate your shutter and alignment notches.

\*\* For appropriate labeling on a device, please specify voltage, phasing, and product type

For replacement parts contact customer service at 800.433.7642

Courtesy of Gross Automation 1724 South Johnson Road New Berlin, WI PH: 262-446-0000 FAX: 262-446-0300 www.meltricsales.com



# Dimensions

## Inlet – Provided in inches and millimeters

Dimensions are for reference only

### Plug

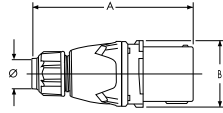

PRODUCT	A	B	Ø
	7.6	3.11	.32-1.25
DB30	193	79	8-32
	7.95	3.9	.55-1.53
DB60	202	99	14-39
	12.01	4.33	1.25-1.812
DB100	305	110	32-46

### Inlet

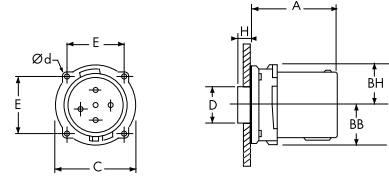

PRODUCT	A	BB	BH	C	D	E	H	Ød
	3.82	1.5	1.61	3.07	2.17	2.17	0.71	0.18
DB30	97	38	41	78	55	55.1	18	4.5
	3.9	1.77	2.13	3.58	2.68	2.59	0.83	0.22
DB60	99	45	54	91	68	65.8	21	5.5
	4.74	2.09	2.24	4.53	3.35	3.2	1.61	0.22
DB100	120.4	53	57	115	85	81.3	41	5.5

### 70° inclined inlet/angle with connector on/off

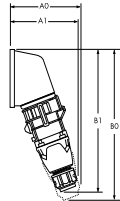

PRODUCT	A1	A0	B1	B0
	6.02	6.57	11.54	12.99
DB30	153	167	293	330
	6.85	7.36	13.46	14.88
DB60	174	187	342	378
	8.62	9.41	17.60	19.80
DB100	219	239	447	503

### 70° inlet/angle

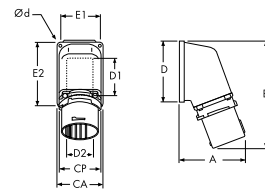

PRODUCT	A	B	CA	CP	D	D1	D2	E1	E2	Ød
	4.61	7.28	3.03	3.07	4.17	3.15	2.56	2.48	3.74	0.22
DB30	117	185	77	78	106	80	65	63	95	5.5
	5.35	8.74	4.02	3.58	5.35	4.53	3.15	3.44	4.8	0.26
DB60	136	222	102	91	136	115	80	87.3	122	6.5
	6.42	9.88	5.51	5.75	5.51	4.92	3.94	4.87	4.87	0.26
DB100	163	251	140	146	140	125	100	123.8	123.8	6.5

### 70° inclined inlet/angle/junction box with connector on/off

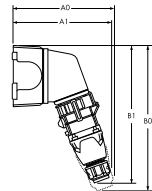

PRODUCT	A1	A0	B1	B0
	8.54	9.06	11.65	13.15
DB30	217	230	296	334
	9.96	10.47	13.66	15.08
DB60	253	266	347	383
	12.24	13.03	17.60	19.80
DB100	311	331	447	503

### inlet with connector on/off

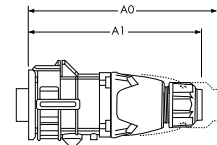

PRODUCT	A1	A0
	8.39	9.96
DB30	213	253
	9.02	10.51
DB60	229	267
	13.23	15.59
DB100	336	396

### 70° surface inlet/angle/ metal junction box

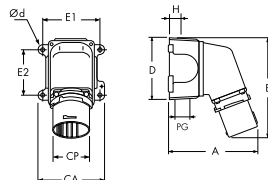

PRODUCT	A	B	CA	CP	D	E1	E2	H	PG	Ød
	7.09	7.4	4.33	3.07	4.61	3.70	2.78	1.18	0.83	0.25
DB30	180	188	110	78	117	94	70.6	30	21	6.4
	8.43	8.94	5.71	3.58	5.71	4.92	3.82	1.57	1.14	0.31
DB60	214	227	145	91	145	125	97	40	29	7.8
	10.04	9.88	7.48	5.75	5.51	6.69	4.24	1.93	1.42	0.31
DB100	255	251	190	146	140	170	107.7	49	36	7.8

# Dimensions

## Receptacle – Provided in inches and millimeters

Dimensions are for reference only

### connector

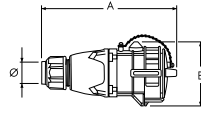

PRODUCT	A	B	Ø
	7.99	3.54	.32-1.25
DB30	203	90	8-32
	8.82	4.02	.55-1.53
DB60	224	102	14-39
	12.56	4.92	1.25-1.812
DB100	319	125	32-46

### receptacle

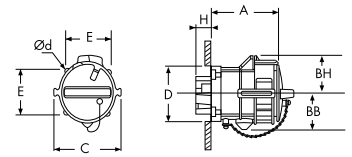

PRODUCT	A	BB	BH	C	D	E	H	Ød
	4.21	1.77	1.77	4.33	2.17	2.17	1.02	0.18
DB30	106.9	45	45	110	55	55.1	26	4.5
	4.75	2.01	2.01	4.88	2.68	2.59	1.26	0.22
DB60	120.7	51	51	124	68	65.8	32	5.5
	5.28	2.46	2.46	5.75	3.35	3.20	1.65	0.22
DB100	134.2	62.5	62.5	146	85	81.3	42	5.5

### 70° inclined receptacle/angle with plug on/off

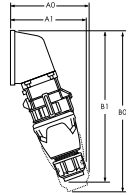

PRODUCT	A1	A0	B1	B0
	6.02	6.57	11.54	12.99
DB30	153	167	293	330
	6.85	7.36	13.46	14.88
DB60	174	187	342	378
	8.62	9.41	17.60	19.80
DB100	219	239	447	503

### 70° receptacle/angle

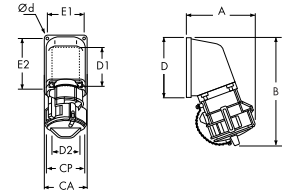

PRODUCT	A	B	CA	CP	D	D1	D2	E1	E2	Ød
	5.24	7.83	3.03	4.33	4.17	3.15	2.56	2.48	3.74	0.22
DB30	133	199	77	110	106	80	65	63	95	5.5
	6.10	9.72	4.02	4.88	5.35	4.53	3.15	3.44	4.80	0.26
DB60	155	247	102	124	136	115	80	87.3	122	6.5
	7.13	10.55	5.51	5.75	5.51	4.92	3.94	4.87	4.87	0.26
DB100	181	268	140	146	140	125	100	123.8	123.8	6.5

### 70° inclined receptacle/angle junction box with plug on/off

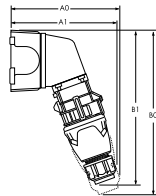

PRODUCT	A1	A0	B1	B0
	8.54	9.06	11.65	13.15
DB30	217	230	296	334
	9.96	10.47	13.66	15.08
DB60	253	266	347	383
	12.24	13.03	17.60	19.80
DB100	311	331	447	503

### receptacle with plug on/off

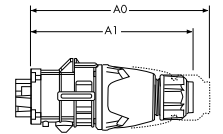

PRODUCT	A1	A0
	8.39	9.96
DB30	213	253
	9.02	10.51
DB60	229	267
	13.23	15.59
DB100	336	396

### 70° receptacle/angle metal junction box

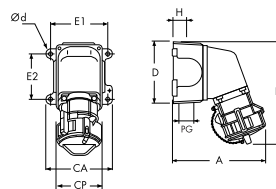

PRODUCT	A	B	CA	CP	D	E1	E2	H	PG	Ød
	7.72	7.95	3.31	4.33	4.61	3.70	2.78	1.18	0.83	0.25
DB30	196	202	84	110	117	94	70.6	30	21	6.4
	9.21	9.92	4.49	4.88	5.71	4.92	3.82	1.57	1.14	0.31
DB60	234	252	114	124	145	125	97	40	29	7.8
	10.75	10.55	5.51	5.75	5.51	6.69	4.24	1.93	1.42	0.31
DB100	273	268	140	146	140	170	107.7	49	36	7.8



# Hazardous Duty Plugs & Receptacles

## DXN and DX Series

DXN and DX Series plugs and receptacles are appropriately rated for most hazardous duty environments. When DXN and DX series devices are installed, users can safely connect or disconnect resistive loads such as lighting or mixed resistive and inductive loads, such as welders, under full load. Both DXN and DX devices can be used as in-line connectors as well as in traditional wall mounted receptacle applications.

Common industry applications:

- ▼ Chemical plants
- ▼ Pharmaceutical plants
- ▼ Oil and Gas facilities
- ▼ Grain silos
- ▼ Wood processing plants
- ▼ Plastics plants
- ▼ Wastewater plants



*"Inline" DXN Series  
plug and connector*



*DXN and DX Series plugs and receptacles are suitable for  
installations that may contain flammable gases, vapors or dusts.*



*"Wall Mounted" DX Series  
plug and receptacle*

# Selecting the Right Hazardous Duty Rated Plug & Receptacle

## Identify your area classification and relevant listings

Meltric offers two models of hazardous location plug and receptacles, the DXN series and the DX. Both are ATEX rated for use in Zone 1/21 and Zone 2/22 classified areas, and the DXN is additionally CSA Class I, Division 2 and Class II, Division 2 rated. Both are safe to make and break under full load in these areas (resistive loads or mixed resistive and inductive loads only).

Area Classification/Equipment Rating Requirement				
		North American		IEC
Explosive Atmosphere is continuously present	GAS	Class I, Division 1	Zone 0	ATEX II 1G
	DUST	Class II, Division 1	Zone 20	ATEX II 1D
Explosive atmosphere may occur in normal operation	GAS	Class I, Division 1	<b>Zone 1</b>	<b>ATEX II 2G</b>
	DUST	Class II, Division 1	<b>Zone 21</b>	<b>ATEX II 2D</b>
Explosive atmosphere may appear accidentally or in abnormal conditions	GAS	Class I, Division 2	Zone 2	ATEX II 3G
	DUST	Class II, Division 2	Zone 22	ATEX II 3D

## Choose between the DXN or DX to meet your hazardous duty plug and receptacle requirements:

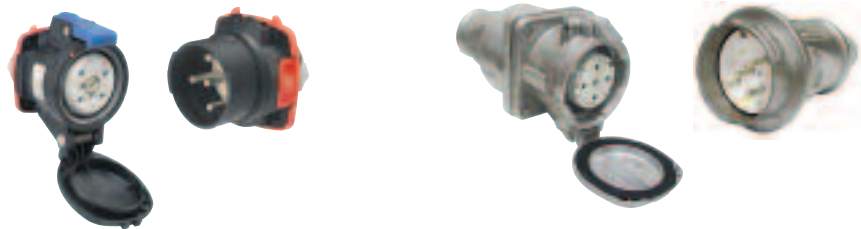

**DXN**

**DX**

<b>Construction</b>	Lightweight poly	Heavy duty aluminum
<b>Hazardous Use Rating</b>	Zone 1/21 and 2/22, Class I or II Div 2	Zone 1/21 and 2/22
<b>Ratings Agency</b>	ATEX and CSA	ATEX
<b>Amperage Range</b>	20 - 60A	20 - 100A
<b>Maximum Voltage</b>	600 VAC*	600 VAC
<b>Environmental Rating</b>	IP66 + 67	IP65
<b>Automatic Watertightness</b>	Yes	Yes
<b>Dead Front</b>	Yes	Yes

\* 480 VAC for 20A model



Features and Ratings	p. 67
Certifications and Testing	p. 69
Operation	p. 70
DXN20	p. 71
DXN30	p. 73
DXN60	p. 75
Dimensions	p. 77



## Hazardous duty rated plugs and receptacles

DXN Series plugs and receptacles are convenient, lightweight devices that are safe for use in hazardous environments such as refineries or silos where exposure to flammable gas or dust is a concern. The DXN's compact size and durable construction makes them easy to handle and well suited for in-line connections of electrical equipment. When used to connect modular equipment, DXN's provide plug and play simplicity and help reduce costs by eliminating the need for expensive safety enclosures. With DXN's installed, users can safely connect or disconnect equipment under full load in potentially explosive areas. The DXN's dead front construction assures electrical safety by preventing user access to live parts. IP66 + 67 ratings are achieved as soon as the plug and receptacle are mated, making them the perfect choice for wet or dusty environments.

### Main Advantages

- ▼ Easy to handle due to compact, lightweight design
- ▼ Available in in-line and wall/panel mounted configurations
- ▼ CSA and ATEX rated for use in Zones 1 and 2 (gas) and Zones 21 and 22 (dust).

# Product Features



### Pushbutton Pawl

Provides quick, safe and easy current interruption.

### Silver-Nickel Contacts

Silver-nickel contact material provides superior conductivity, durability and corrosion resistance.

### Hazardous Duty Termination Areas

Includes enhanced creepage and clearance distances and specially designed terminals to ensure perfect and permanent clamping.

### Casing

Self-extinguishing, non-static, material provides outstanding resistance to mechanical abuse and chemicals.

### Lid

When closed, the lid maintains NEMA 4X, IP66 + 67 protection for the receptacle after removal of the plug.

### Spring Loaded Butt-Style Contacts

Ensures optimal contact force and superior electrical performance over thousands of operations.

### Explosion Proof Arc Chamber

Withstands internal pressure due to gas/dust ignited by arcing and isolates it from the outside environment.

### Explosion Proof Pathways

Dissipates internal pressure created during arcing while also preventing any associated ignition sources from reaching the surrounding atmosphere.

## Operating Instructions



To connect, align the red dots, push the plug partially in, then turn clockwise slightly to line up the latch with the catch.



Push the plug fully home until it is held in place by the latch. The circuit is now closed.



To disconnect, depress the latch and pull the plug simultaneously. This breaks the circuit. The plug contacts are now dead.



Rotate 30° counterclockwise and then withdraw the plug. The safety shutter prevents access to live parts.

## General Ratings

Amperage	20 to 60A
Voltage	600 VAC*, 250 VDC Max
Frequency	50-400 Hz
Environmental	NEMA 4X, IP66 + 67
Temperature	min -40°F/max 140°F

\* DXN1 devices are 480 VAC  
DXN3 and DXN6 devices are 550VAC if ordered with optional auxiliary contacts

## Hazardous Duty Listings

CSA	ATEX
Class I, Zone 1 Ex IIC T6	II 2 G/D Dust T85°C EEx ed IIC
Class I, Zone 1 AEx, de IIC T6	
Class I Division 2 Gr A, B, C, D	
Class II Division 2 Gr E, F, G	

\* See following page for additional ratings detail

## Plug & Receptacle Listings

Category	CSA	IEC
Plugs and Receptacles	C22.2 No. 182.1	60309-1

CE ratings available upon request

## Highlighted Feature

### Dead Front



The dead front on the DXN receptacle provides protection from accidental tool and wire insertion.

# DXN Certifications

## Hazardous Duty Certification

DXN's have CSA and ATEX certifications for use in hazardous locations.



### CSA

**Class I, Zone 1, Ex de IIC T6**

**Class I, Zone 1, AEx de IIC T6**

**Class I Division 2 Gr A,B,C,D**

**Class I** – Indicates suitability for use in applications where flammable Gases, Vapors, or Mists may be present.

**Zone I** – Indicates suitability for use in applications where an explosive environment is likely to occur.

**Division 2** – Indicates suitability for use where exposure to the hazard occurs under abnormal conditions.

**GR A,B,C,D** – Indicates suitability for use in areas that may contain Acetylene, Hydrogen, Ethylene, or Propane.

**Class II Division 2 Gr E,F,G**

**Class II** – Indicates suitability for use in applications where dust may occur.

**Division 2** – Indicates suitability for use where hazard exposure occurs under abnormal conditions.

**GR E,F,G** – Indicates suitability for use in areas where Magnesium, Coal or Grain dust may occur.

*CSA certification based on IEC 60079-0, 60079-1, 60079-7*

### ATEX

**II 2 G/D DUST T85°C EEx ed IIC T6**

**II** – Indicates suitability for installation in surface applications (as opposed to underground mine applications).

**2** – Indicates suitability for use where a high level of protection is required and where the presence of an explosive atmosphere is likely to occur (Zone 1 and Zone 21 environments).

**G/D** – Indicates suitability for installation in areas that may contain flammable gases, vapors/mists, or dusts.

**T85°C** – Indicates a maximum surface temperature of the product of 85°C, at 40°C ambient.

**EEx ed** – Indicates that explosion protection is provided with (e) increased safety in the conductor termination area, and (d) explosion proof chambers for making and breaking the current that can withstand the pressure of internal ignition and that prevent arcs, flame or other ignition events from being communicated to the surrounding atmosphere.

**IIC** – Indicates suitability for installation in areas where exposure to any type of gas, including the most dangerous subdivision C gases may occur.

**T6** – Temperature class – the maximum product surface temperature is 185°F (85°C) for ambient temperature of 104°F (40°).

*ATEX certification was performed by LCIE.*

## Electrical Performance Testing

Key Performance Tests Passed					
Model	Mechanical Endurance	Electrical Endurance <sup>1</sup>	Overload Testing <sup>2</sup>	Temperature Rise (max)	Dielectric Test
DXN20	-	5000 Operations	50 Operations	30°C	2 x V (rated) + 1000V
DXN30	1000 Cycles	1000 Operations	50 Operations	30°C	2 x V (rated) + 1000V
DXN60	1000 Cycles	1000 Operations	50 Operations	30°C	2 x V (rated) + 1000V

<sup>1</sup> @ 100% of rated current and voltage and 0.6 power factor    <sup>2</sup> @ 125% of rated current, 110% of rated voltage, & 0.6 power factor

# DXN Operation

Arcing is a natural occurrence when electrical contacts make and break under load. The purpose of a hazardous duty product is to prevent arcing from igniting hazardous gases or dusts present in the atmosphere into an explosion that may cause personal injury or damage to facilities and equipment. The DXN accomplishes this with specially designed explosion-proof arc chambers.

The arc chambers are sized to minimize the amount of atmospheric gas or air/dust mixture that may ignite during arcing and are built to contain this internal mini-explosion and withstand the pressure that it generates. The length and width of the explosion-proof pathways are very precisely designed to provide for the effective dissipation of the pressure, while also ensuring that the arcing and internal ignitions of gases or air/dust mixture in the arc chamber are totally isolated from the surrounding atmosphere.

- 1 When the plug and receptacle are connected, the explosion-proof arc chamber is completed with pressure relief/arc extinguishing pathways between the outer diameter of the plug contact and its associated contact hole in the safety shutter and between the main interior component and receptacle contact base.
- 2 DXN's are current interrupting rated devices. They can safely make and break under full load and also during moderate overload situations. During the making or breaking of the contacts, the arc chamber completely contains any ignitions of gas or dust due to arcing and the explosion-proof pathways dissipate the pressure.
- 3 As the plug is being inserted or removed, the explosion-proof arc chamber and pathways are maintained. This ensures continuous hazardous duty protection and the safety of the user.
- 4 When the plug and receptacle are disconnected, the receptacle maintains an explosion proof chamber. In this case, the explosion-proof pathway exists between the safety shutter and the main interior component. The shutter also prevents access to live parts, providing users with the safety of a dead front. The plug must be inserted into the safety shutter and be rotated in order to access the receptacle contacts.

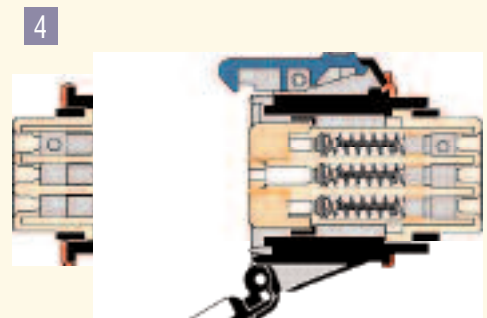
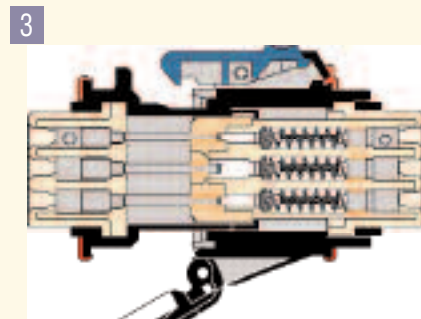
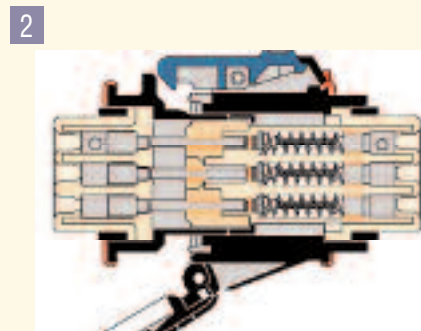
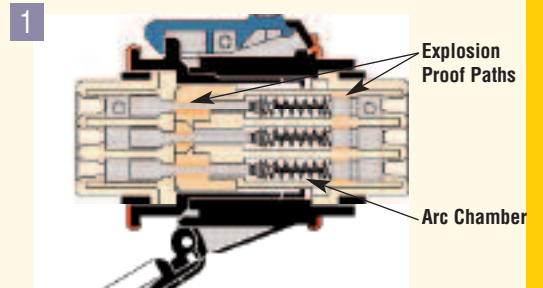



# DXN – 20A Hazardous Duty Plugs & Receptacles

## Ratings

- **Voltage**  
480 VAC, 250 VDC
- **Current Interruption Capability**  
For current interrupting (AC)
- **Environmental Ratings**  
NEMA 4X, IP66 + 67
- **Temperature Range**  
Min -40°F/Max 140°F  
See pg 194 for temps below -15°F.
- **Wiring Capacity\***  
Min 20 AWG Max 10 AWG  
\*Based on THHN wire sizes
- **Listings**  
CSA, IEC, ATEX

## Receptacle (female)

## Inlet (male)



Voltage	Polarity	Part # Poly
125V	1P+N+E	22-14075
208V	2P+E	22-14162
208V	3P+E	22-14163
208V	3P+N+E	22-14167
250V	2P+E	22-14072
250V	3P+E	22-14073
250V	2P+N+E	22-14076
277V	1P+N+E	22-14045
480V	2P+E	22-14042
480V	3P+E	22-14043
480V	3P+N+E	22-14047

Voltage	Polarity	Part # Poly
125V	1P+N+E	22-18075
208V	2P+E	22-18162
208V	3P+E	22-18163
208V	3P+N+E	22-18167
250V	2P+E	22-18072
250V	3P+E	22-18073
250V	2P+N+E	22-18076
277V	1P+N+E	22-18045
480V	2P+E	22-18042
480V	3P+E	22-18043
480V	3P+N+E	22-18047

Other voltage configurations are available – contact customer service at 800.433.7642.

## Main Options



**Padlock Pawl**



**Normally Closed Lid Configuration (unlatched)**



**180° Lid Opening (for connecting to wall mounted inlets)**

## Receptacle Options

## Part #

Padlock Pawl	Recept # - 843
Closed Lid Configuration	Recept # - R
180° Lid Opening	Recept # - 180

## Inlet Options

## Part #

No Lockout Hole	Recept # - A155
-----------------	-----------------

See pgs 171-180 for detailed information on these options

### DXN20 Order Example:

To order a padlock pawl on a receptacle, add **-843** to the part number.

DXN20 Poly receptacle 3P+E=22-14043-**843**

Appropriate accessory part numbers must also be included on the order.

# Installation Accessories

## Handles



Cable Range	Poly Handle w/Clamp & Bushing
.31 - .51	22-1A013-20P
.51 - .75	22-1A013-25P
.67 - .98	22-1A013-32P

## NPT Guidelines

Cable Range	NPT
.062 - .5	1/2"
.187 - .75	3/4"

NPT sizes are determined by the cable diameter and third party cord grip.

## Angles



Nylon 30° Angle
22-1A027

## Wall Boxes



NPT	Poly 30° Wall Box	Poly 70°* Wall Box
1/2"	22-1A023-12	22-1AB58
3/4"	22-1A023-34	-

**Notes:** • 70° wall boxes are ATEX rated only, CSA pending.  
• Knockout hole provided.

## Miscellaneous Accessories



Set of Two (2)



For Male Devices Only

Finger Drawplates	Protective Cap
61-1A346	22-1A126

## Accessory Spotlight

### Finger Drawplates



Finger drawplates are recommended for easier connector closure on cord to cord assemblies.

## Order Example

A typical order should include an inlet part number, a receptacle part number **AND** the matching handles, angles or other required accessories.



**Male Inlet with Handle (Plug)**  
22-18043 + 22-1A013-20P



**Female Receptacle with Wall Box**  
22-14043 + 22-1A023-12





# DXN – 30A Hazardous Duty Plugs & Receptacles

## Ratings

- **Voltage**  
600VAC, 250VDC
- **Current Interruption Capability**  
For current interrupting (AC)
- **Environmental Ratings**  
NEMA 4X, IP66 + 67
- **Temperature Range**  
Min -40°F/Max 140°F  
See pg 194 for temps below -15°F.
- **Wiring Capacity\***  
Min 14 AWG Max 6 AWG  
Aux Contacts - Max 10 AWG  
\*Based on THHN wire sizes
- **Listings**  
CSA, IEC, ATEX

## Receptacle (female)

## Inlet (male)



Don't forget to add installation accessories to your order



Standard DXN20 lid opens to 120°



Voltage	Polarity	Part # Poly
125V	1P+N+E	22-34075
208V	2P+E	22-34162
208V	3P+E	22-34163
208V	3P+N+E	22-34167
250V	2P+E	22-34072
250V	3P+E	22-34073
250V	2P+N+E	22-34076
277V	1P+N+E	22-34045
480V	2P+E	22-34042
480V	3P+E	22-34043
480V	3P+N+E	22-34047
600V	2P+E	22-34142
600V	3P+E	22-34143
600V	3P+N+E	22-34147

Voltage	Polarity	Part # Poly
125V	1P+N+E	22-38075
208V	2P+E	22-38162
208V	3P+E	22-38163
208V	3P+N+E	22-38167
250V	2P+E	22-38072
250V	3P+E	22-38073
250V	2P+N+E	22-38076
277V	1P+N+E	22-38045
480V	2P+E	22-38042
480V	3P+E	22-38043
480V	3P+N+E	22-38047
600V	2P+E	22-38142
600V	3P+E	22-38143
600V	3P+N+E	22-38147

Other voltage configurations are available – contact customer service at 800.433.7642.

## Main Options



**Padlock Pawl**



**Normally Closed Lid Configuration (unlatched)**



**180° Lid Opening (for connecting to wall mounted inlets)**

## Receptacle Options

## Part #

With 2 Auxiliary/Pilot Contacts*	Recept # - 972
Padlock Pawl	Recept # - 843
Closed Lid Configuration	Recept # - R
180° Lid Opening	Recept # - 180

## Inlet Options

## Part #

With 2 Auxiliary/Pilot Contacts*	Inlet # - 972
No Lockout Hole	Inlet # - A155

\* Not available with 600V devices, use -972-S74 for 480-550VAC

See pgs 171-180 for detailed information on these options

### DXN30 Order Example:

To order 2 auxiliary/pilot contacts on an inlet and receptacle add **-972** to the part numbers.

DXN30 Poly inlet 3P+E=22-38043-**972**

DXN30 Poly receptacle 3P+E=22-34043-**972**

Appropriate accessory part numbers must also be included on the order.

# Installation Accessories

## Handles



Cable Range	Poly Handle
.31 - .51	22-3A013-20P
.51 - .75	22-3A013-25P
.67 - .98	22-3A013-32P
.95 - 1.26	22-3A013-40P

## NPT Guidelines

Cable Range	NPT
.187 - .75	3/4"

NPT sizes are determined by the cable diameter and third party cord grip.

## Angles Wall Boxes



Nylon 30° Angle	NPT	Poly 30° Wall Box	Poly 70° Wall Box
22-3A027	3/4"	22-3A023-34	22-3AB58

**Notes:** • 70° wall boxes are ATEX rated only, CSA pending.  
• Knockout hole provided.

## Miscellaneous Accessories



Set of Two (2)



For Male Devices Only

Finger Drawplates	Protective Cap
61-3A346	22-3A126

## Accessory Spotlight

### Finger Drawplates



Finger drawplates are recommended for easier connector closure on cord to cord assemblies.

## Order Example

A typical order should include an inlet part number, a receptacle part number **AND** the matching handles, angles or other required accessories.



**Male Inlet with Handle (Plug)**  
22-38043 + 22-3A013-25P



**Female Receptacle with Wall Box**  
22-34043 + 22-3A023-34



# DXN – 60A Hazardous Duty Plugs & Receptacles

## Ratings

- **Voltage**  
600VAC, 250VDC
- **Current Interruption Capability**  
For current interrupting (AC)
- **Environmental Ratings**  
NEMA 4X, IP66 + 67
- **Temperature Range**  
Min -40°F/Max 140°F  
See pg 194 for temps below -15°F.
- **Wiring Capacity\***  
Min 10 AWG Max 4 AWG  
Aux Contacts - Max 10 AWG  
\* Based on THHN wire sizes
- **Listings**  
CSA, IEC, ATEX

## Receptacle (female)

## Inlet (male)



Don't forget to add installation accessories to your order



Standard DXN20 lid opens to 120°



Voltage	Polarity	Part # Poly
125V	1P+N+E	22-64075
208V	2P+E	22-64162
208V	3P+E	22-64163
208V	3P+N+E	22-64167
250V	2P+E	22-64072
250V	3P+E	22-64073
250V	2P+N+E	22-64076
277V	1P+N+E	22-64045
480V	2P+E	22-64042
480V	3P+E	22-64043
480V	3P+N+E	22-64047
600V	2P+E	22-64142
600V	3P+E	22-64143
600V	3P+N+E	22-64147

Voltage	Polarity	Part # Poly
125V	1P+N+E	22-68075
208V	2P+E	22-68162
208V	3P+E	22-68163
208V	3P+N+E	22-68167
250V	2P+E	22-68072
250V	3P+E	22-68073
250V	2P+N+E	22-68076
277V	1P+N+E	22-68045
480V	2P+E	22-68042
480V	3P+E	22-68043
480V	3P+N+E	22-68047
600V	2P+E	22-68142
600V	3P+E	22-68143
600V	3P+N+E	22-68147

Other voltage configurations are available – contact customer service at 800.433.7642.

## Main Options



**Padlock Pawl**



**Normally Closed Lid Configuration (unlatched)**

## Receptacle Options

## Part #

With 2 Auxiliary/Pilot Contacts*	Recept # - 972
Padlock Pawl	Recept # - 843
Closed Lid Configuration	Recept # - R
180° Lid Opening	Recept # - 180

## Inlet Options

## Part #

With 2 Auxiliary/Pilot Contacts*	Inlet # - 972
----------------------------------	---------------

\* Not available with 600V devices, use -972-S74 for 480-550 VAC.

### DXN60 Order Example:

To order 2 auxiliary/pilot contacts on an inlet and receptacle add **-972** to the part numbers.

DXN60 Poly inlet 3P+E=22-68043-**972**

DXN60 Poly receptacle 3P+E=22-64043-**972**

Appropriate accessory part numbers must also be included on the order.

See pgs 171-180 for detailed information on these options

# Installation Accessories

## Handles



Cable Range	Poly Handle w/Clamp & Bushing
.51 - .75	22-6A013-25P
.67 - .98	22-6A013-32P
.95 - 1.26	22-6A013-40P

## NPT Guidelines

Cable Range	NPT
.437 - 1.10	1"

NPT sizes are determined by the cable diameter and third party cord grip.

## Angles Wall Boxes



Nylon 30° Angle	NPT	Poly 30° Wall Box	Poly 70° Wall Box
22-6A027	1"	22-6A023-1	22-6AB58

**Notes:** • 70° wall boxes are ATEX rated only, CSA pending.  
• Knockout hole provided.

## Accessory Spotlight

### Finger Drawplates



Finger drawplates are recommended for easier connector closure on cord to cord assemblies.

## Miscellaneous Accessories



Set of Two (2)



For Male Devices Only

Finger Drawplates	Protective Cap
61-6A346	22-6A126

## Order Example

A typical order should include an inlet part number, a receptacle part number **AND** the matching handles, angles or other required accessories.



**Male Inlet with Handle (Plug)**  
22-68043 + 22-6A013-32P



**Female Receptacle with Wall Box**  
22-64043 + 22-6A023-1



# Dimensions

## Inlet – Provided in inches and millimeters

Dimensions are for reference only

### plug

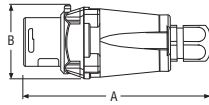

PRODUCT	A	B
	5.00	2.01
DXN20	127	51
	5.04	2.68
DXN30	128	68
	5.87	3.27
DXN60	149	83

### Inlet

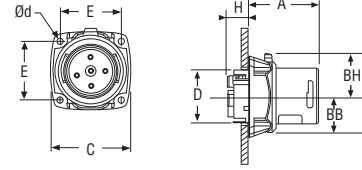

PRODUCT	A	BB	BH	C	D	E	H	Ød
	1.97	0.94	1.06	2.24	1.46	1.65	0.53	0.17
DXN20	50	24	27	57	37	42	13.5	4.2
	1.97	1.26	1.42	2.64	2.28	1.89	0.51	0.18
DXN30	50	32	36	67	58	48	13	4.5
	2.20	1.54	1.73	3.07	2.68	2.17	0.59	0.19
DXN60	56	39	44	78	68	55.2	15	4.8

### 30° inclined inlet/angle with connector on/off

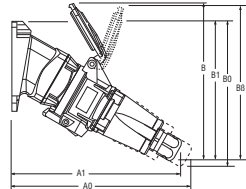

PRODUCT	A1	A0	B	B1	B0	BB
	8.15	8.58	6.61	6.61	6.89	
DXN20	207	218	168	168	175	
	7.99	8.58	8.19	6.02	6.65	
DXN30	203	218	208	153	169	
	9.13	10.16	9.29	7.32	7.91	8.39
DXN60	232	258	236	186	201	213

### 30° inlet/conduit box

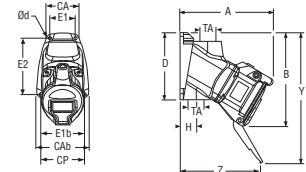

PRODUCT	A	B	CA	CAB	CP	D	E1	E1b	E2	H	PG	Ød
	4.53	4.45	1.77	2.68	2.24	3.54	1.42	2.20	3.07	1.48	0.50	0.18
DXN20	115	113	45	68	57	90	36	56	78	37.5		4.5
	4.41	4.13	3.31	3.31	2.64	4.21	2.76	2.76	2.76	0.69	0.50	0.24
DXN30	112	105	84	84	67	107	70	70	70	17.5		6
	5.20	5.04	3.50		3.07	4.80	3.03	3.46	0.94	0.26		0.26
DXN60	132	128	89		78	122	77	88	24	6.5		6.5

### 30° inclined inlet/conduit box with connector on/off

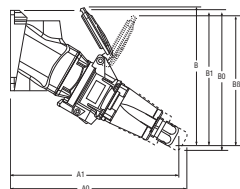

PRODUCT	A1	A0	B	B1	B0	BB
	8.15	8.58	6.61	6.61	6.89	
DXN20	207	218	168	168	175	
	7.99	8.58	8.19	6.02	6.65	
DXN30	203	218	208	153	169	
	9.13	10.16	9.29	7.32	7.91	8.43
DXN60	232	258	236	186	201	214

### 30° inlet/angle

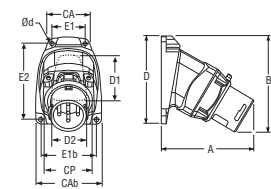

PRODUCT	A	B	CA	CAB	CP	D	D1	D2	E1	E1b	E2	Ød
	3.78	4.02	1.77	2.68	2.24	3.54	2.95	1.97	1.42	2.20	3.07	0.18
DXN20	96	102	45	68	57	90	75	50	36	56	78	4.5
	3.66	4.49	2.99	2.99	2.64	4.21	2.56	3.74	2.48	2.48	3.74	0.22
DXN30	93	114	76	76	67	107	65	95	63	63	95	5.5
	4.06	4.80	2.99	2.99	3.07	4.21	2.56	3.74	2.48	2.48	3.74	0.22
DXN60	103	122	76	76	78	107	65	95	63	63	95	5.5

### 70° inclined inlet/wall box with connector on/off

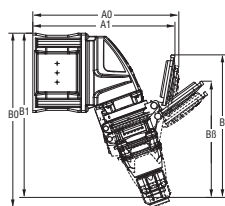

PRODUCT	A1	A0	B	B1	B0	BB
	8.35	8.54	7.68	10.04	10.51	
DXN20	212	217	195	255	267	
	8.50	8.70	8.82	10.12	10.75	
DXN30	216	221	224	257	273	
	9.88	10.28	9.92	12.24	13.43	6.77
DXN60	251	261	252	311	341	172

### 70° inlet/wall box

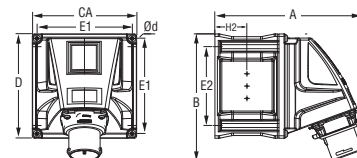

PRODUCT	A	B	CA	D	E1	E2	Ød
	6.77	6.14	5.08	5.08	4.69	3.90	0.17
DXN20	172	156	129	129	119	99	4.2
	6.93	6.26	5.08	5.08	4.69	3.90	0.17
DXN30	176	159	129	129	119	99	4.2
	8.31	7.99	6.81	6.81	6.22	5.47	0.26
DXN60	211	203	173	173	158	139	6.5

# Dimensions

## Receptacle – Provided in inches and millimeters

Dimensions are for reference only

### connector

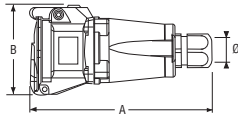

PRODUCT	A	B	Ø
DXN20	5.16	3.07	.32-.59
	131	78	8-15
	6.38	4.06	.32-.90
DXN30	162	103	8-23
	6.77	4.53	
DXN60	172	115	

### receptacle with plug on/off

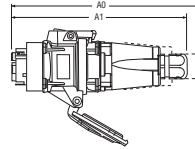

PRODUCT	A1	A0
DXN20	6.14	6.65
	156	169
	6.65	7.32
DXN30	169	186
	6.89	8.03
DXN60	175	204

### receptacle

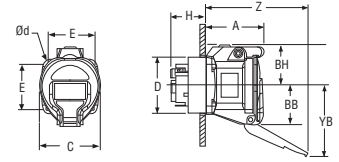

PRODUCT	A	BB	BH	C	D	E	H	YB	Z	Ød
DXN20	2.07	1.57	1.50	2.24	1.99	1.65	0.98	2.76	3.84	0.17
	52.7	40	38	57	50.5	42	25	70	97.5	4.2
DXN30	2.61	2.09	1.97	2.87	2.28	1.89	0.59	3.86	4.47	0.18
	66.2	53	50	73	58	48	15	98	113.6	4.5
DXN60	3.12	2.30	2.20	3.23	2.68	2.17	0.71	4.65	4.76	0.19
	79.2	58.5	56	82	68	55.2	18	118	121	4.8

### 30° inclined receptacle/angle with plug on/off

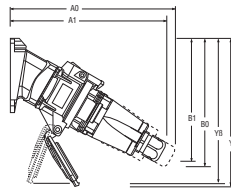

PRODUCT	A1	A0	B1	B0	Y	YB
DXN20	7.40	7.83	6.18	6.46	6.65	
	188	199	157	164	169	
	7.24	7.83	6.69	7.01	8.23	
DXN30	184	199	170	178	209	
	7.99	9.02	7.09	7.68	9.06	8.15
DXN60	203	229	180	195	230	207

### 30° receptacle/angle

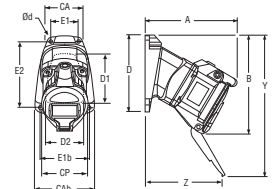

PRODUCT	A	B	CA	CAB	CP	D	D1	D2	E1	E1b	E2	Y	Z	Ød
DXN20	4.25	4.72	1.77	2.68	2.24	3.54	2.95	1.97	1.42	2.20	3.07	6.65	3.62	0.18
	108	120	45	68	57	90	75	50	36	56	78	169	92	4.5
DXN30	4.69	5.55	2.99	2.99	2.87	4.21	2.56	3.74	2.48	2.48	3.74	8.23	3.39	0.22
	119	141	76	76	73	107	65	95	63	63	95	209	86	5.5
DXN60	5.35	6.14	2.99	2.99	3.23	4.21	2.56	3.74	2.48	2.48	3.74	9.06	3.35	0.22
	136	156	76	76	82	107	65	95	63	63	95	230	85	5.5

### 30° inclined receptacle/conduit box with plug on/off

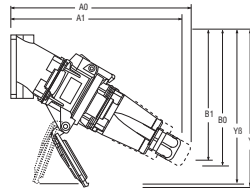

PRODUCT	A1	A0	B1	B0	Y	YB
DXN20	8.15	8.58	6.61	6.89	7.09	
	207	218	168	175	180	
	7.99	8.58	6.34	6.65	7.87	
DXN30	203	218	161	169	200	
	9.13	10.16	7.32	7.91	9.29	8.15
DXN60	232	258	186	201	236	207

### 30° receptacle/conduit box

PRODUCT	A	B	CA	CAB	CP	D	E1	E1b	E2	H	PG	Y	Z	Ød
DXN20	5.00	5.16	1.77	2.68	2.24	3.54	1.42	2.20	3.07	1.48	0.50	7.09	4.37	0.18
	127	131	45	68	57	90	36	56	78	37.5		180	111	4.5
DXN30	5.43	5.20	3.31	3.31	2.87	4.21	2.76	2.76	0.69	0.50	7.87	4.13	0.24	
	138	132	84	84	73	107	70	70	17.5			200	105	6
DXN60	6.50	6.38	3.50		3.23	4.80	3.03		3.46	0.94		9.29	4.49	0.26
	165	162	89		82	122	77		88	24		236	114	6.5

### 70° inclined receptacle/wall box with plug on/off

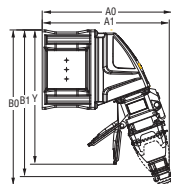

PRODUCT	A1	A0	B1	B0	Y	YB
DXN20	8.35	8.54	10.04	10.51	8.58	
	212	217	255	267	218	
	8.50	8.70	10.12	10.75	9.61	
DXN30	216	221	257	273	244	
	9.88	10.28	12.24	13.35	11.57	8.39
DXN60	251	261	311	339	294	213

### 70° receptacle/wall box

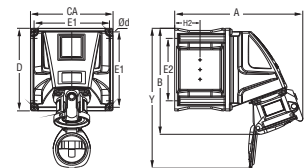

PRODUCT	A	B	CA	D	E1	E2	Ød
DXN20	7.52	6.42	5.08	5.08	4.69	3.90	0.17
	191	163	129	129	119	99	4.2
DXN30	8.03	6.85	5.08	5.08	4.69	3.90	0.17
	204	174	129	129	119	99	4.2
DXN60	9.57	9.09	6.81	6.81	6.22	5.47	0.26
	243	231	173	173	158	139	6.5

# DX



Features and Ratings	p. 79
Certifications and Testing	p. 81
DX Operation	p. 82
DX20	p. 83
DX30	p. 84
DX60	p. 85
DX100	p. 86
Dimensions	p. 87



## Hazardous duty rated plugs and receptacles

DX Series plugs and receptacles are heavy duty metallic devices that are a good choice for refineries, petroleum platforms, chemical and pharmaceutical plants, grain silos and other locations where exposure to flammable gases and/or dusts is likely to occur. DX's are ATEX rated and they have also been tested and approved by ETL for operation under load in a gaseous environment (14.5% acetylene). This is one of the key performance tests required for UL Class 1, Division 1 products.

### Main Advantages

- ▼ Rugged Construction, cost effective design
- ▼ ATEX II 2 G/D T85°C Eex ed IIC T6 rated for Zone 1 and Zone 21 applications

# Product Features

**Heavy Duty Aluminum Casing**  
All components are enclosed in rugged copper free aluminum housings for maximum durability and protection.

**Explosion Proof Chamber**  
The making and breaking of the contacts occurs in an explosion proof chamber, which is specially designed to withstand the pressure generated during arcing and to ensure that no arc, flame or other ignition source can be communicated with the external environment.

**Spring Operated Switching Mechanism**  
An integral switching mechanism ensures quick-make, quick-break operation, independent of the motion of the user.

**Silver-Nickel Butt Contacts**  
Contact design provides a superior connection, with maximum conductivity, the ability to withstand arcing and oxidation, excellent wear resistance, and a long operating life. A wiping motion during operation also provides a self-cleaning action.

**Dead Front**  
The 'dead' load-side switching contacts block access to the receptacle and are locked in the open position until an appropriate mating plug is fully inserted. This prevents unintended access to live parts and ensures user safety.

**ON & OFF Positions when Mated**  
The operation of the switching mechanism allows the circuit to be disconnected without removing the plug.

**Normally Closed Receptacle Lid**  
The lid automatically closes to a pre-latched position when the plug is removed. This prevents the entry of dust and debris. The lid must be manually latched to maintain IP 65 protection.

## General Ratings

<b>Amperage</b>	20 to 100A
<b>Voltage</b>	600 VAC Max
<b>Frequency</b>	50-400 Hz
<b>Environmental</b>	IP65
<b>Temperature</b>	min -5°F/max 120°F*

\* DX20 and DX30 only. DX60 and DX100 are max 105°F

## Highlighted Feature

### Dead Front

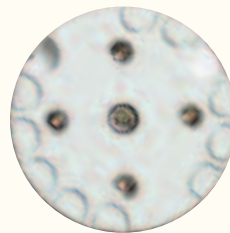

The dead front on the DX receptacle provides protection from accidental tool and wire insertion.

## Operating Instructions

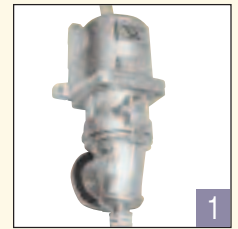

When a DX is connected there is total safety.

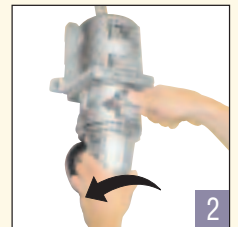

Pressing the pawl while turning the plug about 30° counterclockwise causes the circuit to be broken.

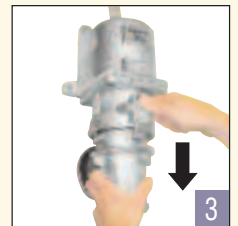

Press the pawl while withdrawing the plug from the receptacle. This is done in complete safety because the circuit is already dead.



The plug and receptacle are separated. The safety shutter prevents access to live parts.

**5** To reconnect, insert plug into receptacle fully, then twist the plug approximately 30° clockwise to make the circuit.



# DX Certifications

## Hazardous Duty Certification

### ATEX

#### II 2 G/D DUST T85°C EEx ed IIC T6

- II** – Indicates suitability for installation in surface applications (as opposed to underground mine applications).
- 2** – Indicates suitability for use where a high level of protection is required and where the presence of an explosive atmosphere is likely to occur (Zone 1 and Zone 21 environments).
- G/D** – Indicates suitability for installation in areas that may contain flammable gases, vapors/mists, or dusts.
- T85°C** – Indicates a maximum surface temperature of the product of 85°C, at 40°C ambient.
- EEx ed** – Indicates that explosion protection is provided with (e) increased safety in the conductor termination area, and (d) explosion proof chambers for making and breaking the current that can withstand the pressure of internal ignition and that prevent arcs, flame or other ignition events from being communicated to the surrounding atmosphere.
- IIC** – Indicates suitability for installation in areas where exposure to any type of gas, including the most dangerous subdivision C gases may occur.
- T6** – Temperature class – the maximum product surface temperature is 185°F (85°C) for ambient temperature of 104°F (40°).

*ATEX certification was performed by LCIE.*

## Electrical Performance Testing

Key Performance Tests Passed				
Model	Mechanical Endurance	Electrical Endurance <sup>1</sup>	Overload Testing <sup>2</sup>	Dielectric Test
DX20	-	5000 Operations	50 Operations	2 x V (rated) + 1000V
DX30	1000 Cycles	1000 Operations	50 Operations	2 x V (rated) + 1000V
DX60	1000 Cycles	1000 Operations	50 Operations	2 x V (rated) + 1000V
DX100	1000 Cycles	1000 Operations	50 Operations	2 x V (rated) + 1000V

<sup>1</sup> @ 100% of rated current and voltage and 0.6 power factor    <sup>2</sup> @ 125% of rated current, 110% of rated voltage, & 0.6 power factor

# DX Operation

## Connection

1

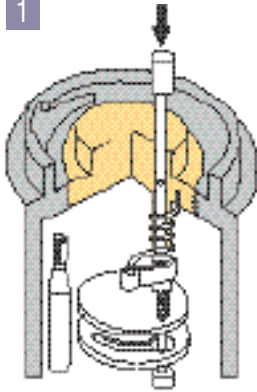

### Insertion of the Plug

As the plug contact is inserted, it engages and depresses the 'dead' switching contact. This releases the locking mechanism. The switching contact is free to operate.

2

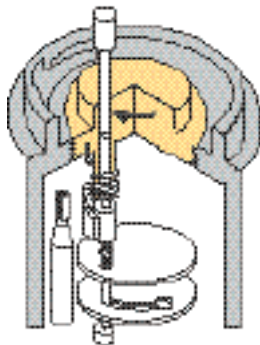

### Charging the Operating Spring

Clockwise rotation of the inserted plug winds the operating spring and rotates the switching contact into position to engage with the live receptacle contact.

3

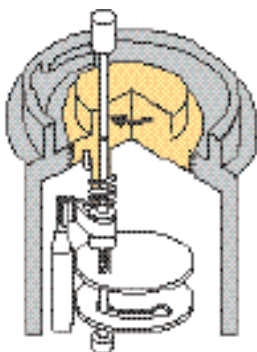

### Making the Circuit

With the final few degrees of rotation, the switching contact is released and force from the spring quickly drives it into engagement with the live receptacle contact.

## Disconnection

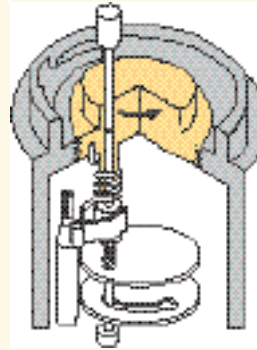

After depressing the pawl, the plug is rotated in a counter-clockwise direction. This frees the switching contact for operation and the release of the remaining spring tension causes a quick breaking of the contacts. The plug may now be removed, if desired.

## Receptacle with Plug Disconnected

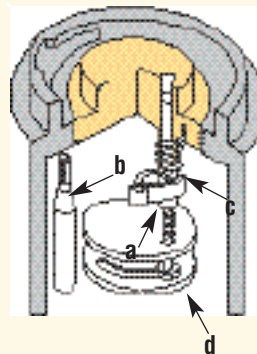

- a. **Switching Contact**  
Shown in the open (dead) position
- b. **'Live' Receptacle Contact**  
Accessibility is denied
- c. **Operating Spring**  
Shown with tension released
- d. **Mechanical Locking Device**  
Blocks contact operation



# DX – 20A Hazardous Duty Plugs & Receptacles

### Ratings

- **Voltage**  
600 VAC
- **Environmental Ratings**  
IP65
- **Temperature Range**  
Min -5°F/Max 120°F
- **Wiring Capacity\***  
Min 14 AWG Max 6 AWG  
\*Based on THHN wire sizes
- **Listings**  
ATEX

### XXXX Suffix / Cable Range

XXXX (Suffix #)	Cable Range
-CG1275	.125 - .250
-CG2575	.250 - .375
-CG3775	.375 - .500
-CG5075	.500 - .625
-CG6275	.625 - .750
-CG7575	.750 - .875

### XX Suffix / NPT Size

NPT Thread Size	XX (Suffix #)
1/2"	-12
3/4"	-34
1"	-1

NPT sizes are determined by the cable diameter and third party cord grip.

### Accessories

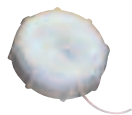

For Male Devices Only

**Protective Cap**

**Part #**

DX20 26-2A126



**Surface Box**

**Part #**

1/2" 26-2A023-12

3/4" 26-2A023-34

1" 26-2A023-1

### Plug (male inlet w/handle)



Replace XXXX or XX with suffix number to indicate desired cable range (see chart)

Voltage	Polarity	Part # Metal
125V	1P+N+E	26-21075-XXXX
208V	2P+E	26-21162-XXXX
208V	3P+E	26-21163-XXXX
208V	3P+N+E	26-21167-XXXX
250V	2P+E	26-21072-XXXX
250V	3P+E	26-21073-XXXX
250V	2P+N+E	26-21076-XXXX
277V	1P+N+E	26-21045-XXXX
480V	2P+E	26-21042-XXXX
480V	3P+E	26-21043-XXXX
480V	3P+N+E	26-21047-XXXX
600V	3P+E	26-21143-XXXX

### Inlet w/cap on box (male)



or

Voltage	Polarity	Part # Metal
125V	1P+N+E	26-26075-XX
208V	2P+E	26-26162-XX
208V	3P+E	26-26163-XX
208V	3P+N+E	26-26167-XX
250V	2P+E	26-26072-XX
250V	3P+E	26-26073-XX
250V	2P+N+E	26-26076-XX
277V	1P+N+E	26-26045-XX
480V	2P+E	26-26042-XX
480V	3P+E	26-26043-XX
480V	3P+N+E	26-26047-XX
600V	3P+E	26-26143-XX

Other voltage configurations are available – contact customer service at 800.433.7642.

### Connector

(female receptacle w/handle)



### Receptacle on box

(female)



or

### Receptacle

(female)



or

Voltage	Polarity	Part # Metal	Part # Metal	Part # Metal
125V	1P+N+E	26-23075-XXXX	26-20075-XX	26-24075
208V	2P+E	26-23162-XXXX	26-20162-XX	26-24162
208V	3P+E	26-23163-XXXX	26-20163-XX	26-24163
208V	3P+N+E	26-23167-XXXX	26-20167-XX	26-24167
250V	2P+E	26-23072-XXXX	26-20072-XX	26-24072
250V	3P+E	26-23073-XXXX	26-20073-XX	26-24073
250V	2P+N+E	26-23076-XXXX	26-20076-XX	26-24076
277V	1P+N+E	26-23045-XXXX	26-20045-XX	26-24045
480V	2P+E	26-23042-XXXX	26-20042-XX	26-24042
480V	3P+E	26-23043-XXXX	26-20043-XX	26-24043
480V	3P+N+E	26-23047-XXXX	26-20047-XX	26-24047
600V	3P+E	26-23143-XXXX	26-20143-XX	26-24143

Other voltage configurations are available – contact customer service at 800.433.7642.

# DX – 30A

## Hazardous Duty Plugs & Receptacles

DX30

### Plug (male inlet w/handle)



Replace XXXX or XX with suffix number to indicate desired cable range (see chart)

or

### Inlet w/cap on box (male)

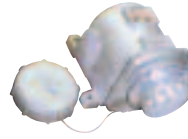

Voltage	Polarity	Part # Metal
125V	1P+N+E	26-31075-XXXX
208V	2P+E	26-31162-XXXX
208V	3P+E	26-31163-XXXX
208V	3P+N+E	26-31167-XXXX
250V	2P+E	26-31072-XXXX
250V	3P+E	26-31073-XXXX
250V	2P+N+E	26-31076-XXXX
277V	1P+N+E	26-31045-XXXX
480V	2P+E	26-31042-XXXX
480V	3P+E	26-31043-XXXX
480V	3P+N+E	26-31047-XXXX
600V	3P+E	26-31143-XXXX

Voltage	Polarity	Part # Metal
125V	1P+N+E	26-36075-XX
208V	2P+E	26-36162-XX
208V	3P+E	26-36163-XX
208V	3P+N+E	26-36167-XX
250V	2P+E	26-36072-XX
250V	3P+E	26-36073-XX
250V	2P+N+E	26-36076-XX
277V	1P+N+E	26-36045-XX
480V	2P+E	26-36042-XX
480V	3P+E	26-36043-XX
480V	3P+N+E	26-36047-XX
600V	3P+E	26-36143-XX

Other voltage configurations are available – contact customer service at 800.433.7642.

### Main Features

- **Voltage**  
600 VAC
- **Environmental Ratings**  
IP65
- **Temperature Range**  
Min -5°F/Max 120°F
- **Wiring Capacity**  
Min 14 AWG Max 6 AWG  
\* Based on THHN wire sizes
- **Listings**  
ATEX

### XXXX Suffix / Cable Range

XXXX (Suffix #)	Cable Range
-CG1275	.125 - .250
-CG2575	.250 - .375
-CG3775	.375 - .500
-CG5075	.500 - .625
-CG6275	.625 - .750
-CG7575	.750 - .875

### XX Suffix / NPT Size

NPT Thread Size	XX (Suffix #)
1/2"	-12
3/4"	-34
1"	-1

NPT sizes are determined by the cable diameter and third party cord grip.

### Accessories

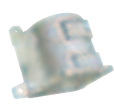
	<b>Protective Cap</b>
For Male Devices Only	
	<b>Part #</b>
DX30	26-3A126
	<b>Surface Box</b>
	<b>Part #</b>
NPT	
1/2"	26-3A023-12
3/4"	26-3A023-34
1"	26-3A023-1

### Connector (female receptacle w/handle)



or

### Receptacle on box (female)



or

### Receptacle (female)



Voltage	Polarity	Part # Metal	Part # Metal	Part # Metal
125V	1P+N+E	26-33075-XXXX	26-30075-XX	26-34075
208V	2P+E	26-33162-XXXX	26-30162-XX	26-34162
208V	3P+E	26-33163-XXXX	26-30163-XX	26-34163
208V	3P+N+E	26-33167-XXXX	26-30167-XX	26-34167
250V	2P+E	26-33072-XXXX	26-30072-XX	26-34072
250V	3P+E	26-33073-XXXX	26-30073-XX	26-34073
250V	2P+N+E	26-33076-XXXX	26-30076-XX	26-34076
277V	1P+N+E	26-33045-XXXX	26-30045-XX	26-34045
480V	2P+E	26-33042-XXXX	26-30042-XX	26-34042
480V	3P+E	26-33043-XXXX	26-30043-XX	26-34043
480V	3P+N+E	26-33047-XXXX	26-30047-XX	26-34047
600V	3P+E	26-33143-XXXX	26-30143-XX	26-34143

Other voltage configurations are available – contact customer service at 800.433.7642.

Courtesy of Gross Automation 1724 South Johnson Road New Berlin, WI PH: 262-446-0000 FAX: 262-446-0300 www.meltricsales.com



# DX – 60A Hazardous Duty Plugs & Receptacles

### Ratings

- **Voltage**  
600 VAC
- **Environmental Ratings**  
IP65
- **Temperature Range**  
Min -5°F/Max 105°F
- **Wiring Capacity\***  
Min 8 AWG Max 2 AWG  
\*Based on THHN wire sizes
- **Listings**  
ATEX

### XXXX Suffix / Cable Range

XXXX (Suffix #)	Cable Range
-CG75125	.750 - .875
-CG87125	.875 - 1.000
-CG100125	1.000 - 1.125
-CG112125	1.125 - 1.250
-CG125125	1.250 - 1.375
-CG137125	1.375 - 1.500

### XX Suffix / NPT Size

NPT Thread Size	XX (Suffix #)
1"	-1
1 1/4"	-114
1 1/2"	-112
2"	-2

NPT sizes are determined by the cable diameter and third party cord grip.

### Accessories



For Male Devices Only

**Protective Cap**

**Part #**

DX60 26-6A126



**Metal Wall Box**

**Part #**

1" 26-6A023-1

1 1/4" 26-6A023-114

1 1/2" 26-6A023-112

2" 26-6A023-2

### Plug (male inlet w/handle)



Replace XXXX or XX with suffix number to indicate desired cable range (see chart)

Voltage	Polarity	Part # Metal
125V	1P+N+E	26-61075-XXXX
208V	2P+E	26-61162-XXXX
208V	3P+E	26-61163-XXXX
208V	3P+N+E	26-61167-XXXX
250V	2P+E	26-61072-XXXX
250V	3P+E	26-61073-XXXX
250V	2P+N+E	26-61076-XXXX
277V	1P+N+E	26-61045-XXXX
480V	2P+E	26-61042-XXXX
480V	3P+E	26-61043-XXXX
480V	3P+N+E	26-61047-XXXX
600V	3P+E	26-61143-XXXX

### Inlet w/cap on box (male)



or

Voltage	Polarity	Part # Metal
125V	1P+N+E	26-66075-XX
208V	2P+E	26-66162-XX
208V	3P+E	26-66163-XX
208V	3P+N+E	26-66167-XX
250V	2P+E	26-66072-XX
250V	3P+E	26-66073-XX
250V	2P+N+E	26-66076-XX
277V	1P+N+E	26-66045-XX
480V	2P+E	26-66042-XX
480V	3P+E	26-66043-XX
480V	3P+N+E	26-66047-XX
600V	3P+E	26-66143-XX

Other voltage configurations are available – contact customer service at 800.433.7642.

### Connector (female receptacle w/handle)



or

### Receptacle on box (female)



or

### Receptacle (female)



Voltage	Polarity	Part # Metal	Part # Metal	Part # Metal
125V	1P+N+E	26-63075-XXXX	26-60075-XX	26-64075
208V	2P+E	26-63162-XXXX	26-60162-XX	26-64162
208V	3P+E	26-63163-XXXX	26-60163-XX	26-64163
208V	3P+N+E	26-63167-XXXX	26-60167-XX	26-64167
250V	2P+E	26-63072-XXXX	26-60072-XX	26-64072
250V	3P+E	26-63073-XXXX	26-60073-XX	26-64073
250V	2P+N+E	26-63076-XXXX	26-60076-XX	26-64076
277V	1P+N+E	26-63045-XXXX	26-60045-XX	26-64045
480V	2P+E	26-63042-XXXX	26-60042-XX	26-64042
480V	3P+E	26-63043-XXXX	26-60043-XX	26-64043
480V	3P+N+E	26-63047-XXXX	26-60047-XX	26-64047
600V	3P+E	26-63143-XXXX	26-60143-XX	26-64143

Other voltage configurations are available – contact customer service at 800.433.7642.

# DX – 100A

## Hazardous Duty Plugs & Receptacles

DX100

### Plug (male inlet w/handle)



Replace XXXX or XX with suffix number to indicate desired cable range (see chart)

or

### Inlet w/cap on box (male)



Voltage	Polarity	Part # Metal
125V	1P+N+E	26-91075-XXXX
208V	2P+E	26-91162-XXXX
208V	3P+E	26-91163-XXXX
208V	3P+N+E	26-91167-XXXX
250V	2P+E	26-91072-XXXX
250V	3P+E	26-91073-XXXX
250V	2P+N+E	26-91076-XXXX
277V	1P+N+E	26-91045-XXXX
480V	2P+E	26-91042-XXXX
480V	3P+E	26-91043-XXXX
480V	3P+N+E	26-91047-XXXX
600V	3P+E	26-91143-XXXX

Voltage	Polarity	Part # Metal
125V	1P+N+E	26-96075-XX
208V	2P+E	26-96162-XX
208V	3P+E	26-96163-XX
208V	3P+N+E	26-96167-XX
250V	2P+E	26-96072-XX
250V	3P+E	26-96073-XX
250V	2P+N+E	26-96076-XX
277V	1P+N+E	26-96045-XX
480V	2P+E	26-96042-XX
480V	3P+E	26-96043-XX
480V	3P+N+E	26-96047-XX
600V	3P+E	26-96143-XX

Other voltage configurations are available – contact customer service at 800.433.7642.

### Main Features

- **Voltage**  
600 VAC
- **Environmental Ratings**  
IP65
- **Temperature Range**  
Min -5°F/Max 105°F
- **Wiring Capacity\***  
Min 4 AWG Max 2 AWG  
\* Based on THHN wire sizes
- **Listings**  
ATEX

### XXXX Suffix / Cable Range

XXXX (Suffix #)	Cable Range
-CG75125	.750 - .875
-CG87125	.875 - 1.000
-CG100125	1.000 - 1.125
-CG112125	1.125 - 1.250
-CG125125	1.250 - 1.375
-CG137125	1.375 - 1.500

### XX Suffix / NPT Size

NPT Thread Size	XX (Suffix #)
1"	-1
1 1/4"	-114
1 1/2"	-112
2"	-2

NPT sizes are determined by the cable diameter and third party cord grip.

### Accessories

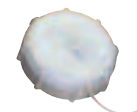

For Male Devices Only

**Protective Cap**

**Part #**

DX100 26-9A126



**NPT**

**Metal Wall Box**

**Part #**

1" 26-9A023-1  
1 1/4" 26-9A023-114  
1 1/2" 26-9A023-112  
2" 26-9A023-2

### Connector (female receptacle w/handle)



or

### Receptacle on box (female)



or

### Receptacle (female)



Voltage	Polarity	Part # Metal	Part # Metal	Part # Metal
125V	1P+N+E	26-93075-XXXX	26-90075-XX	26-94075
208V	2P+E	26-93162-XXXX	26-90162-XX	26-94162
208V	3P+E	26-93163-XXXX	26-90163-XX	26-94163
208V	3P+N+E	26-93167-XXXX	26-90167-XX	26-94167
250V	2P+E	26-93072-XXXX	26-90072-XX	26-94072
250V	3P+E	26-93073-XXXX	26-90073-XX	26-94073
250V	2P+N+E	26-93076-XXXX	26-90076-XX	26-94076
277V	1P+N+E	26-93045-XXXX	26-90045-XX	26-94045
480V	2P+E	26-93042-XXXX	26-90042-XX	26-94042
480V	3P+E	26-93043-XXXX	26-90043-XX	26-94043
480V	3P+N+E	26-93047-XXXX	26-90047-XX	26-94047
600V	3P+E	26-93143-XXXX	26-90143-XX	26-94143

Other voltage configurations are available – contact customer service at 800.433.7642.

Courtesy of Gross Automation 1724 South Johnson Road New Berlin, WI PH: 262-446-0000 FAX: 262-446-0300 www.meltricsales.com



# Dimensions

## Inlet – Provided in inches and millimeters

*Dimensions are for reference only*

### plug

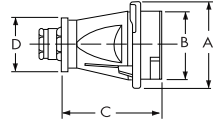

PRODUCT	A	B	C	D
	4.06	3.19	4.65	2.68
DX20/DX30	103	81	118	68
	5.75	4.65	8.66	3.94
DX60/DX100	146	118	220	100

### Inlet + Connector

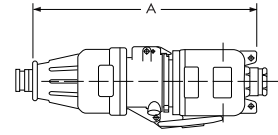

PRODUCT	A
	15.94
DX20/DX30	405
	24.88
DX60/DX100	632

# Dimensions

## Receptacle – Provided in inches and millimeters

Dimensions are for reference only

### connector + plug

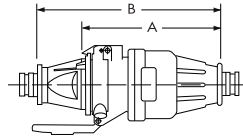

PRODUCT	A	B
	9.65	12.68
DX20/DX30	245	322
	16.06	21.14
DX60/DX100	408	537

### receptacle + plug

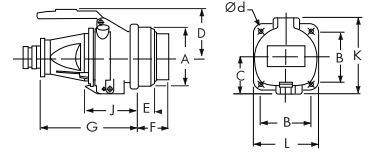

PRODUCT	A	B	C	D	E	F	G	J	K	L	Ød
	4.09	3.62	2.60	3.35	1.14	2.17	6.77	3.74	5.39	4.61	0.26
DX20/DX30	104	92	66	85	29	55	172	95	137	117	6.7
	5.83	4.80	3.62	4.33	1.06	3.54	11.89	6.81	7.28	6.30	0.35
DX60/DX100	148	122	92	110	27	90	302	173	185	160	9

### receptacle / box + plug

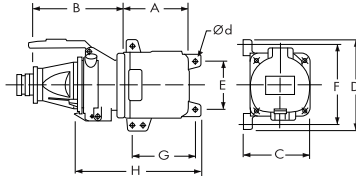

PRODUCT	A	B	C	D	E	F	G	H	Ød
	4.76	6.77	4.76	6.57	3.54	5.71	4.69	9.45	.35
DX20/DX30	121	172	121	167	90	145	119	240	9
	7.17	11.89	6.50	8.70	5.12	7.68	6.85	14.88	.39
DX60/DX100	182	302	165	221	130	195	174	378	10



# MULTIPIIN

Summary and Specifications	p. 90
PN12	p. 91
PN12 Stainless	p. 93
DSN24	p. 95
DS24 Stainless	p. 97
DSN37	p. 99
DS37 Stainless	p. 101
PN7	p. 103
DN9	p. 105
DN20	p. 107
DN7	p. 109
DS7	p. 111
DR7	p. 113



## Superior contact technology maximizes durability and performance

Meltric offers a broad range of multipin devices for use in a wide variety of control and power applications. Devices are available with as many as 37 or as few as 4 contacts. Products range from 2A up to 150A and some include load making and breaking capabilities.

### Main Advantages

- ▼ Spring-loaded, silver-nickel, butt-style contacts
- ▼ Robust casing materials made of fiberglass reinforced thermoplastic polyester, epoxy coated zamak, or stainless steel (depending on the model type and size).

# Product Features

## Product Line Summary

PN12 multipin plugs and receptacles are ideal for low amperage applications requiring compact devices. NEMA 4X/ IP66+67 watertightness provides protection in washdown environments.

PN7 plugs and receptacles are excellent for use when between 5 and 7 contacts are required with amperages up to 20A.

DSN 24/37 plugs and receptacles are excellent for frequent low ampacity connecting and disconnecting application. Up to 37 contacts are available on the device which is rated up to NEMA 4X/IP 66+67.

DN9 and DN20 devices allow multiple power circuits or a combination of power and control circuits in a single connection.

DN7, DR7, and DS7 multipins are excellent for those difficult, higher amperage environments where there is a need for frequent connecting and disconnecting. DS7 devices are current interrupting rated for up to 30 amps per contact, and like the DR7 allow the addition of up to 3 auxiliary contacts.



## Multipin Product Specifications

Product Type	Housing Material	Voltage (Max)	Number of Contacts		Amperage		Wiring Capacity		Environmental Rating	Wiring Connection	Catalog Page
			Min	Max	Current Interrupting	Non-Current Interrupting	Min	Max			
PN12**	Polyester	600	6	12	5	7.5	20 AWG	14 AWG	NEMA 4X/IP66 + 67	Solder	91
PN12**	Metal	600	6	12	5	7.5	20 AWG	14 AWG	NEMA 4X/IP66 + 67	Solder	91
PN12	Stainless	600	6	12	5	7.5	20 AWG	14 AWG	NEMA 1	Solder	93
DSN24	Polyester	480	13	24	2	7.5	20 AWG	14 AWG	NEMA 4X/IP66 + 67	Solder	95
DS24	Stainless	250	13	24	2	7.5	20 AWG	14 AWG	NEMA 3R	Solder	97
DSN37	Polyester	480	25	37	2	7.5	20 AWG	14 AWG	NEMA 4X/IP66 + 67	Solder	99
DS37	Stainless	480	13	37	2	7.5	20 AWG	14 AWG	NEMA 4X	Solder	101
PN7**	Polyester	600	5	7	15	20	18 AWG	10 AWG	NEMA 4X/IP66 + 67	Screw	103
PN7**	Metal	600	5	7	15	20	18 AWG	10 AWG	NEMA 4X/IP66 + 67	Screw	103
PN7	Stainless	600	5	7	15	20	18 AWG	10 AWG	NEMA 1	Screw	103
DN9	Metal	480	6	9	-	20	16 AWG	10 AWG	IP54/55+	Screw	105
DN20	Metal	480	10	20	-	20*	16 AWG	10 AWG	IP54/55+	Screw	107
DN7	Metal	480	6P+E	6P+E	-	50	10 AWG	6 AWG	IP54/55+	Screw	109
DN7	Metal	480	6P+E	6P+E	-	90	6 AWG	2 AWG	IP54/55+	Screw	109
DN7	Metal	480	6P+E	6P+E	-	150	6 AWG	2 AWG	IP54/55+	Screw	109
DS7	Polyester	600	4	7	30	-	14 AWG	8 AWG	IP54/55+	Screw	111
DS7	Metal	600	4	7	30	-	14 AWG	8 AWG	IP54/55+	Screw	111
DR7	Polyester	600	4	7	-	50	14 AWG	8 AWG	IP54/55+	Screw	113
DR7	Metal	600	4	7	-	50	14 AWG	8 AWG	IP54/55+	Screw	113

+ Rated IP54 when receptacle and plug are mated, when not mated receptacle alone is rated IP55 provided that the lid is latched closed.

\* The rating is reduced to 15A when more than 12 contacts are used for power circuits (not control)

\*\* UL 1682 Listed



# PN12 Multipin – 7.5A Plugs & Receptacles

## Ratings

- Voltage**  
50 VAC or 600 VAC Max
- Amperage Rating**  
5A Current Interrupting  
7.5A Non-Current Interrupting
- Environmental Ratings**  
NEMA 4X, IP66 + 67
- Temperature Range**  
Min -40°F/Max 140°F  
See pg 194 for temps below -15°F.
- Wiring Capacity**  
Min 20 AWG Max 14 AWG
- Listings**  
UL, CSA\*, IEC, CE\*  
\* Contact Customer Service  
\* Poly/metal versions only

For PN12 dimensions, see pgs 153-154

## Receptacle (female)



Don't forget to add installation accessories to your order

## Inlet (male)



Voltage	Polarity	Part #	
		Poly	Metal
50V	6P	01-M4060	09-M4060
50V	7P	01-M4070	09-M4070
50V	8P	01-M4080	09-M4080
50V	9P	01-M4090	09-M4090
50V	10P	01-M4100	09-M4100
50V	11P	01-M4110	09-M4110
50V	12P	01-M4120	09-M4120
600V	5P+E	01-M4051	09-M4051
600V	6P+E	01-M4061	09-M4061
600V	7P+E	01-M4071	09-M4071
600V	8P+E	01-M4081	09-M4081
600V	9P+E	01-M4091	09-M4091
600V	10P+E	01-M4101	09-M4101
600V	11P+E	01-M4111	09-M4111

Voltage	Polarity	Part #	
		Poly	Metal
50V	6P	01-M8060	09-M8060
50V	7P	01-M8070	09-M8070
50V	8P	01-M8080	09-M8080
50V	9P	01-M8090	09-M8090
50V	10P	01-M8100	09-M8100
50V	11P	01-M8110	09-M8110
50V	12P	01-M8120	09-M8120
600V	5P+E	01-M8051	09-M8051
600V	6P+E	01-M8061	09-M8061
600V	7P+E	01-M8071	09-M8071
600V	8P+E	01-M8081	09-M8081
600V	9P+E	01-M8091	09-M8091
600V	10P+E	01-M8101	09-M8101
600V	11P+E	01-M8111	09-M8111

## Main Options



## Receptacle Options

Option	Part #
Reverse Interiors	Recept # - 001
With Flush Mount	Recept # - 142
Locking Pawl	Recept # - 824-300

## Inlet Options

Option	Part #
Reverse Interiors	Inlet # - 001

See pgs 171-180 for detailed information on these options

**PN12 Order Example:**  
To order a device with a reverse interior add **-001** to the inlet and receptacle part numbers.

PN12 Inlet 5P+E 01-M4051-001

PN12 Receptacle 5P+E 01-M8051-001

Appropriate accessory part numbers must also be included on the order.

# Installation Accessories

Unless indicated otherwise, accessories can be used with either poly or metal plugs and receptacles

## Handles



NPT	Poly Handle Threaded Opening	Metal Handle* Threaded Opening	90° Nylon Handle Threaded Opening
1/2"	01-NA013-12	H091U12	04-2A090-5-12
3/4"	01-NA013-34	H091U34	04-2A090-5-34
1"	01-NA013-1	H091U1	04-2A090-5-10

Cable Range	Nylon Handle w/Clamp & Bushing	Angled Nylon Handle w/Clamp & Bushing
.27 - .75	01-NA013	-
.32 - .67	-	01-NA313

**Notes:** • For available cord grips, see pgs 167-168.  
\* For metal devices only

## NPT Guidelines

Cable Range	NPT
.062 - .5	1/2"
.187 - .75	3/4"
.437 - 1.10	1"
.750 - 1.375	1 1/4"

NPT sizes are determined by the cable diameter and third party cord grip.

## Junction Boxes

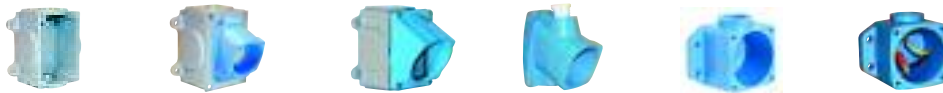

NPT	Metal Box	Metal Box Nylon Angle	Metal Box Metal Angle	Poly Conduit Entry	Poly Straight Wall Box	Metal Straight Wall Box
1/2"	MB312-601	01-NA053-080-12	09-NA053-080-12	01-NA023-12	01-NA025-12	09-NA025-12
3/4"	MB334-601	01-NA053-080-34	09-NA053-080-34	01-NA023-34	01-NA025-34	09-NA025-34
1"	MB31-601	01-NA053-080-1	09-NA053-080-1	-	-	-
1 1/4"	MB3114-601	01-NA053-080-114	09-NA053-080-114	-	-	-

## Angles

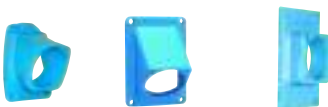

Nylon 30° Angle	Metal 45° Angle	Metal Straight Adapter
01-NA027	09-NA027	MSPN

## Miscellaneous Accessories



For Male Devices Only

Protective Cap	Flush Mount	Cord Grip with Mesh
01-NA126	01-2A142	see pgs 167-168

## Order Example

A typical order should include an inlet part number, a receptacle part number **AND** the matching handles, angles or other required accessories.



Male Inlet with Handle (Plug)  
09-M8090 + 01-NA313



Female Receptacle with Angle Adapter  
09-M4090 + 01-NA027



# PN12 Stainless Steel Multipin – 7.5A Plugs & Receptacles

## Ratings

- **Voltage**  
50 VAC or 600 VAC Max
- **Amperage Rating**  
5A Current Interrupting  
7.5A Non-Current Interrupting
- **Environmental Ratings**  
NEMA 1  
\* For additional sealing options,  
contact customer service
- **Temperature Range**  
Min -40°F/Max 140°F
- **Wiring Capacity**  
Min 20 AWG Max 14 AWG
- **Listings**  
UL, IEC, CE\*  
\* Contact Customer Service

For PN12 SS dimensions, contact  
Customer Service

## Receptacle (female)



Don't forget to  
add installation  
accessories to  
your order

## Inlet (male)



Voltage	Polarity	Part # Stainless Steel
50V	6P	09-14060-SS
50V	7P	09-14070-SS
50V	8P	09-14080-SS
50V	9P	09-14090-SS
50V	10P	09-14100-SS
50V	11P	09-14110-SS
50V	12P	09-14120-SS
600V	5P+E	09-14051-SS
600V	6P+E	09-14061-SS
600V	7P+E	09-14071-SS
600V	8P+E	09-14081-SS
600V	9P+E	09-14091-SS
600V	10P+E	09-14101-SS
600V	11P+E	09-14111-SS

Voltage	Polarity	Part # Stainless Steel
50V	6P	09-18060-SS
50V	7P	09-18070-SS
50V	8P	09-18080-SS
50V	9P	09-18090-SS
50V	10P	09-18100-SS
50V	11P	09-18110-SS
50V	12P	09-18120-SS
600V	5P+E	09-18051-SS
600V	6P+E	09-18061-SS
600V	7P+E	09-18071-SS
600V	8P+E	09-18081-SS
600V	9P+E	09-18091-SS
600V	10P+E	09-18101-SS
600V	11P+E	09-18111-SS

PN12 Stainless Steel Multipins are made of machined 304 Stainless Steel.



# Installation Accessories

## Handles



NPT	Stainless Steel Handle
1/2"	09-2A013-SS-12
3/4"	09-2A013-SS-34

## NPT Guidelines

Cable Range	NPT
.062 - .5	1/2"
.187 - .75	3/4"
.437 - 1.10	1"
.750 - 1.375	1 1/4"
.890 - 1.650	1 1/2"
1.125 - 2.438	2"
1.750 - 2.565	2 1/2"

NPT sizes are determined by the cable diameter and third party cord grip.

## Angles



Stainless Steel  
45° Angle

09-2A027-SS

*Notes:* • Includes angle adapter as shown.

## Junction Boxes



NPT	Stainless Steel Box with Stainless Steel Angle
3/4"	09-2A053-080-SS-34
1"	09-2A053-080-SS-1

## Order Example

A typical order should include an inlet part number, a receptacle part number **AND** the matching handles, angles or other required accessories.



Male Inlet with Handle (Plug)  
09-18090-SS + 09-2A013-SS-34



Female Receptacle with Angle Adapter  
09-14090-SS + 09-2A027-SS



# DSN 24 Multipin – 7.5A Plugs & Receptacles

## Ratings

- **Voltage**  
50 VAC or 480 VAC Max
- **Amperage Rating**  
2A Current Interrupting  
7.5A Non-Current Interrupting
- **Environmental Ratings**  
NEMA 4X, IP66 + 67
- **Temperature Range**  
Min -40°F/Max 140°F  
See pg 194 for temps below -15°F.
- **Wiring Capacity**  
Min 20 AWG Max 14 AWG
- **Listings**  
IEC, CE\*  
\* Contact Customer Service

For DSN24 dimensions, see pgs 31-32

## Receptacle (female)



 Don't forget to add installation accessories to your order

## Inlet (male)



Voltage	Polarity	Part # Poly
50V	13P	63-04130
50V	14P	63-04140
50V	15P	63-04150
50V	16P	63-04160
50V	17P	63-04170
50V	18P	63-04180
50V	19P	63-04190
50V	20P	63-04200
50V	21P	63-04210
50V	22P	63-04220
50V	23P	63-04230
50V	24P	63-04240
480V	12P+E	63-04121
480V	13P+E	63-04131
480V	14P+E	63-04141
480V	15P+E	63-04151
480V	16P+E	63-04161
480V	17P+E	63-04171
480V	18P+E	63-04181
480V	19P+E	63-04191
480V	20P+E	63-04201
480V	21P+E	63-04211
480V	22P+E	63-04221
480V	23P+E	63-04231

Voltage	Polarity	Part # Poly
50V	13P	63-08130
50V	14P	63-08140
50V	15P	63-08150
50V	16P	63-08160
50V	17P	63-08170
50V	18P	63-08180
50V	19P	63-08190
50V	20P	63-08200
50V	21P	63-08210
50V	22P	63-08220
50V	23P	63-08230
50V	24P	63-08240
480V	12P+E	63-08121
480V	13P+E	63-08131
480V	14P+E	63-08141
480V	15P+E	63-08151
480V	16P+E	63-08161
480V	17P+E	63-08171
480V	18P+E	63-08181
480V	19P+E	63-08191
480V	20P+E	63-08201
480V	21P+E	63-08211
480V	22P+E	63-08221
480V	23P+E	63-08231

## Main Options

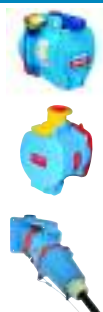

**Padlock Pawl**

**Emergency Stop Pawl**

**Self-Ejecting Devices\***

\* Requires straight insertion receptacle or inlet and self-ejecting plug or connector

## Receptacle Options

## Part #

Straight Insertion	Recept # - A188
Self-Ejecting Connector Release	Recept # - 345-A188
Emergency Stop Pawl	Recept # - 375
Padlock Pawl	Recept # - 843
Closed Lid Configuration	Recept # - NC



See pgs 171-180 for detailed information on these options

## Inlet Options

## Part #

Self-Ejecting Plug Release	Inlet # - 338-A188
Straight Insertion	Inlet # - A188
With No Lockout Hole	Inlet # - A155

### DSN24 Order Example:

To order a device with an Emergency Stop Pawl add **-375** to the receptacle part number

DSN24 22P = 63-04220-375

# Installation Accessories

## Handles



NPT	Poly Handle	Cable Range	Poly Handle w/Clamp & Bushing	Nylon Handle
1/2"	61-3A013-12	.20 - .83	–	61-3A013
3/4"	61-3A013-34	.750 - .875	1PM514	–
1"	61-3A013-1	.875 - 1.000	1PM516	–
1 1/4"	61-3A013-114	1.000 - 1.125	1PM518	–
		1.125 - 1.250	1PM520	–
		1.250 - 1.375	1PM522	–

**Notes:** • Finger draw plates are recommended for easier connector closure on cord to cord assemblies.

## NPT Guidelines

Cable Range	NPT
.062 - .5	1/2"
.187 - .75	3/4"
.437 - 1.10	1"
.750 - 1.375	1 1/4"

NPT sizes are determined by the cable diameter and third party cord grip.

## Angles



Nylon 30° Angle	Metal 30° Angle	Metal Angle FS/FD Box 30°	Metal Straight Adapter
61-3A027	MA2	MAFS2	MS2

## Junction Boxes



NPT	Metal Box	Metal Box with Nylon Angle	Poly* Conduit Entry
1/2"	MB312	61-3A053-080-12	61-3A023-12
3/4"	MB334	61-3A053-080-34	61-3A023-34
1"	MB31	61-3A053-080-1	–
1 1/4"	MB3114	61-3A053-080-114	–

\* For poly devices only

## Miscellaneous Accessories



Set of Two (2)



For Male Devices Only



For Male Devices Only



Finger Drawplates	Protective Cap	Padlockable Plug Cap	Cord Grip with Mesh
61-3A346	61-3A126	61-3A826	see pgs 167-168

## Accessory Spotlight

### Finger Drawplates



Finger drawplates are recommended for easier connector closure on cord to cord assemblies.

## Order Example

A typical order should include an inlet part number, a receptacle part number **AND** the matching handles, angles or other required accessories.



Male Inlet with Handle (Plug)  
63-08220 + 61-3A013

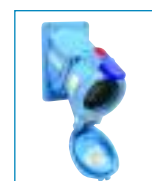

Female Receptacle with Angle Adapter  
63-04220 + 61-3A027





# DS24 Stainless Steel Multipin – 7.5A Plugs & Receptacles

## Ratings

- **Voltage**  
50 VAC or 250 VAC Max\*  
\* For 480V use DS37 devices
- **Amperage Rating**  
2A Current Interrupting  
7.5A Non-Current Interrupting
- **Environmental Ratings**  
NEMA 3R
- **Temperature Range**  
Min -40°F/Max 140°F
- **Wiring Capacity**  
Min 20 AWG Max 14 AWG
- **Listings**  
IEC, CE\*  
\* Contact Customer Service

For DS24 dimensions, see pgs 49-50

## Receptacle (female)



Don't forget to add installation accessories to your order

## Inlet (male)



Voltage	Polarity	Part # Stainless Steel
50V	13P	37-04130-SS
50V	14P	37-04140-SS
50V	15P	37-04150-SS
50V	16P	37-04160-SS
50V	17P	37-04170-SS
50V	18P	37-04180-SS
50V	19P	37-04190-SS
50V	20P	37-04200-SS
50V	21P	37-04210-SS
50V	22P	37-04220-SS
50V	23P	37-04230-SS
50V	24P	37-04240-SS
250V	12P+E	37-04121-SS
250V	13P+E	37-04131-SS
250V	14P+E	37-04141-SS
250V	15P+E	37-04151-SS
250V	16P+E	37-04161-SS
250V	17P+E	37-04171-SS
250V	18P+E	37-04181-SS
250V	19P+E	37-04191-SS
250V	20P+E	37-04201-SS
250V	21P+E	37-04211-SS
250V	22P+E	37-04221-SS
250V	23P+E	37-04231-SS

Voltage	Polarity	Part # Stainless Steel
50V	13P	37-08130-SS
50V	14P	37-08140-SS
50V	15P	37-08150-SS
50V	16P	37-08160-SS
50V	17P	37-08170-SS
50V	18P	37-08180-SS
50V	19P	37-08190-SS
50V	20P	37-08200-SS
50V	21P	37-08210-SS
50V	22P	37-08220-SS
50V	23P	37-08230-SS
50V	24P	37-08240-SS
250V	12P+E	37-08121-SS
250V	13P+E	37-08131-SS
250V	14P+E	37-08141-SS
250V	15P+E	37-08151-SS
250V	16P+E	37-08161-SS
250V	17P+E	37-08171-SS
250V	18P+E	37-08181-SS
250V	19P+E	37-08191-SS
250V	20P+E	37-08201-SS
250V	21P+E	37-08211-SS
250V	22P+E	37-08221-SS
250V	23P+E	37-08231-SS

# Installation Accessories

## Handles



NPT	Stainless Steel Handle
3/4"	1H34SS
1"	1H1SS

## NPT Guidelines

Cable Range	NPT
.062 - .5	1/2"
.187 - .75	3/4"
.437 - 1.10	1"
.750 - 1.375	1 1/4"
.890 - 1.650	1 1/2"
1.125 - 2.438	2"
1.750 - 2.565	2 1/2"

NPT sizes are determined by the cable diameter and third party cord grip.

## Angles



Stainless Steel 30° Angle
MA2SS

## Junction Boxes



NPT	Stainless Steel Box with Stainless Steel Angle	Stainless Steel Box
1	39-1A053-080-SS-1	MB31SS

## Order Example

A typical order should include an inlet part number, a receptacle part number **AND** the matching handles, angles or other required accessories.



**Male Inlet with Handle (Plug)**  
37-08130-SS + 1H1SS



**Female Receptacle with Angle Adapter**  
37-04130-SS + MA2SS



# DSN 37 Multipin – 7.5A Plugs & Receptacles

### Ratings

- Voltage**  
50 VAC or 480 VAC Max
- Amperage Rating**  
2A Current Interrupting  
7.5A Non-Current Interrupting
- Environmental Ratings**  
NEMA 4X, IP66 + 67
- Temperature Range**  
Min -40°F/Max 140°F  
See pg 194 for temps below -15°F.
- Wiring Capacity**  
Min 20 AWG Max 14 AWG
- Listings**  
IEC, CE\*  
\* Contact Customer Service

For DSN37 dimensions, see pgs 31-32

### Receptacle (female)



Don't forget to add installation accessories to your order

Voltage	Polarity	Part # Poly
50V	25P	63-04250
50V	26P	63-04260
50V	27P	63-04270
50V	28P	63-04280
50V	29P	63-04290
50V	30P	63-04300
50V	31P	63-04310
50V	32P	63-04320
50V	33P	63-04330
50V	34P	63-04340
50V	35P	63-04350
50V	36P	63-04360
50V	37P	63-04370
480V	24P+E	63-04241
480V	25P+E	63-04251
480V	26P+E	63-04261
480V	27P+E	63-04271
480V	28P+E	63-04281
480V	29P+E	63-04291
480V	30P+E	63-04301
480V	31P+E	63-04311
480V	32P+E	63-04321
480V	33P+E	63-04331
480V	34P+E	63-04341
480V	35P+E	63-04351
480V	36P+E	63-04361

### Inlet (male)



Voltage	Polarity	Part # Poly
50V	25P	63-08250
50V	26P	63-08260
50V	27P	63-08270
50V	28P	63-08280
50V	29P	63-08290
50V	30P	63-08300
50V	31P	63-08310
50V	32P	63-08320
50V	33P	63-08330
50V	34P	63-08340
50V	35P	63-08350
50V	36P	63-08360
50V	37P	63-08370
480V	24P+E	63-08241
480V	25P+E	63-08251
480V	26P+E	63-08261
480V	27P+E	63-08271
480V	28P+E	63-08281
480V	29P+E	63-08291
480V	30P+E	63-08301
480V	31P+E	63-08311
480V	32P+E	63-08321
480V	33P+E	63-08331
480V	34P+E	63-08341
480V	35P+E	63-08351
480V	36P+E	63-08361

### Main Options

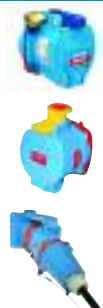

**Padlock Pawl**

**Emergency Stop Pawl**

**Self-Ejecting Devices\***

\* Requires straight insertion receptacle or inlet and self-ejecting plug or connector

### Receptacle Options

Option	Part #
Straight Insertion	Recept # - A188
Self-Ejecting Connector Release	Recept # - 345-A188
Emergency Stop Pawl	Recept # - 375
Padlock Pawl	Recept # - 843
Closed Lid Configuration	Recept # - NC

See pgs 171-180 for detailed information on these options

### Inlet Options

Option	Part #
Self-Ejecting Plug Release	Inlet # - 338-A188
Straight Insertion	Inlet # - A188
With No Lockout Hole	Inlet # - A155

**DSN37 Order Example:**  
To order a device with an Emergency Stop Pawl add **-375** to the receptacle part number  
DSN37 32P = 63-04320-375

# Installation Accessories

## Handles



Makes connector closures easier

NPT	Poly Handle	Cable Range	Poly Handle w/Clamp & Bushing	Nylon Handle	Poly Handle w/built in Draw Grips
1/2"	61-6A013-12	.32 - 1.25	-	-	61-6A473
3/4"	61-6A013-34	.39 - 1.18	-	61-6A013	-
1"	61-6A013-1	.750 - .875	3PM514	-	-
1 1/4"	61-6A013-114	.875 - 1.000	3PM516	-	-
		1.000 - 1.125	3PM518	-	-
		1.125 - 1.250	3PM520	-	-
		1.250 - 1.375	3PM522	-	-

**Notes:** • Finger draw plates are recommended for easier connector closure on cord to cord assemblies.

## NPT Guidelines

Cable Range	NPT
.062 - .5	1/2"
.187 - .75	3/4"
.437 - 1.10	1"
.750 - 1.375	1 1/4"

NPT sizes are determined by the cable diameter and third party cord grip.

## Angles



Nylon 30° Angle	Metal 30° Angle	Metal 70° Angle	Metal Angle FS/FD Box 30°	Metal Straight Adapter
61-6A027	MA3	89-3A027	MAFS3	MS3

## Junction Boxes



NPT	Metal Box	Metal Box with Nylon Angle	Poly* Conduit Entry
1/2"	MB312	61-6A053-080-12	61-6A023-12
3/4"	MB334	61-6A053-080-34	61-6A023-34
1"	MB31	61-6A053-080-1	61-6A023-1
1 1/4"	MB3114	61-6A053-080-114	-

\* For poly devices only

## Miscellaneous Accessories



\* Set of Two (2)



For Male Devices Only



For Male Devices Only



Finger Drawplates	Protective Cap	Padlockable Plug Cap	Cord Grip with Mesh
61-6A346	61-6A126	61-6A826	see pgs 167-168

\* Recommended for cord to cord assembly applications, for easier connector closure

## Order Example

A typical order should include an inlet part number, a receptacle part number **AND** the matching handles, angles or other required accessories.



Male Inlet with Handle (Plug)  
63-08340 + 61-6A013



Female Receptacle with Angle Adapter  
63-04340 + 61-6A027



# DS37 Stainless Steel Multipin – 7.5A Plugs & Receptacles

### Ratings

- **Voltage**  
50 VAC or 480 VAC Max
- **Amperage Rating**  
2A Current Interrupting  
7.5A Non-Current Interrupting
- **Environmental Ratings**  
NEMA 4X
- **Temperature Range**  
Min -40°F/Max 140°F
- **Wiring Capacity**  
Min 20 AWG Max 14 AWG
- **Listings**  
IEC, CE\*  
\* Contact Customer Service

For DS37 dimensions, see pgs 49-50

### Receptacle (female)



Don't forget to add installation accessories to your order

### Inlet (male)



Voltage	Polarity	Part # Stainless Steel
50V	25P	37-04250-SS
50V	26P	37-04260-SS
50V	27P	37-04270-SS
50V	28P	37-04280-SS
50V	29P	37-04290-SS
50V	30P	37-04300-SS
50V	31P	37-04310-SS
50V	32P	37-04320-SS
50V	33P	37-04330-SS
50V	34P	37-04340-SS
50V	35P	37-04350-SS
50V	36P	37-04360-SS
50V	37P	37-04370-SS
480V	24P+E	37-04241-SS
480V	25P+E	37-04251-SS
480V	26P+E	37-04261-SS
480V	27P+E	37-04271-SS
480V	28P+E	37-04281-SS
480V	29P+E	37-04291-SS
480V	30P+E	37-04301-SS
480V	31P+E	37-04311-SS
480V	32P+E	37-04321-SS
480V	33P+E	37-04331-SS
480V	34P+E	37-04341-SS
480V	35P+E	37-04351-SS
480V	36P+E	37-04361-SS

Voltage	Polarity	Part # Stainless Steel
50V	25P	37-08250-SS
50V	26P	37-08260-SS
50V	27P	37-08270-SS
50V	28P	37-08280-SS
50V	29P	37-08290-SS
50V	30P	37-08300-SS
50V	31P	37-08310-SS
50V	32P	37-08320-SS
50V	33P	37-08330-SS
50V	34P	37-08340-SS
50V	35P	37-08350-SS
50V	36P	37-08360-SS
50V	37P	37-08370-SS
480V	24P+E	37-08241-SS
480V	25P+E	37-08251-SS
480V	26P+E	37-08261-SS
480V	27P+E	37-08271-SS
480V	28P+E	37-08281-SS
480V	29P+E	37-08291-SS
480V	30P+E	37-08301-SS
480V	31P+E	37-08311-SS
480V	32P+E	37-08321-SS
480V	33P+E	37-08331-SS
480V	34P+E	37-08341-SS
480V	35P+E	37-08351-SS
480V	36P+E	37-08361-SS

# Installation Accessories

## Handles



NPT	Stainless Steel Handle
3/4"	3H34SS
1"	3H1SS
1 1/4"	3H114SS

## NPT Guidelines

Cable Range	NPT
.187 - .75	3/4"
.437 - 1.10	1"
.750 - 1.375	1 1/4"

NPT sizes are determined by the cable diameter and third party cord grip.

## Angles



Stainless Steel  
30° Angle

MA3SS

*Notes:* • Includes angle adapter as shown.

## Junction Boxes



NPT	Stainless Steel Box with Stainless Steel Angle	Stainless Steel Box
1	39-3A053-080-SS-1	MB31SS

## Order Example

A typical order should include an inlet part number, a receptacle part number **AND** the matching handles, angles or other required accessories.



Male Inlet with Handle (Plug)  
37-08320-SS + 3H1SS



Female Receptacle with Angle Adapter  
37-04320-SS + MA3SS



# PN7 Poly/Stainless Steel Multipin – 20A Plugs & Receptacles

## Ratings

- Voltage**  
50 VAC or 600 VAC Max
- Amperage Rating**  
15A Current Interrupting  
20A Non-Current Interrupting
- Environmental Ratings**  
NEMA 4X, IP66 + 67\*  
\* Stainless PN7 are NEMA 1
- Temperature Range**  
Min -40°F/Max 140°F  
See pg 194 for temps below -15°F.
- Wiring Capacity**  
Min 18 AWG Max 10 AWG
- Listings**  
UL, CSA+, IEC, CE\*  
\* Contact Customer Service  
\* Poly/metal versions only

For PN7 dimensions, see pgs 153-154

## Receptacle (female)



Don't forget to add installation accessories to your order

Voltage	Polarity	Poly	Part #	
			Metal	Stainless Steel
50V	5P	01-P4050	09-P4050	09-04050-SS
50V	6P	01-P4060	09-P4060	09-04060-SS
50V	7P	01-P4070	09-P4070	09-04070-SS
600V	4P+E	01-P4041	09-P4041	09-04041-SS
600V	5P+E	01-P4051	09-P4051	09-04051-SS
600V	6P+E	01-P4061	09-P4061	09-04061-SS

## Inlet (male)



Voltage	Polarity	Poly	Part #	
			Metal	Stainless Steel
50V	5P	01-P8050	09-P8050	09-08050-SS
50V	6P	01-P8060	09-P8060	09-08060-SS
50V	7P	01-P8070	09-P8070	09-08070-SS
600V	4P+E	01-P8041	09-P8041	09-08041-SS
600V	5P+E	01-P8051	09-P8051	09-08051-SS
600V	6P+E	01-P8061	09-P8061	09-08061-SS

## Main Options



Reverse Interiors



Flush Mount



Locking Pawl

See pgs 171-180 for detailed information on these options

## Receptacle Options

## Part #

Reverse Interiors	Recept # - 001
With Flush Mount	Recept # - 142
Locking Pawl	Recept # - 824-300

## Inlet Options

## Part #

Reverse Interiors	Inlet # - 001
-------------------	---------------

### PN7 Order Example:

To order a device with a reverse interior add **-001** to the inlet and receptacle part numbers.

PN7 Inlet 5P+E 01-P4051-**001**

PN7 Receptacle 5P+E 01-P8051-**001**

Appropriate accessory part numbers must also be included on the order.

# Installation Accessories

Unless indicated otherwise, accessories can be used with either poly or metal plugs and receptacles

## Handles



NPT	Poly Handle Threaded Opening	Metal Handle* Threaded Opening	90° Nylon Handle Threaded Opening	Stainless Steel Handle
1/2"	01-NA013-12	H091U12	04-2A090-5-12	-
3/4"	01-NA013-34	H091U34	04-2A090-5-34	09-2A013-SS-34
1"	01-NA013-1	H091U1	04-2A090-5-10	

Cable Range	Nylon Handle w/Clamp & Bushing	Angled Nylon Handle w/Clamp & Bushing
.27 - .75	01-NA013	-
.32 - .67	-	01-NA313

**Notes:** • For available cord grips, see pgs 167-168.  
\* For metal devices only

## NPT Guidelines

Cable Range	NPT
.062 - .5	1/2"
.187 - .75	3/4"
.437 - 1.10	1"
.750 - 1.375	1 1/4"

NPT sizes are determined by the cable diameter and third party cord grip.

## Junction Boxes

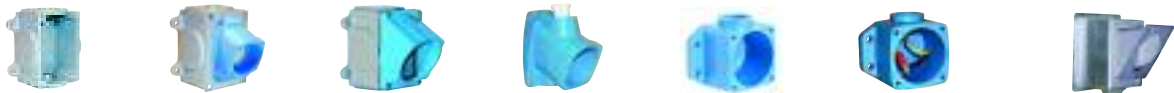

NPT	Metal Box	Metal Box with Nylon Angle	Metal Box with Metal Angle	Poly Conduit Entry	Poly Straight Wall Box	Metal Straight Wall Box	Stainless Steel Angle with Stainless Steel Box
1/2"	MB312-601	01-NA053-080-12	09-NA053-080-12	01-NA023-12	01-NA025-12	09-NA025-12	-
3/4"	MB334-601	01-NA053-080-34	09-NA053-080-34	01-NA023-34	01-NA025-34	09-NA025-34	-
1"	MB31-601	01-NA053-080-1	09-NA053-080-1	-	-	-	09-2A053-080-SS-1
1 1/4"	MB3114-601	01-NA053-080-114	09-NA053-080-114	-	-	-	-

## Angles



Nylon 30° Angle	Metal 45° Angle	Metal Straight Adapter	Stainless Steel 45° Angle
01-NA027	09-NA027	MSPN	09-2A027-SS

## Miscellaneous Accessories



For Male Devices Only

Protective Cap	Flush Mount	Cord Grip with Mesh
01-NA126	01-2A142	see pgs 167-168

## Order Example

A typical order should include an inlet part number, a receptacle part number **AND** the matching handles, angles or other required accessories.



Male Inlet with Handle (Plug)  
09-P8070 + 01-NA313



Female Receptacle with Angle Adapter  
09-P4070 + 01-NA027





# DN9 Multipin – 20A Plugs & Receptacles

### Ratings

- **Voltage**  
50 VAC or 480 VAC Max
- **Amperage Rating**  
20A Non-Current Interrupting
- **Environmental Ratings**  
IP54/55
- **Temperature Range**  
Min -40°F/Max 140°F  
See pg 194 for temps below -15°F.
- **Wiring Capacity**  
Min 16 AWG Max 10 AWG
- **Listings**  
Contact Customer Service

### Receptacle (female)



Don't forget to add installation accessories to your order

### Inlet (male)



Voltage	Polarity	Part # Metal
50V	6P	19-14060
50V	7P	19-14070
50V	8P	19-14080
50V	9P	19-14090
480V	5P+E	19-14051
480V	6P+E	19-14061
480V	7P+E	19-14071
480V	8P+E	19-14081

Voltage	Polarity	Part # Metal
50V	6P	19-18060
50V	7P	19-18070
50V	8P	19-18080
50V	9P	19-18090
480V	5P+E	19-18051
480V	6P+E	19-18061
480V	7P+E	19-18071
480V	8P+E	19-18081

### Main Options

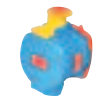

**Emergency Stop Pawl**



**Padlock Pawl**



**Self-Ejecting Devices**

\* Requires straight insertion receptacle or inlet and self-ejecting plug or connector

### Receptacle Options

### Part #

Straight Insertion	Recept # - A188
Self-Ejecting Connector Release	Recept # - 348-A188
HP Watertightness (high pressure)	Recept # - HP
Emergency Stop Pawl	Recept # - 375
Locking Mushroom Pawl	Recept # - 845
Padlock Pawl	Recept # - 843
Closed Lid Configuration	Recept # - NC

### Inlet Options

### Part #

Self-Ejecting Plug Release	Inlet # - 338-A188
Straight Insertion	Inlet # - A188

See pgs 171-180 for detailed information on these options

#### DN9 Order Example:

To order Closed Lid Configuration on a receptacle add **-NC** to the part numbers.

DN9 Receptacle 9P=19-14090-**NC**

Appropriate accessory part numbers must also be included on the order.

# Installation Accessories

Unless indicated otherwise, accessories can be used with either poly or metal plugs and receptacles

## Handles



NPT	Poly Handle	Metal* Handle	Cable Range	Poly Handle w/Clamp & Bushing	Nylon Handle	Neoprene Handle	Poly Handle w/built in Draw Grips
1/2"	3PH12	3H12	.32 - 1.25	-	-	-	FH311-473
3/4"	3PH34	3H34	.38 - 1.12	-	-	31-311	-
1"	3PH1	3H1	.39 - 1.18	-	FH311	-	-
1 1/4"	3PH114	3H114	.750 - .875	3PM514	-	-	-
			.875 - 1.000	3PM516	-	-	-
			1.000 - 1.125	3PM518	-	-	-
			1.125 - 1.250	3PM520	-	-	-
			1.250 - 1.375	3PM522	-	-	-

Not NEMA 3R

Makes connector closures easier

- Notes:**
- Finger draw plates are recommended for easier connector closure on cord to cord assemblies.
  - For available cord grips, see pgs 167-168.
  - \* For metal devices only

## NPT Guidelines

Cable Range	NPT
.062 - .5	1/2"
.187 - .75	3/4"
.437 - 1.10	1"
.750 - 1.375	1 1/4"

NPT sizes are determined by the cable diameter and third party cord grip.

## Angles



Metal 30° Angle	Metal 70° Angle	Metal Angle FS/FD Box 30°	Metal Straight Adapter
MA3	89-3A027	MAFS3	MS3

## Junction Boxes



NPT	Metal Box	Metal Box Metal Angle 30°
1/2"	MB312	39-3A053-080-12
3/4"	MB334	39-3A053-080-34
1"	MB31	39-3A053-080-1
1 1/4"	MB3114	39-3A053-080-114

## Miscellaneous Accessories



\* Set of Two (2)

For Male Devices Only

Finger Drawplates	Protective Neoprene Cap	Cord Grip with Mesh
FDP3	DN16R	see pgs 167-168

\* Recommended for cord to cord assembly applications, for easier connector closure

## Order Example

A typical order should include an inlet part number, a receptacle part number **AND** the matching handles, angles or other required accessories.

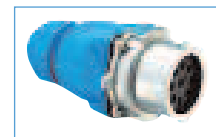

Male Inlet with Handle (Plug)  
19-18060 + FH311



Female Receptacle with Angle Adapter  
19-14060 + MA3

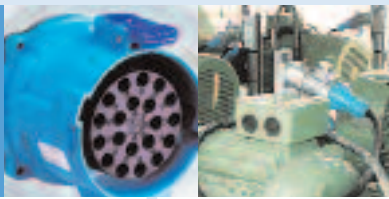

## DN20 Multipin – 20A Plugs & Receptacles

### Ratings

- Voltage**  
50 VAC or 480 VAC Max
- Amperage Rating**  
20A Non-Current Interrupting\*  
\* The amperage rating is 15A when more than 12 contacts are used for power circuits (not control).
- Environmental Ratings**  
IP54/55
- Temperature Range**  
Min -40°F/Max 140°F  
See pg 194 for temps below -15°F.
- Wiring Capacity**  
Min 16 AWG Max 10 AWG
- Listings**  
Contact Customer Service

### Receptacle (female)



Don't forget to add installation accessories to your order

### Inlet (male)



Voltage	Polarity	Part # Metal
50V	10P	19-64100
50V	11P	19-64110
50V	12P	19-64120
50V	13P	19-64130*
50V	14P	19-64140*
50V	15P	19-64150*
50V	16P	19-64160*
50V	17P	19-64170*
50V	18P	19-64180*
50V	19P	19-64190*
50V	20P	19-64200*
480V	9P+E	19-64091
480V	10P+E	19-64101
480V	11P+E	19-64111
480V	12P+E	19-64121
480V	13P+E	19-64131*
480V	14P+E	19-64141*
480V	15P+E	19-64151*
480V	16P+E	19-64161*
480V	17P+E	19-64171*
480V	18P+E	19-64181*
480V	19P+E	19-64191*

Voltage	Polarity	Part # Metal
50V	10P	19-68100
50V	11P	19-68110
50V	12P	19-68120
50V	13P	19-68130*
50V	14P	19-68140*
50V	15P	19-68150*
50V	16P	19-68160*
50V	17P	19-68170*
50V	18P	19-68180*
50V	19P	19-68190*
50V	20P	19-68200*
480V	9P+E	19-68091
480V	10P+E	19-68101
480V	11P+E	19-68111
480V	12P+E	19-68121
480V	13P+E	19-68131*
480V	14P+E	19-68141*
480V	15P+E	19-68151*
480V	16P+E	19-68161*
480V	17P+E	19-68171*
480V	18P+E	19-68181*
480V	19P+E	19-68191*

### Main Options

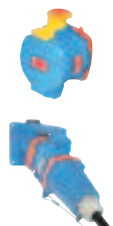

**Emergency Stop Pawl**

**Self-Ejecting Devices**

\* Requires straight insertion receptacle or inlet and self-ejecting plug or connector

See pgs 171-180 for detailed information on these options

### Receptacle Options

### Part #

Straight Insertion	Recept # - A188
Self-Ejecting Connector Release	Recept # - 348-A188
HP Watertightness (high pressure)	Recept # - HP
Emergency Stop Pawl	Recept # - 375
Locking Mushroom Pawl	Recept # - 845
Padlock Pawl	Recept # - 843
Closed Lid Configuration	Recept # - NC

### Inlet Options

### Part #

Self-Ejecting Plug Release	Inlet # - 338-A188
Straight Insertion	Inlet # - A188

#### DN20 Order Example:

To order Closed Lid Configuration on a receptacle add **-NC** to the receptacle part numbers.

DN20 Receptacle 19P=19-64190-NC

Appropriate accessory part numbers must also be included on the order.

# Installation Accessories

Unless indicated otherwise, accessories can be used with either poly or metal plugs and receptacles

## Handles

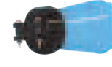

IP 66/67

NPT	Poly Handle	Metal* Handle
3/4"	9PH34	9H34
1"	9PH1	9H1
1 1/4"	9PH114	9H114
1 1/2"	9PH112	9H112
2"	9PH2	9H2

Cable Range	Poly Handle w/Clamp & Bushing	Santoprene™ Handle
.70 - 1.00	–	65-9A013-D25
1.00 - 1.375	–	65-9A013-D35
1.250 - 1.375	9PM622	–
1.375 - 1.750	–	65-9A013-D45
1.438 - 1.562	9PM625	–
1.562 - 1.688	9PM627	–
1.688 - 1.812	9PM629	–

**Notes:** • For available cord grips, see pgs 167-168.  
\* For metal devices only

## NPT Guidelines

## Angles



Metal 30° Angle	Metal 70° Angle	Metal Straight Adapter
MA10	89-9A027	MS10

## Junction Boxes

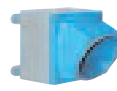

NPT	Metal Box	Metal Box Metal Angle 30°
1 1/4"	MB10114	39-9A053-080-114
1 1/2"	MB10112	39-9A053-080-112
2"	MB102	39-9A053-080-2
2 1/2"	MB10212	39-9A053-080-212

Cable Range	NPT
.062 - .5	1/2"
.187 - .75	3/4"
.437 - 1.10	1"
.750 - 1.375	1 1/4"
.890 - 1.650	1 1/2"
1.125 - 2.438	2"
1.750 - 2.565	2 1/2"

NPT sizes are determined by the cable diameter and third party cord grip.

## Miscellaneous Accessories



For Male Devices Only



Protective Neoprene Cap	Removable Draw Bar Complete Kit *	1 Draw Bar	1 Plate	Permanently Attached Complete Kit **	1 Draw Bar 1 Attached Plate	1 Plate
DN63R	NT100	NT110	NT120	39-9A486	39-9A024-486	39-9A014-486

\* Consists of 1 Draw Bar and 2 Plates

\*\* Consists of 1 Draw Bar with Attached Plate and 1 additional Plate

## Order Example

A typical order should include an inlet part number, a receptacle part number **AND** the matching handles, angles or other required accessories.



Male Inlet with Handle (Plug)  
19-68200 + 65-9A013-D25



Female Receptacle with Angle Adapter  
19-64200 + MA10



# DN7 Multipin – 50-150A Plugs & Receptacles

### Ratings

- Voltage**  
480 VAC Max
- Amperage Rating**  
50A Non-Current Interrupting  
90A Non-Current Interrupting  
150A Non-Current Interrupting
- Environmental Ratings**  
IP54/55
- Temperature Range**  
Min -40°F/Max 140°F  
See pg 194 for temps below -15°F.
- Wiring Capacity**  
50A Min 10 AWG Max 6 AWG  
90A Min 6 AWG Max 2 AWG  
150A Min 6 AWG max 2 AWG
- Listings**  
Contact Customer Service

### Receptacle (female)



Don't forget to add installation accessories to your order

### Inlet (male)



Voltage	Polarity	Amperage	Part # Metal
480V	6P+E	50A	19-34061
480V	6P+E	90A	19-64061
480V	6P+E	150A	39-94061

Voltage	Polarity	Amperage	Part # Metal
480V	6P+E	50A	19-38061
480V	6P+E	90A	19-68061
480V	6P+E	150A	39-98061

### Main Options



**Emergency Stop Pawl**



**Padlock Pawl**

### Receptacle Options

### Part #

HP Watertightness (high pressure)	Recept # - HP
Emergency Stop Pawl	Recept # - 375
Locking Mushroom Pawl	Recept # - 845
Padlock Pawl	Recept # - 843
Closed Lid Configuration	Recept # - NC

### Inlet Options

### Part #

With No Lockout Hole	Inlet # - A155
----------------------	----------------

#### DN7 Order Example:

To order a device with an Emergency Stop Pawl add **-375** to the receptacle part number

DN7 90A = 19-64061-375

See pgs 171-180 for detailed information on these options

## Installation Accessories

### Miscellaneous Accessories



\* Set of Two (2)



For Male Devices Only



Amp	Finger Drawplates	Protective Neoprene Cap	Removable Draw Bar Complete Kit **	1 Draw Bar	1 Plate	Permanently Attached Complete Kit ***	1 Draw Bar 1 Attached Plate	1 Plate
50A	FDP6	-	-	-	-	-	-	-
90A	-	DN63R	NT100	NT110	NT120	39-9A486	39-9A024-486	39-9A014-486
150A	-	31-2A126	NT200	NT210	NT220	39-2A486	39-2A024-486	39-2A014-486

\* Recommended for cord to cord assembly applications, for easier connector closure

\*\* Consists of 1 Draw Bar and 2 Plates

\*\*\* Consists of 1 Draw Bar with Attached Plate and 1 additional Plate

# Installation Accessories

Unless indicated otherwise, accessories can be used with either poly or metal plugs and receptacles

## Handles



NPT	Poly Handle			Metal Handle*		
	50A	90A	150A	50A	90A	150A
1/2"	6PH12	-	-	6H12	-	-
3/4"	6PH34	9PH34	-	6H34	9H34	-
1"	6PH1	9PH1	-	6H1	9H1	2H1
1 1/4"	6PH114	9PH114	-	6H114	9H114	2H114
1 1/2"	6PH112	9PH112	2PH112	6H112	9H112	2H112
2"	-	9PH2	2PH2	-	9H2	2H2
2 1/2"	-	-	2PH212	-	-	2H212



Not NEMA 3R

IP 66/67

Makes connector closures easier

Cable Range	Poly Handle w/Clamp & Bushing		Nylon Handle 50A	Neoprene Handle	Santoprene™ Handle	Poly Handle w/built in Draw Grips 50A
	50A	90A				
.50 - 1.25	-	-	-	31-611 (50A)	-	-
.51 - 1.38	-	-	FH611	-	-	FH611-473 (50A)
.70 - 1.00	-	-	-	-	65-9A013-D25	-
1.00 - 1.375	-	-	-	-	65-9A013-D35	-
1.250 - 1.375	6PM622	9PM622	-	-	-	-
1.375 - 1.750	-	-	-	-	65-9A013-D45	-
1.438 - 1.562	6PM625	9PM625	-	-	-	-
1.500 - 2.250	-	-	-	31-211 (150A)	-	-
1.562 - 1.688	6PM627	9PM627	-	-	-	-
1.688 - 1.812	6PM629	9PM629	-	-	-	-

**Notes:** • Finger draw plates are recommended for easier connector closure on cord to cord assemblies.  
 • For available cord grips, see pgs 167-168.  
 \* For metal devices only

• For a guideline of NPT sizes based on cable ranges, see DN20 pg 108.

## Angles



Amp	Metal 30° Angle	Metal 70° Angle	Metal Angle Oversized 30°	Metal Angle Oversized 45°	Metal Straight Adapter	Metal Lateral Angle 30°
50A	MA6	89-6A027	MA660	-	MS6	MAB6
90A	MA10	89-9A027	MA110	-	MS10	-
150A	MA20	-	-	MA220	MS20	-

## Junction Boxes

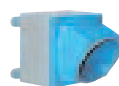

NPT	Metal Box			Metal Box with Metal Angle 30°		
	50A	90A	150A	50A	90A	150A
1"	MB61	-	-	39-6A053-080-1	-	-
1 1/4"	MB6114	MB10114	-	39-6A053-080-114	39-9A053-080-114	-
1 1/2"	MB6112	MB10112	MB20112	39-6A053-080-112	39-9A053-080-112	39-2A053-080-112
2"	MB62	MB102	MB202	39-6A053-080-2	39-9A053-080-2	39-2A053-080-2
2 1/2"	-	MB10212	MB20212	-	39-9A053-080-212	39-2A053-080-212
Oversized	-	-	MB22212	-	-	39-2A053-080-2210

## Order Example

A typical order should include an inlet part number, a receptacle part number **AND** the matching handles, angles or other required accessories.



Male Inlet with Handle (Plug)  
19-38061 + 6PH34

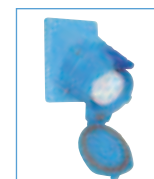

Female Receptacle with Angle Adapter  
19-34061 + MA6



## DS7 Multipin – 30A Plugs & Receptacles

### Ratings

- **Voltage**  
50 VAC or 600 VAC Max
- **Amperage Rating**  
30A Current Interrupting
- **Environmental Ratings**  
IP54/55
- **Temperature Range**  
Min -40°F/Max 140°F  
See pg 194 for temps below -15°F.
- **Wiring Capacity**  
Min 14 AWG Max 8 AWG
- **Listings**  
Contact Customer Service

For DS7 dimensions, see pgs 49-50

### Receptacle (female)



### Inlet (male)



Voltage	Polarity	Part #	
		Poly	Metal
50V	4P	33-34540	37-34540
50V	5P	33-34550	37-34550
50V	6P	33-34560	37-34560
50V	7P	33-34570	37-34570
600V	3P+E	33-34531	37-34531
600V	4P+E	33-34541	37-34541
600V	5P+E	33-34551	37-34551
600V	6P+E	33-34561	37-34561

Voltage	Polarity	Part #	
		Poly	Metal
50V	4P	33-38540	37-38540
50V	5P	33-38550	37-38550
50V	6P	33-38560	37-38560
50V	7P	33-38570	37-38570
600V	3P+E	33-38531	37-38531
600V	4P+E	33-38541	37-38541
600V	5P+E	33-38551	37-38551
600V	6P+E	33-38561	37-38561

### Main Options



**Padlock Pawl**



**Emergency Stop Pawl**



**Self-Ejecting Devices**

\* Requires straight insertion receptacle or inlet and self-ejecting plug or connector

### Receptacle Options

### Part #

With 2 Auxiliary/Pilot contacts	Recept # - 172
With 3 Auxiliary/Pilot contacts	Recept # - 173
LP Watertightness (low pressure)	Recept # - LP
HP Watertightness (high pressure)	Recept # - HP
Straight Insertion	Recept # - A188
Self-Ejecting Connector Release	Recept # - 348-A188
Emergency Stop Pawl	Recept # - 375
Locking Mushroom Pawl	Recept # - 845
Padlock Pawl	Recept # - 843
Metal Pawl (on poly receptacle)	Recept # - 824
180° Opening Lid	Recept # - 180
Closed Lid Configuration	Recept # - NC
Recess Plate	Recept # - 142

### Inlet Options

### Part #

With 2 Auxiliary/Pilot Contacts	Inlet # - 172
With 3 Auxiliary/Pilot Contacts	Inlet # - 173
LP Watertightness (low pressure)	Inlet # - LP
HP Watertightness (high pressure)	Inlet # - HP
Self-Ejecting Plug Release	Inlet # - 338-A188
Straight Insertion	Inlet # - A188
With No Lockout Hole	Inlet # - A155

See pgs 171-180 for detailed information on these options

#### DS7 Order Example:

To order a device with an Emergency Stop Pawl add **-375** to the receptacle part number  
DS7 4P = 33-38540-375

# Installation Accessories

Unless indicated otherwise, accessories can be used with either poly or metal plugs and receptacles

## Handles



NPT	Poly Handle	Metal* Handle	Cable Range	Poly Handle w/Clamp & Bushing	Nylon Handle	Neoprene Handle	Poly Handle w/built in Draw Grips
1/2"	6PH12	6H12	.50 - 1.25	-	-	31-611	-
3/4"	6PH34	6H34	.51 - 1.38	-	FH611	-	FH611-473
1"	6PH1	6H1	1.250 - 1.375	6PM622	-	-	-
1 1/4"	6PH114	6H114	1.438 - 1.562	6PM625	-	-	-
1 1/2"	6PH112	6H112	1.562 - 1.688	6PM627	-	-	-
			1.688 - 1.812	6PM629	-	-	-

- Notes:**
- Finger draw plates are recommended for easier connector closure on cord to cord assemblies.
  - For available cord grips, see pgs 167-168.
  - \* For metal devices only

## Angles



Nylon 30° Angle	Metal 30° Angle	Metal 70° Angle	Metal Angle Oversized 30°	Metal Straight Adapter	Metal Lateral Angle 30°
MP6	MA6	89-6A027	MA660	MS6	MAB6

## NPT Guidelines

Cable Range	NPT
.062 - .5	1/2"
.187 - .75	3/4"
.437 - 1.10	1"
.750 - 1.375	1 1/4"
.890 - 1.650	1 1/2"
1.125 - 2.438	2"
1.750 - 2.565	2 1/2"

NPT sizes are determined by the cable diameter and third party cord grip.

## Junction Boxes

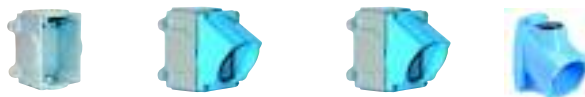

NPT	Metal Box	Metal Box with Nylon Angle	Metal Box with Metal Angle	Poly* Conduit Entry
1/2"	-	-	-	MC612
3/4"	-	-	-	MC634
1"	MB61	31-6A053-080-1	39-6A053-080-1	MC61
1 1/4"	MB6114	31-6A053-080-114	39-6A053-080-114	MC6114
1 1/2"	MB6112	31-6A053-080-112	39-6A053-080-112	-
2"	MB62	31-6A053-080-2	39-6A053-080-2	-

\* For poly devices only

## Miscellaneous Accessories



\* Set of Two (2) For Male Devices Only For Male Devices Only

Finger Drawplates	Protective Cap	Padlockable Cap Aluminum	Inlet Spring-Loaded cap
FDP6	31-6A126	DS6MC	31-6A226

\* Recommended for cord to cord assembly applications, for easier connector closure

## Order Example

A typical order should include an inlet part number, a receptacle part number **AND** the matching handles, angles or other required accessories.



Male Inlet with Handle (Plug)  
33-38540 + FH611



Female Receptacle with Angle Adapter  
33-34540 + MP6





## DR7 Multipin – 50A Plugs & Receptacles

### Ratings

- Voltage**  
50 VAC or 600 VAC Max
- Amperage Rating**  
50A Non-Current Interrupting
- Environmental Ratings**  
IP54/55
- Temperature Range**  
Min -40°F/Max 140°F  
See pg 194 for temps below -15°F.
- Wiring Capacity**  
Min 14 AWG Max 8 AWG
- Listings**  
Contact Customer Service

For DR7 dimensions, see pgs 143-144

### Receptacle (female)



### Inlet (male)



Voltage	Polarity	Part #	
		Poly	Metal
50V	4P	31-34940	39-34940
50V	5P	31-34950	39-34950
50V	6P	31-34960	39-34960
50V	7P	31-34970	39-34970
600V	3P+E	31-34931	39-34931
600V	4P+E	31-34941	39-34941
600V	5P+E	31-34951	39-34951
600V	6P+E	31-34961	39-34961

Voltage	Polarity	Part #	
		Poly	Metal
50V	4P	31-38940	39-38940
50V	5P	31-38950	39-38950
50V	6P	31-38960	39-38960
50V	7P	31-38970	39-38970
600V	3P+E	31-38931	39-38931
600V	4P+E	31-38941	39-38941
600V	5P+E	31-38951	39-38951
600V	6P+E	31-38961	39-38961

### Main Options



**Padlock Pawl**



**Emergency Stop Pawl**



**Self-Ejecting Devices**

*\* Requires straight insertion receptacle or inlet and self-ejecting plug or connector*

### Receptacle Options

### Part #

With 2 Auxiliary/Pilot contacts	Recept # - 172
With 3 Auxiliary/Pilot contacts	Recept # - 173
LP Watertightness (low pressure)	Recept # - LP
HP Watertightness (high pressure)	Recept # - HP
Straight Insertion	Recept # - A188
Self-Ejecting Connector Release	Recept # - 348-A188
Emergency Stop Pawl	Recept # - 375
Locking Mushroom Pawl	Recept # - 845
Padlock Pawl	Recept # - 843
Metal Pawl (on poly receptacle)	Recept # - 824
180° Opening Lid	Recept # - 180
Closed Lid Configuration	Recept # - NC
Recess Plate	Recept # - 142

### Inlet Options

### Part #

With 2 Auxiliary/Pilot contacts	Inlet # - 172
With 3 Auxiliary/Pilot contacts	Inlet # - 173
LP Watertightness (low pressure)	Inlet # - LP
HP Watertightness (high pressure)	Inlet # - HP
Self-Ejecting Plug Release	Inlet # - 338-A188
Straight Insertion	Inlet # - A188
With No Lockout Hole	Inlet # - A155

See pgs 171-180 for detailed information on these options

#### DR7 Order Example:

To order a device with an Emergency Stop Pawl add **-375** to the receptacle part number  
DR7 4P = 31-34940-375

# Installation Accessories

Unless indicated otherwise, accessories can be used with either poly or metal plugs and receptacles

## Handles



NPT	Poly Handle	Metal* Handle	Cable Range	Poly Handle w/Clamp & Bushing	Nylon Handle	Neoprene Handle	Poly Handle w/built in Draw Grips
1/2"	6PH12	6H12	.50 - 1.25	-	-	31-611	-
3/4"	6PH34	6H34	.51 - 1.38	-	FH611	-	FH611-473
1"	6PH1	6H1	1.250 - 1.375	6PM622	-	-	-
1 1/4"	6PH114	6H114	1.438 - 1.562	6PM625	-	-	-
1 1/2"	6PH112	6H112	1.562 - 1.688	6PM627	-	-	-
			1.688 - 1.812	6PM629	-	-	-

- Notes:**
- Finger draw plates are recommended for easier connector closure on cord to cord assemblies.
  - For available cord grips, see pgs 167-168.
  - \* For metal devices only

## Angles



Nylon 30° Angle	Metal 30° Angle	Metal 70° Angle	Metal Angle Oversized 30°	Metal Straight Adapter	Metal Lateral Angle 30°
MP6	MA6	89-6A027	MA660	MS6	MAB6

## NPT Guidelines

Cable Range	NPT
.062 - .5	1/2"
.187 - .75	3/4"
.437 - 1.10	1"
.750 - 1.375	1 1/4"
.890 - 1.650	1 1/2"
1.125 - 2.438	2"
1.750 - 2.565	2 1/2"

NPT sizes are determined by the cable diameter and third party cord grip.

## Junction Boxes

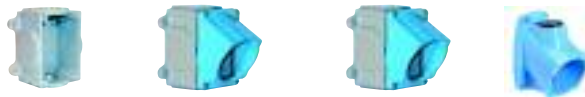

NPT	Metal Box	Metal Box with Nylon Angle	Metal Box with Metal Angle	Poly* Conduit Entry
1/2"	-	-	-	MC612
3/4"	-	-	-	MC634
1"	MB61	31-6A053-080-1	39-6A053-080-1	MC61
1 1/4"	MB6114	31-6A053-080-114	39-6A053-080-114	MC6114
1 1/2"	MB6112	31-6A053-080-112	39-6A053-080-112	-
2"	MB62	31-6A053-080-2	39-6A053-080-2	-

\* For poly devices only

## Miscellaneous Accessories



\* Set of Two (2) For Male Devices Only For Male Devices Only

Finger Drawplates	Protective Cap	Padlockable Cap Aluminum	Inlet Spring-Loaded cap
FDP6	31-6A126	DS6MC	31-6A226

\* Recommended for cord to cord assembly applications, for easier connector closure

## Order Example

A typical order should include an inlet part number, a receptacle part number **AND** the matching handles, angles or other required accessories.



Male Inlet with Handle (Plug)  
31-38940 + FH611



Female Receptacle with Angle Adapter  
31-34940 + MP6



# Spare Parts Male Configuration

PN pictured

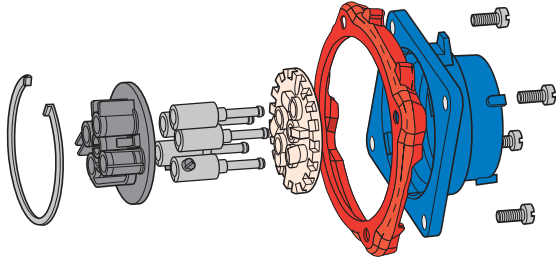

DN pictured

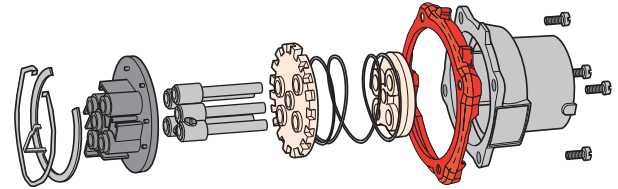

PN7	POLY	METAL
Plug Interior, Ground Contact & Connection	09-PA910	09-PA910
Plug Contact	09-PA911	09-PA911
Device Gasket	61-1AM26	61-1AM26
Plug Casing	01-NA014	09-NA014
Ground Contact	09-PA919	09-PA919

PN12	POLY	METAL
Plug Interior, Ground Contact & Connection	09-MA910	09-MA910
Plug Contact	01-MA911	01-MA911
Device Gasket	61-1AM26	61-1AM26
Plug Casing	01-NA014	09-NA014
Ground Contact	09-MA919	09-MA919

DSN24/37	24 POLY	37 POLY
Plug Interior	31-1A910	31-3A910
Plug Contact	31-1A911	31-1A911
Plug Casing	61-3A014	61-6A014
Device Gasket	61-3AM26	31-3AM26

DN9/20	9 METAL	20 METAL
Plug Interior	19-1A910	19-6A910
Plug Contact (Short/Outside)	19-1A911	19-6A911
Plug Contact (Long/Inside)	19-1A711	19-6A711
Plug Casing	19-1A014	19-6A014
Device Gasket	31-3A026	31-9A026

DS7/DR7	POLY	METAL
Plug Casing	31-6A014	39-6A014
Plug Phase Contact	31-3A911	31-3A911
Plug Pilot Contact	31-3A911-172	31-3A911-172
Plug Interior	31-3A910-263	31-3A910-263
Device Gasket	31-6AM26	31-6AM26
Ground Contact	31-3A919	31-3A919

DN7	50 METAL	90 METAL	150 METAL
Plug Casing	19-3A014	19-6A014	39-2A014
Plug Phase Contact	19-3A011-777	19-6A011-777	19-9A011-777
Plug Ground Contact	19-3A019-777	19-6A019-777	19-9A019-777
Plug Interior	19-3A010-777	19-6A010-777	19-9A010-777
Device Gasket	31-6A026	31-9A026	39-2A026

# Spare Parts Female Configuration

PN pictured

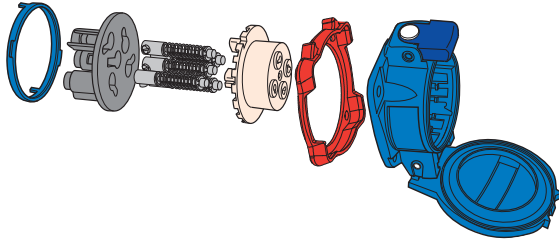

DN pictured

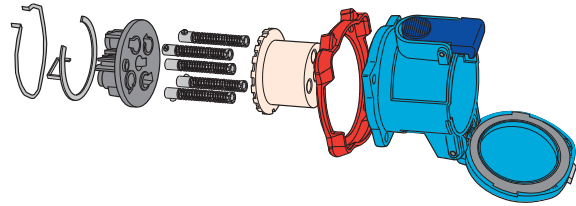

PN7	POLY	METAL
Receptacle Interior, Ground Contact & Connection	09-PA920	09-PA920
Receptacle Contact	09-PA921	09-PA921
Device Gasket	61-1AM26	61-1AM26
Receptacle Casing	01-NA024	09-NA024
Ground Contact	09-PA929	09-PA929

PN12	POLY	METAL
Receptacle Interior, Ground Contact & Connection	09-MA920	09-MA920
Receptacle Contact	01-MA921	01-MA921
Device Gasket	61-1AM26	61-1AM26
Receptacle Casing	01-NA024	09-NA024
Ground Contact	09-MA929	09-MA929

DSN24/37	24 POLY	37 POLY
Receptacle Interior	31-1A920	31-3A920
Receptacle Contact	31-1A921	31-1A921
Receptacle Casing	61-3A024	61-6A024
Device Gasket	61-3AM26	31-3AM26

DN9/20	9 METAL	20 METAL
Receptacle Interior	19-1A920	19-6A920
Receptacle Contact (Short/Outside)	19-1A921	19-6A921
Receptacle Contact (Long/Inside)	19-1A721	19-6A721
Receptacle Casing	19-1A024	19-6A024
Lid, Gasket, Roll Pin & Spring	19-1A925	19-6A925
Device Gasket	31-3A026	31-9A026

DS7/DR7	POLY	METAL
Receptacle Casing	31-6A024	39-6A024
Receptacle Phase Contact	31-3A921	31-3A921
Receptacle Pilot Contact	31-3A921-172	31-3A921-172
Receptacle Interior	31-3A920-263	31-3A920-263
Device Gasket	31-6AM26	31-6AM26
Ground Contact	31-3A929	31-3A929

DN7	50 METAL	90 METAL	150 METAL
Receptacle Casing	19-3A024	19-6A024	39-2A024-777
Receptacle Phase Contact	19-3A021-777	19-6A021-777	19-9A021-777
Receptacle Ground Contact	19-3A029-777	19-6A029-777	19-9A029-777
Receptacle Interior	19-3A020-777	19-6A020-777	19-9A020-777
Device Gasket	31-6A026	31-9A026	39-2A026

For replacement parts contact customer service at 800.433.7642



# Dimensions

## Inlet – Provided in inches and millimeters

Dimensions are for reference only

### Plug

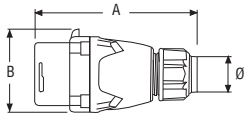

PRODUCT	A	B	Ø
	10.24	5.55	1.50-2.25
DN7(150A)	260	141	40-58
DN9	5.79	3.39	.32-1.25
	147	86	8-32
DN7(50A)	7.68	3.98	.55-1.53
	195	101	14-39
DN7(90A)/DN20	8.46	4.76	1.00-1.75
	215	121	25-45

### Inlet with connector on/off

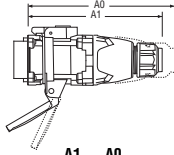

PRODUCT	A1	A0
	12.20	13.43
DN7(150A)	310	341
DN9	6.85	7.60
	174	193
DN7(50A)	8.35	9.53
	212	242
DN7(90A)/DN20	10.67	9.41
	271	239

### Inlet

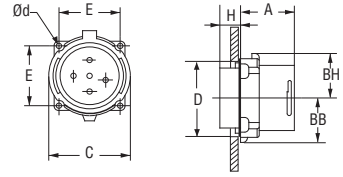

PRODUCT	A	BB	BH	C	D	E	H	Ød
	3.11	2.87	2.68	5.12	4.65	3.86	1.57	0.26
DN7(150A)	79	73	68	130	118	98	40	6.5
DN9	2.01	1.77	1.61	3.03	2.76	2.17	0.59	0.20
	51	45	41	77	70	55.1	15	5
DN7(50A)	3.03	2.09	1.89	3.58	3.15	2.59	0.87	0.23
	77	53	48	91	80	65.8	22	5.8
DN7(90A)/DN20	3.50	2.52	2.22	4.33	3.94	3.20	0.98	0.23
	89	64	56.5	110	100	81.3	25	5.8

### 30° inclined inlet/angle with connector on/off

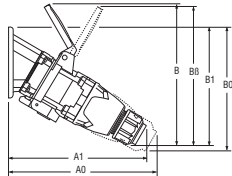

PRODUCT	A1	A0	B	B1	B0
	11.50	12.13	16.81	13.66	14.72
DN7(150A) 60°	292	308	427	347	374
DN9	8.03	8.66	8.23	7.01	7.36
	204	220	209	178	187
DN7(50A)	9.53	10.51	9.21	8.66	9.25
	242	267	234	220	235
DN7(90A)/DN20	12.72	11.65	11.22	10.04	9.41
	323	296	285	255	239

### 30° inlet/angle

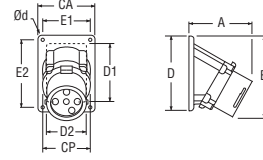

PRODUCT	A	B	CA	CP	D	D1	E1	E2	Ød
	6.93	8.90	7.20	5.12	7.20	5.91	5.91	6.50	0.28
DN7(150A) 60°	176	226	183	130	183	150	150	165	7
DN9	3.86	4.65	2.99	3.03	4.21	2.56	3.74	2.48	0.22
	98	118	76	77	107	65	95	63	5.5
DN7(50A)	5.00	6.14	4.02	3.58	5.35	4.37	3.54	3.44	0.26
	127	156	102	91	136	111	90	87.3	6.5
DN7(90A)/DN20	6.57	6.54	5.51	4.33	5.59	4.33	3.94	4.87	0.28
	167	166	140	110	142	110	100	123.8	7

### 30° inclined inlet/angle/junction box with connector on/off

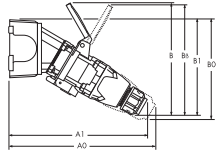

PRODUCT	A1	A0	B	B1	B0
	15.67	16.30	16.81	13.66	14.72
DN7(150A) 60°	398	414	427	347	374
DN9	10.51	11.14	8.23	7.13	7.48
	267	283	209	181	190
DN7(50A)	12.60	13.58	9.21	8.86	9.45
	320	345	234	225	240
DN7(90A)/DN20	16.34	15.28	11.22	10.04	9.41
	415	388	285	255	239

### inlet/angle/metal junction box

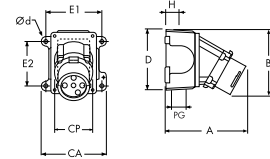

PRODUCT	A	B	CA	CP	D	E1	E2	H	PG	Ød
	11.10	8.90	8.94	5.12	7.32	8.25	6.38	2.05	2.50	0.33
DN7(150A) 60°	282	226	227	130	186	209.6	162	52		8.4
DN9	6.34	4.40	4.25	3.03	4.57	3.75	2.78	1.18	1.00	0.25
	161	111.8	108	77	116	95.3	70.6	30		6.4
DN7(50A)	8.07	5.75	5.59	3.58	5.81	5.00	3.82	1.57	1.50	0.30
	205	146	142	91	147.5	127	97	40		7.5
DN7(90A)/DN20	10.20	7.54	7.44	4.33	5.65	6.62	4.24	1.93	2.00	0.31
	259	191.5	189	110	143.5	168.1	107.7	49		7.8

# Dimensions

## Receptacle – Provided in inches and millimeters

DN

Dimensions are for reference only

### connector

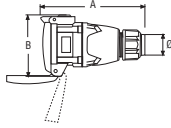

PRODUCT	A	B	Ø
	11.46	6.57	1.50-2.25
DN7(150A)	291	167	40-58
	6.65	3.86	.32-1.25
DN9	169	98	8-32
	7.87	4.53	.55-1.53
DN7(50A)	200	115	14-39
	8.82	5.20	1.00-1.75
DN7(90A)/DN20	224	132	25-45

### receptacle with plug on/off

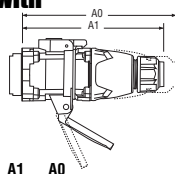

PRODUCT	A1	A0
	12.20	13.43
DN7(150A)	310	341
	6.85	7.60
DN9	174	193
	8.35	9.53
DN7(50A)	212	242
	10.67	9.41
DN7(90A)/DN20	271	239

### receptacle

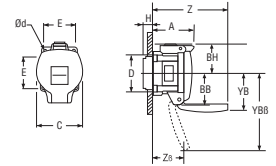

PRODUCT	A	BB	BH	C	D	E	H	YB	Z	Ød
	4.31	2.95	3.62	5.16	4.65	3.86	1.50	4.53	8.38	0.26
DN7(150A)	109.5	75	92	131	118	98	38	115	212.9	6.5
	2.88	1.93	1.93	2.91	2.76	2.17	0.59	3.39	4.93	0.20
DN9	73.1	49	49	74	70	55.1	15	86	125.3	5
	3.82	2.28	2.24	3.50	3.15	2.59	0.87	3.74	5.69	0.23
DN7(50A)	97	58	57	89	80	65.8	22	95	144.6	5.8
	4.34	2.64	2.56	4.41	3.94	3.20	0.94	4.25	7.68	0.23
DN7(90A)/DN20	110.3	67	65	112	100	81.3	24	108	195.1	5.8

### 30° inclined receptacle/angle with plug on/off

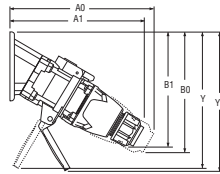

PRODUCT	A1	A0	B1	B0	Y
	11.50	12.13	13.66	14.72	11.54
DN7(150A) 60°	292	308	347	374	293
	4.09	8.66	7.01	7.36	8.03
DN9	104	220	178	187	204
	9.53	10.51	8.66	9.25	9.49
DN7(50A)	242	267	220	235	241
	12.72	11.65	10.04	9.41	10.75
DN7(90A)/DN20	323	296	255	239	273

### 30° receptacle/angle

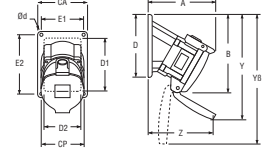

PRODUCT	A	B	CA	CP	D	D1	D2	E1	E2	Y	Z	Ød
	8.78	9.80	7.20	5.16	7.20	5.91	5.91	6.50	6.50	14.96	3.78	0.28
DN7(150A) 60°	223	249	183	131	183	150	150	165	165	380	96	7
	5.00	6.77	2.99	2.91	4.21	2.56	3.74	2.48	3.74	8.03	4.13	0.22
DN9	127	172	76	74	107	65	95	63	95	204	105	5.5
	6.06	8.23	4.02	3.50	5.35	4.37	3.54	3.44	4.80	9.49	4.72	0.26
DN7(50A)	154	209	102	89	136	111	90	87.3	122	241	120	6.5
	7.68	9.33	5.51	4.41	5.59	4.33	3.94	4.87	4.87	10.75	7.17	0.28
DN7(90A)/DN20	195	237	140	112	142	110	100	123.8	123.8	273	182	7

### 30° inclined receptacle/angle/ junction box with plug on/off

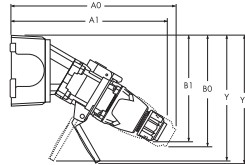

PRODUCT	A1	A0	B1	B0	Y
	15.67	16.30	13.66	14.72	11.54
DN7(150A) 60°	398	414	347	374	293
	6.57	11.14	7.13	7.48	8.15
DN9	167	283	181	190	207
	12.60	13.58	8.86	9.45	9.69
DN7(50A)	320	345	225	240	246
	16.34	15.28	10.04	9.41	10.75
DN7(90A)/DN20	415	388	255	239	273

### receptacle/angle/ metal junction box

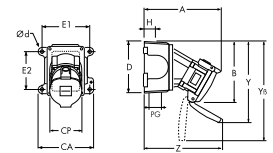

PRODUCT	A	B	CA	CP	D	E1	E2	H	PG	Y	Z	Ød
	12.95	9.80	8.94	5.16	7.32	8.25	6.38	2.05	2.50	14.96	11.89	0.33
DN7(150A) 60°	329	249	227	131	186	209.6	162	52		380	302	8.4
	7.48	6.89	4.40	2.91	4.57	3.75	2.78	1.18	1.00	8.15	6.61	0.25
DN9	190	175	111.8	74	116	95.3	70.6	30		207	168	6.4
	9.13	8.43	5.75	3.50	5.81	5.00	3.82	1.57	1.50	9.69	7.80	0.30
DN7(50A)	232	214	146	89	147.5	127	97	40		246	198	7.5
	11.31	9.33	7.54	4.41	5.65	6.62	4.24	1.93	2.00	10.75	10.79	0.31
DN7(90A)/DN20	287	237	191.5	112	143.5	168.1	107.7	49		273	274	7.8

# PF / PFQ



Features and Ratings	p. 120
PF/PFQ 300-600A	p. 121
Spare parts	p. 123
Dimensions	p. 124



## High amperage plugs & receptacles

PF and PFQ Series plugs and receptacles are engineered for use in high amperage applications where routine plug insertion and high reliability are required. They are ideal for power supply applications in mining, petroleum platform, ship to shore, power generation system, shipyard and other similar harsh environments.

### Main Advantages

- ▼ Durable in harsh environments
- ▼ Safety features provide maximum protection
- ▼ Easy plug insertion and removal



*PFQ300 devices are differentiated from similarly rated PF300 devices in their smaller size, lighter weight and different pilot contacts.*

# Product Features

## Auxiliary Pilot Contacts

Provided for use with control circuits. They close after and open before the phase contacts.

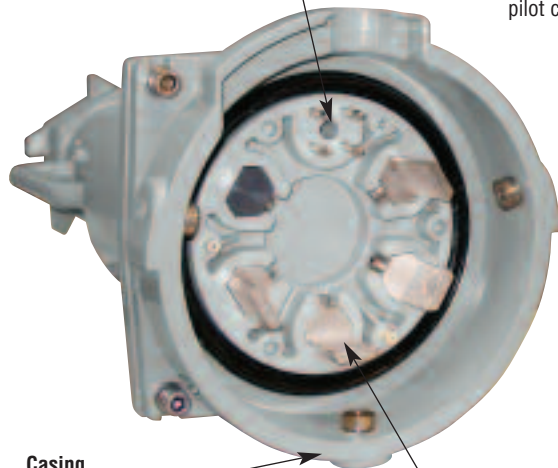

## Mechanical Locking System

Ensures safety and watertightness. Mechanical lock secures the inlet to the receptacle and engages the pilot contacts.



## Casing

Epoxy coated aluminum material offers great resistance to harsh environments.

## Silver Pressure Contacts

Silver material and self-cleaning action provides maximum conductivity and performance in dirty and corrosive conditions.

## Safety Shutter

Protects recessed female contacts and inhibits user access to live parts.

## Operating Instructions



PF devices are preferred for the ease of operation relative to pin and sleeve devices.



Insert the plug into the receptacle – this is done with little resistance relative to competitive devices.



Twist plug approximately 30° clockwise to engage the phase contacts and make unit watertight.

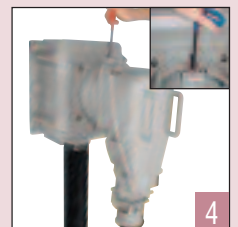

Turning the mechanical lock secures the inlet to the receptacle and engages the pilot contacts which energize the circuit.

5 To disconnect, turn mechanical lock to disengage pilot contacts and de-energize the circuit. Twist plug 30° counter-clockwise to disengage the phase contacts, withdraw plug.

## General Ratings

Amperage	300 to 600A
Voltage <sup>+</sup>	1000 VAC*, 1000 VDC Max
Frequency	50-400 Hz
Environmental	IP66 + 67
Temperature	min -40°F/max 140°F

\* 600 VAC max for PFQ devices

+ UL listings do not apply above 600VAC and 250VDC

## Listings

Category	UL	CSA
Plugs and Receptacles	UL 1682*	C22.2 No. 182.1*

\* Listings only apply to 300A and 400A devices at 600V or less



PFQ3 devices are differentiated from similarly rated PF3 devices in their smaller size, lighter weight and different pilot contacts.

## Highlighted Feature Pilot Contacts

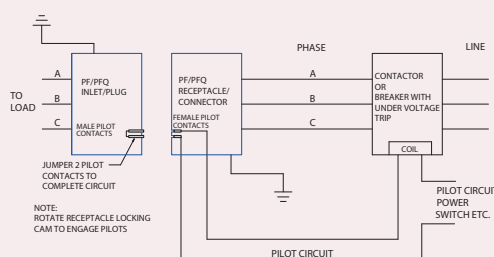

Line diagram of typical PF pilot control circuit

Category	PF	PFQ
# Contacts	4	8
Pilot Amperage	10A standard duty	2A pilot duty
Interlocking Type	Mechanical	Mechanical
Terminal Type	Screw	Solder/crimp

Notes: • The mechanical locking of the plug to the receptacle, via the rotation of a cam, closes the pilot contacts.  
• Failure to use a pilot/relay system can create an electrical shock hazard.





# PF/PFQ – 300A - 600A High Ampacity Plugs & Receptacles

### Ratings

- Voltage**  
PF = 1000 VAC<sup>1</sup>, 250 VDC  
PFQ = 600 VAC, 250 VDC  
<sup>1</sup> Listings apply only to 300A & 400A devices at 600V or less
- Current Interruption Capability**  
Not for current interrupting
- Environmental Ratings**  
IP66 + 67
- Temperature Range**  
Min -40°F/Max 140°F  
See pg 194 for temps below -15°F.
- Wiring Capacity**  
PFQ = 4/0 AWG to 350 MCM  
PF = 250 MCM to 600 MCM
- Pilot Contacts**  
PFQ = 8  
PF = 4
- Listings**  
UL, CSA

*PFQ300 devices are differentiated from similarly rated PF300 devices in their smaller size, lighter weight and different pilot contacts.*

### Receptacle / Cap (female) 300A



*Don't forget to add installation accessories to your order*

Voltage	Polarity	Part #	
		PFQ300	PF300
277V	1P+N+E	47-34045	49-34045
347V	1P+N+E	47-34145	49-34145
480V	2P+E	47-34042	49-34042
480V	2P+N+E	47-34046	49-34046
480V	3P+E	47-34043	49-34043
480V	3P+N+E	47-34047	49-34047
600V	2P+E	47-34142	49-34142
600V	2P+N+E	47-34146	49-34146
600V	3P+E	47-34143	49-34143
600V	3P+N+E	47-34147	49-34147



### Inlet / Cap (male) 300A



Voltage	Polarity	Part #	
		PFQ300	PF300
277V	1P+N+E	47-38045	49-38045
347V	1P+N+E	47-38145	49-38145
480V	2P+E	47-38042	49-38042
480V	2P+N+E	47-38046	49-38046
480V	3P+E	47-38043	49-38043
480V	3P+N+E	47-38047	49-38047
600V	2P+E	47-38142	49-38142
600V	2P+N+E	47-38146	49-38146
600V	3P+E	47-38143	49-38143
600V	3P+N+E	47-38147	49-38147

*Other voltage configurations are available – contact customer service at 800.433.7642.*

### Main Options

-  **Receptacle with no cap**  
With no cap Recept # - 48
-  **Inlet with no cap**  
With no cap Inlet # - 48

**Notes:** • Metal caps are provided as standard with male and female devices.

*PF/PFQ devices are not intended for connection or disconnection under load. To prevent live making or breaking electrical interlocking is required.*

### Receptacle / Cap (female) 400A / 600A



Voltage	Polarity	Part #	
		PF400	PF600
277V	1P+N+E	49-44045	49-64045
347V	1P+N+E	49-44145	49-64145
480V	2P+E	49-44042	49-64042
480V	2P+N+E	49-44046	49-64046
480V	3P+E	49-44043	49-64043
480V	3P+N+E	49-44047	49-64047
600V	2P+E	49-44142	49-64142
600V	2P+N+E	49-44146	49-64146
600V	3P+E	49-44143	49-64143
600V	3P+N+E	49-44147	49-64147

### Inlet / Cap (male) 400A / 600A

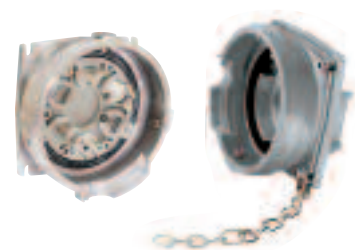

Voltage	Polarity	Part #	
		PF400	PF600
277V	1P+N+E	49-48045	49-68045
347V	1P+N+E	49-48145	49-68145
480V	2P+E	49-48042	49-68042
480V	2P+N+E	49-48046	49-68046
480V	3P+E	49-48043	49-68043
480V	3P+N+E	49-48047	49-68047
600V	2P+E	49-48142	49-68142
600V	2P+N+E	49-48146	49-68146
600V	3P+E	49-48143	49-68143
600V	3P+N+E	49-48147	49-68147

# Installation Accessories

## Handles

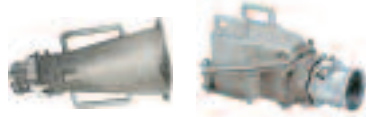

Inlet/Receptacle Size	Cable Range	Metal Straight Handle	Metal 90° Angled Handle
PFQ3	See table	47-3A013-XXX	47-3A913-XXX
PF3	See table	49-3A013-XXX	49-3A913-XXX
PF4	See table	49-4A013-XXX	49-4A913-XXX
PF6	See table	49-6A013-XXX	49-6A913-XXX

## Cable Ranges

XXX (Suffix #)	Cable Range	XXX (Suffix #)	Cable Range
-200	2.000 - 2.125	-300	2.750 - 3.000
-225	2.125 - 2.250	-312	3.000 - 3.125
-237	2.250 - 2.375	-335	3.125 - 3.350
-250	2.375 - 2.500	-350	3.350 - 3.500
-275	2.500 - 2.750	-	-

## Junction Boxes

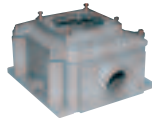

Inlet/Receptacle Size	Hub Sizes	Metal Junction Box
PFQ3	See table	MB40PFQ-XX
PF3	See table	MB40-XX
PF4	See table	MB40-XX
PF6	See table	MB40-XX

## Hub Sizes

XX (Suffix #)	Fitting Size
-20	2" NPT
-25	2.5" NPT
-30	3" NPT
-35	3.5" NPT
-40	4" NPT

## Highlighted Feature

### Bolt-on Lug

#### Angled Lug

#### Straight Lug



The PF and PFQ contacts utilize bolt-on lug type wire terminals, which require a compression lug with a 9/16" or 5/8" hole. The angled handle requires straight lugs; the straight handle requires 90° lugs. Lugs are not included.

## Miscellaneous Accessories

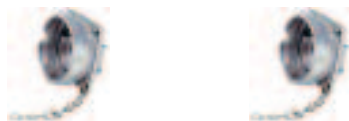

Inlet/Receptacle Size	Inlet Replacement Metal Cap	Receptacle Replacement Metal Cap
PFQ3	47-3A126	47-3A925
PF3	49-3A126	49-3A925
PF4	49-4A126	49-4A925
PF6	49-6A126	49-6A925

## Weights

Part	PF	PFQ3
Inlet	15 lbs	9 lbs
Receptacle	25 lbs	12 lbs
Angled Handle	15 lbs	12 lbs
Straight Handle	10 lbs	10 lbs
Junction Box	45 lbs	45 lbs
Cap	3 lbs	3 lbs

## Order Example

A typical order should include an inlet part number, a receptacle part number **AND** the matching handles, angles or other required accessories.



**Male Inlet with Handle (Plug)**  
47-38047 + 47-3A913-200



**Female Receptacle with Junction Box**  
47-34047 + MB40-20



# Spare Parts

## Male Configuration

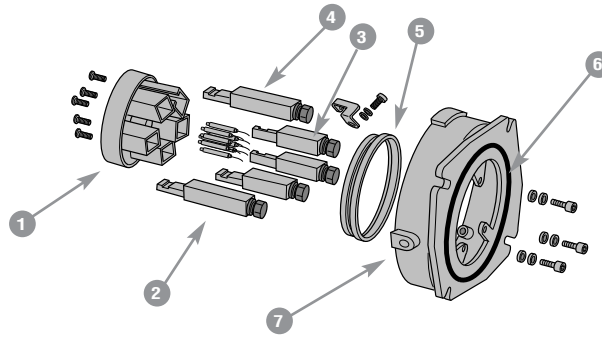

	PFQ300A METAL	PF300A METAL	PF400A METAL	PF600A METAL
① = Plug Interior*	47-3A010	49-3A010	49-4A010	49-6A010
② = Phase Contact	47-3A011	49-3A011	49-4A011	49-6A011
③ = Neutral Contact	47-3A011N	49-4A011N	49-4A011N	49-6A011N
④ = Ground Contact	47-3A019	49-4A019	49-4A019	49-6A019
⑤ = Inside Gasket	CPF403PFQ	CPF403	CPF403	CPF403
⑥ = Outside Gasket	CPF405PFQ	CPF405	CPF405	CPF405
⑦ = Plug Metal Casing*	47-3A014	49-3A014	49-4A014	49-6A014

## Female Configuration

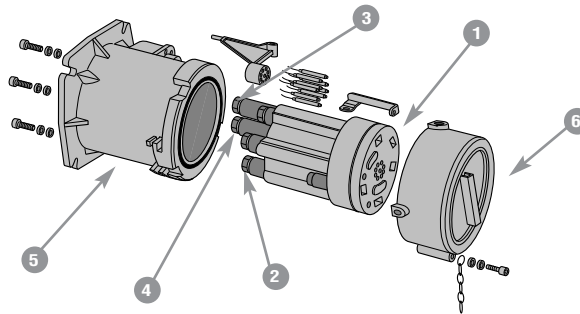

	PFQ300A METAL	PF300A METAL	PF400A METAL	PF600A METAL
① = Receptacle Interior*	47-3A020	49-3A020	49-4A020	49-6A020
② = Phase Contact	47-3A021	49-3A021	49-4A021	49-6A021
③ = Neutral Contact	47-3A021N	49-3A021N	49-4A021N	49-6A021N
④ = Ground Contact	47-3A029	49-3A029	49-4A029	49-6A029
⑤ = Receptacle Metal Casing*	47-3A024	49-3A024	49-4A024	49-6A024
⑥ = Cap (Receptacle)	47-3A925	49-3A925	49-3A925	49-3A925
Inside Gasket (Not Shown)	CPF403PFQ	CPF403	CPF403	CPF403
Outside Gasket (Not Shown)	CPF405PFQ	CPF405	CPF405	CPF405

\* Voltage and phasing positions must be specified (5th, 6th and 7th digit of part #)

# Dimensions

## Inlet – Provided in inches and millimeters

Dimensions are for reference only

### straight plug

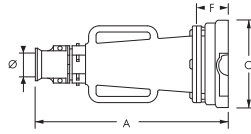

PRODUCT	A	C	F	Ø
	23.03	7.72	2.95	2.0-3.5
PFQ	585	196	75	50-90
	26.57	9.06	3.74	2.0-3.5
PF	675	230	95	50-90

### angled plug

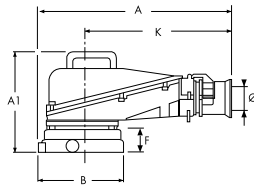

PRODUCT	A	A1	B	F	K	Ø
	18.50	11.50	9.45	2.95	13.86	2.0-3.5
PFQ	470	292	240	75	352	50-90
	23.43	12.60	10.47	3.74	17.99	2.0-3.5
PF	595	320	266	95	457	50-90

### straight connector

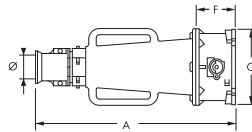

PRODUCT	A	C	F	Ø
	24.72	7.72	4.65	2.0-3.5
PFQ	628	196	118	50-90
	27.56	9.06	4.72	2.0-3.5
PF	700	230	120	50-90

### angled connector

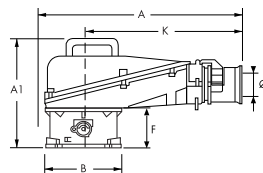

PRODUCT	A	A1	B	F	K	Ø
	18.50	13.15	9.45	4.65	14.65	2.0-3.5
PFQ	470	334	240	118	372	50-90
	23.43	13.39	9.84	4.72	17.99	2.0-3.5
PF	595	340	250	120	457	50-90

### inlet

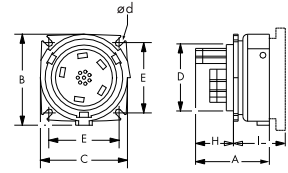

PRODUCT	A	B	C	D	E	H	I	Ød
	6.10	9.45	7.72	5.31	5.75	3.15	6.89	0.43
PFQ	155	240	196	135	146	80	175	11
	7.68	10.47	9.06	6.89	7.48	3.94	8.27	0.43
PF	195	266	230	175	190	100	210	11

### inlet on surface box

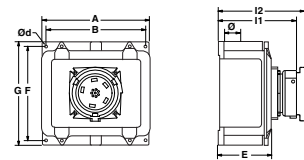

PRODUCT	A	B	E	F	G	I1	I2	Ø	Ød
	15.70	14.63	13.75	15.15				2.0-4.0	0.41
PFQ/PF	398.8	371.6	349.3	384.8					10.4
	15.70	14.63	8.62	13.75	15.15	11.62	16.87	2.0-4.0	0.41
PFQ	398.8	371.6	218.9	349.3	384.8	295.1	428.5		10.4
	15.70	14.63	8.81	13.75	15.15	12.56	19.44	2.0-4.0	0.41
PF	398.8	371.6	223.8	349.3	384.8	319	493.8		10.4

### receptacle

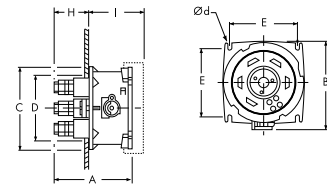

PRODUCT	A	B	C	D	E	H	I	Ød
	7.64	9.45	7.72	5.51	5.75	2.99	6.89	0.39
PFQ	194	240	196	140	146	76	175	10
	8.66	9.84	9.06	7.28	7.48	3.94	8.27	0.39
PF	220	250	230	185	190	100	210	10

### receptacle on surface box

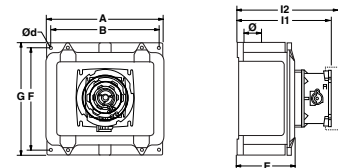

PRODUCT	A	B	E	F	G	I1	I2	Ø	Ød
	15.70	14.63	13.75	15.15				2.0-4.0	0.41
PFQ/PF	398.8	371.6	349.3	384.8					10.4
	15.70	14.63	8.62	13.75	15.15	13.24	15.74	2.0-4.0	0.41
PFQ	398.8	371.6	218.9	349.3	384.8	336.3	399.8		10.4
	15.70	14.63	8.81	13.75	15.15	13.68	19.68	2.0-4.0	0.41
PF	398.8	371.6	223.8	349.3	384.8	347.5	499.9		10.4



## Single Pole, High Amperage Plugs & Receptacles

SP devices are designed for safety, durability and ease of operation. SP receptacles are IP 2X rated to prevent accidental finger contact with live parts and are also equipped with pilot contacts for controlling the power circuit. The pilot contacts are interlocked with the latching mechanism to prevent connection or disconnection under load.

Five different mechanical keying positions for L1, L2, L3, N and E prevent accidental insertion of the wrong plug into a receptacle. Color coding simplifies identification of mating devices.

### Main Advantages

- ▼ Safety features provide maximum protection
- ▼ Silver-nickel, butt-style contact technology maximizes durability
- ▼ IP 66+67 environmental protection

# Product Features

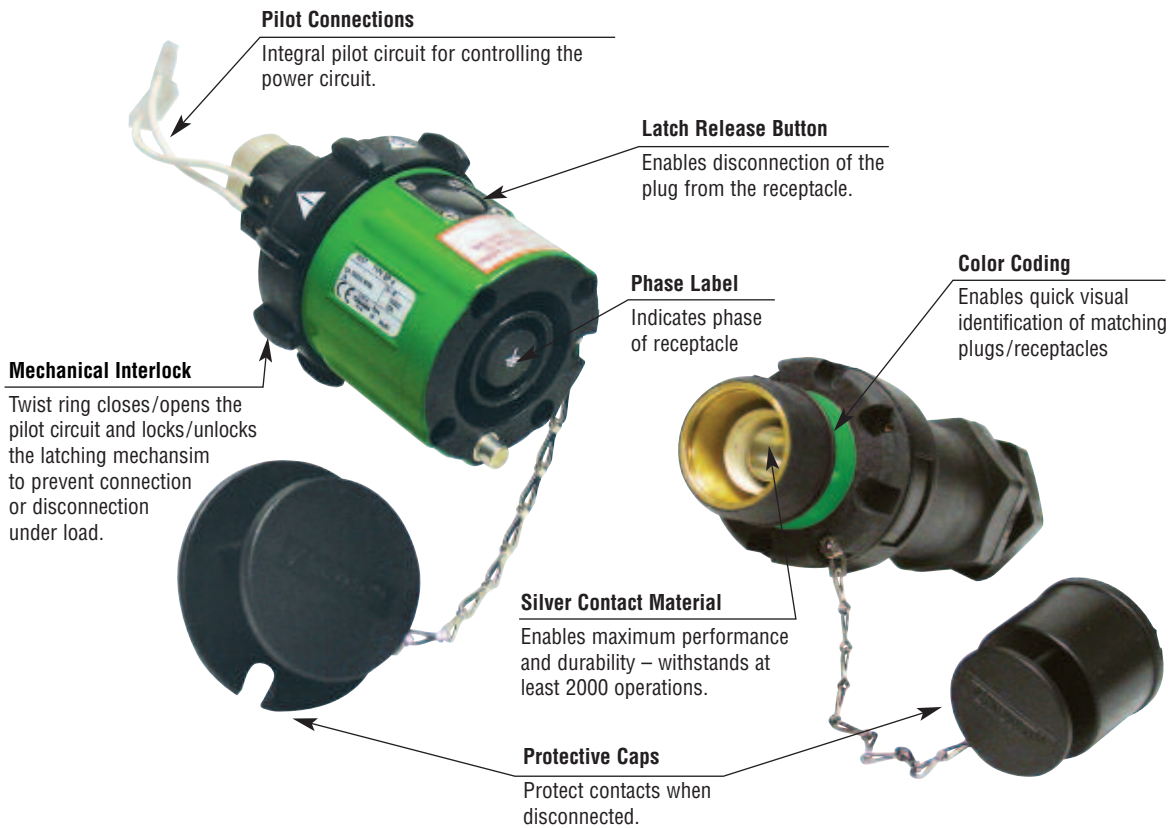

## Operating Instructions

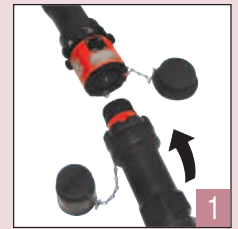

To connect, insert the plug into the receptacle until a click is heard. Rotation of the plug in either direction engages a locking finger on the receptacle, which prevents further rotation.



To close the pilot circuit and mechanically lock the plug into the receptacle, turn the ring on the receptacle until the "1" lines up with the arrow across from the release button. This turns the power on.



To disconnect, open the pilot circuit and unlock the plug by turning the ring until the "0" is aligned with the arrow. The power is now off.



Press firmly on the latch release button and simultaneously pull on the inlet. A slight rotation of the plug may also be required before it can be removed.

## General Ratings

Amperage	700A
Voltage	1000 VAC, 1500 VDC Max
Frequency	50-400 Hz
Environmental	IP66+67
Temperature	min -15°F/max 140°F

## Plug & Receptacle Listings

Category	IEC
Plugs and Receptacles	60309-1

*CE ratings available upon request*

## Highlighted Feature

### Pilot Circuit



SP plugs and connectors are designed with safety and durability in mind. Each device is mechanically interlocked with an integral pilot circuit switch for controlling the power circuit in order to prevent connection and disconnection under load.

### A typical pilot circuit wiring diagram

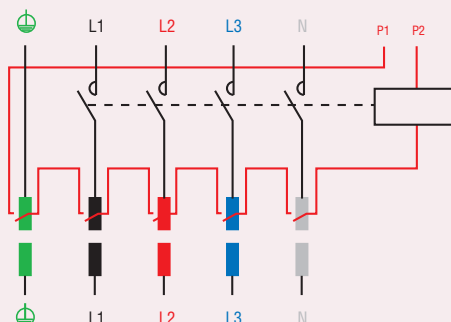



# SP – 700A Single Pole Plugs & Receptacles

### Main Features

- **Voltage**  
1000 VAC, 1500VDC
- **Current Interruption Capability**  
Non-Load break
- **Environmental Ratings**  
IP66+67
- **Temperature Range**  
Min -15°F/Max 140°F
- **Wiring Capacity**  
Min 2/0 Max 777 MCM  
Aux Contacts 12-14 AWG
- **Listings**  
IEC
- **Pilot Contact Amperage**  
10A

### Receptacle (female) without lug



Don't forget to add installation accessories to your order

### Inlet (male) without lug



Color Code	Polarity	Part # without lug
	L1	45-44001-P80
	L2	45-44002-P80
	L3	45-44003-P80
	NEUTRAL	45-4400N-P80
	EARTH	45-4400T-P80
	POSITIVE	45-4400P-P80
	NEGATIVE	45-4400M-P80

Color Code	Polarity	Part # without lug
	L1	45-48001-P80
	L2	45-48002-P80
	L3	45-48003-P80
	NEUTRAL	45-4800N-P80
	EARTH	45-4800T-P80
	POSITIVE	45-4800P-P80
	NEGATIVE	45-4800M-P80

### Crimping lug\*



### Crimping lug\*

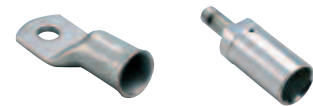

### Main Options

	<b>Handle</b>
<b>Wire Size</b> mm <sup>2</sup>	<b>Part #</b>
4/0 to 500 MCM	45-4A753
600 to 777 MCM	45-4A783
	<b>Inclined Metal</b> Angle 45°
<b>Angle</b>	<b>Part #</b>
Angle	45-4A027

Flexible MCM <sup>+</sup> Wire Size	Straight with Terminal	Straight Threaded**
4/0	45-4A95C	45-4A95D
250	45-4A12C	45-4A12D
300	45-4A15C	45-4A15D
350	45-4A18C	45-4A18D
500	45-4A24C	45-4A24D
600	45-4A30C	45-4A30D
777	45-4A40C	45-4A40D

Flexible MCM <sup>+</sup> Wire Size	Straight with Terminal	Straight Threaded**
4/0	45-4A95C	45-4A95D
250	45-4A12C	45-4A12D
300	45-4A15C	45-4A15D
350	45-4A18C	45-4A18D
500	45-4A24C	45-4A24D
600	45-4A30C	45-4A30D
777	45-4A40C	45-4A40D

\* Use the straight threaded lug when combining a handle with a receptacle

\*\* Straight threaded lug can be used for solder connection as well as crimp connection  
Lugs should be crimped per IEC 1238-1

+ Based on flexible type copper cables. See appropriate NEC tables for applicable ampacities

# Dimensions

## Inlet & Receptacle – Provided in inches and millimeters

Dimensions are for reference only

### inlet

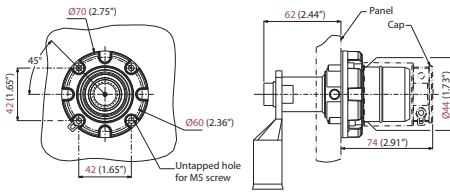

### receptacle

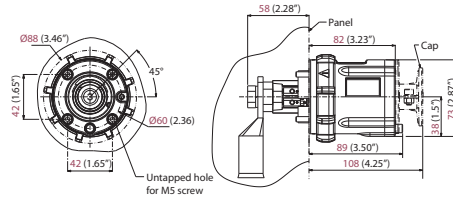

### plug

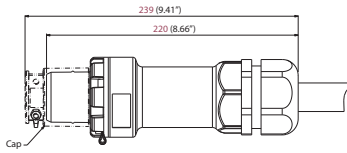

### plug / connector

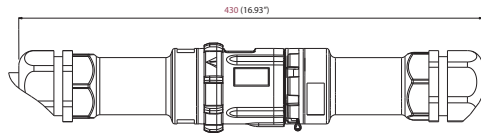

### connector

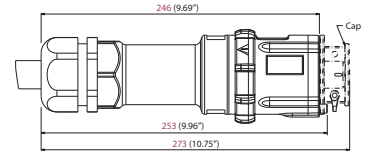

### plug with connector on / off

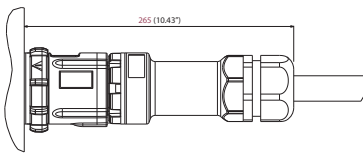

### connector with plug on / off

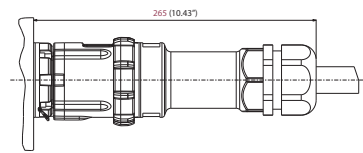

### 45° inclined receptacle / angle with plug

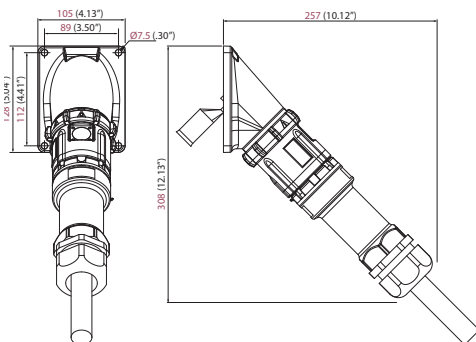

### 45° inclined inlet / angle with connector

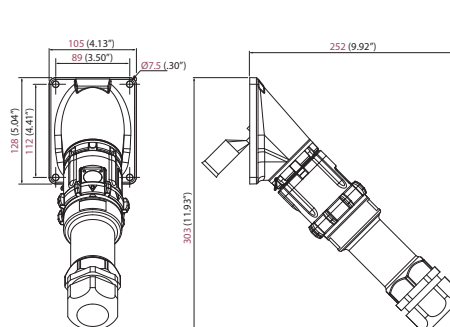



# DR



Features and Ratings	p. 130
DR30	p. 131
DR50	p. 133
DR100	p. 135
DR150	p. 137
DR 250	p. 139
Spare parts	p. 141
Dimensions	p. 143



## Robust construction and high amperage capabilities

DR series plugs and receptacles provide safe, economical and robust connections for applications up to 250A. Some DR models are non-current interrupting rated, while others are suitable for current interruption on resistive loads (see table on next page). The DR's spring-loaded, silver-nickel butt contacts and dead front construction provide more consistent and reliable connections and significant improvements in operator safety compared to competitive devices.

### Main Advantages

- ▼ High amperage capacity
- ▼ Up to 5 auxiliary contacts
- ▼ Robust Metal or Poly construction

# Product Features

DSN pictured

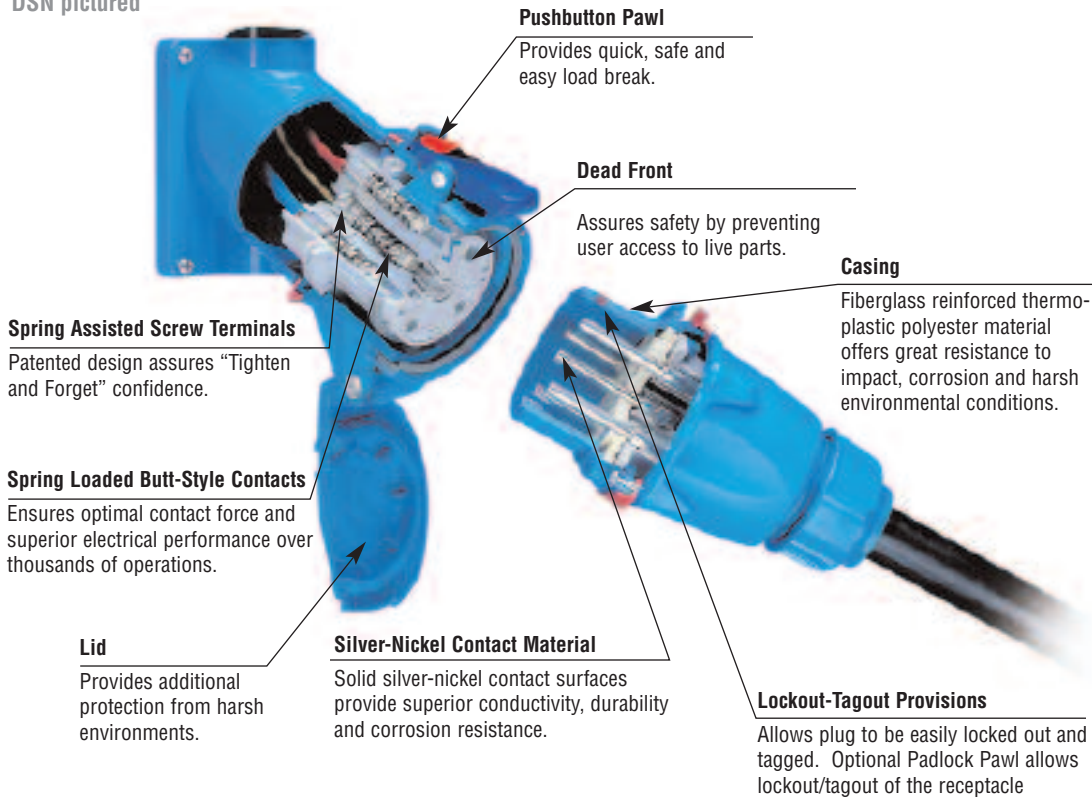

## General Ratings

<b>Amperage</b>	30 to 250A
<b>Voltage</b>	600 VAC, 250 VDC Max
<b>Frequency</b>	50-400 Hz
<b>Short-Circuit (Withstand)</b>	10kA to 100kA*
<b>Environmental</b>	NEMA 3R, IP54/55**
<b>Temperature</b>	min -40°F/max 140°F

\* DR30, 50 and 100 are 100kA; DR150 and 250 are 10kA  
Testing was performed with RK1 current limiting fuses sized at at least 100% of the devices ampacity ratings.

\*\* IP54 rated when receptacle and plug are mated, when not mated receptacle alone is IP55 rated provided that the lid is latched closed.

## Current Interruption Listings

Model	Current Interruption Capabilities
DR30	Not for current interrupting
DR50	For current interrupting up to 250 VAC***
DR100	For current interrupting up to 600 VAC***
DR150	For current interrupting up to 250 VAC***
DR250	Not for current interrupting

\*\*\* Devices rated for current interrupting are not intended for repetitive switching duties.

## Listings

Category	UL	CSA	IEC
Plugs and Receptacles	UL 1682	C22.2 No. 182.1	60309-1

CE ratings available upon request

## Operating Instructions



When the plug and receptacle are latched together, the circuit is connected.

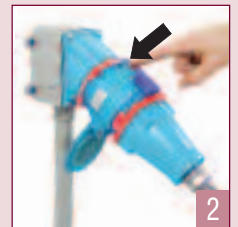

Pressing the pawl causes the DR to break the circuit. The plug is ejected to its rest position; its contacts are now dead.

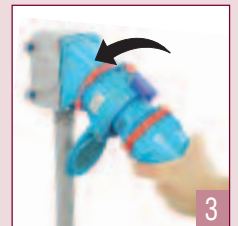

Rotating the 'dead' plug 30° counterclockwise closes the safety shutter and frees the plug to be withdrawn from the receptacle.



The plug and the receptacle are separated. The safety shutter prevents access to live parts.

5 To reconnect, insert plug into receptacle, rotate 30° clockwise, and apply insertion force.



## DR – 30A Standard Duty Plugs & Receptacles

### Ratings

- Voltage**  
600 VAC, 250 VDC
- Current Interruption Capability**  
Not for current interrupting
- Short Circuit Rating**  
100kA  
Testing was performed with RK1 current limiting fuses sized at least 100% of the devices ampacity rating.
- Environmental Ratings**  
NEMA 3R, IP54/55\*  
\* IP54 when the plug & receptacle are mated. IP55 on the receptacle alone when the lid is latched closed.
- Temperature Range**  
Min -40°F/Max 140°F  
See pg 194 for temps below -15°F.
- Wiring Capacity\***  
Min 14 AWG Max 8 AWG  
Aux Contacts - Max 8 AWG  
\*Based on THHN wire sizes
- Listings**  
UL, CSA, IEC, CE\*  
\* Contact Customer Service

### Receptacle (female)



*Don't forget to add installation accessories to your order*

### Inlet (male)

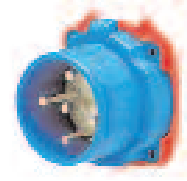

Voltage	Polarity	Part # Poly
120/208V	3P+N+E	31-14237-K16
125V	1P+N+E	31-14175-K07
125/250V	2P+N+E	31-14176-K07
208V	2P+E	31-14232-K16
208V	3P+E	31-14233-K16
250V	2P+E	31-14172-K07
250V	3P+E	31-14173-K07
277V	1P+N+E	31-14245-K04
277/480V	3P+N+E	31-14247-K04
347/600V	3P+N+E	31-14187-K14
480V	2P+E	31-14242-K04
480V	3P+E	31-14243-K04
600V	2P+E	31-14182-K14
600V	3P+E	31-14183-K14

Voltage	Polarity	Part # Poly
120/208V	3P+N+E	31-18237-K16
125V	1P+N+E	31-18175-K07
125/250V	2P+N+E	31-18176-K07
208V	2P+E	31-18232-K16
208V	3P+E	31-18233-K16
250V	2P+E	31-18172-K07
250V	3P+E	31-18173-K07
277V	1P+N+E	31-18245-K04
277/480V	3P+N+E	31-18247-K04
347/600V	3P+N+E	31-18187-K14
480V	2P+E	31-18242-K04
480V	3P+E	31-18243-K04
600V	2P+E	31-18182-K14
600V	3P+E	31-18183-K14

Other voltage configurations are available – contact customer service at 800.433.7642.

### Main Options



**Auxiliary Contacts**



**Emergency Stop Pawl**



**Padlock Pawl**

### Receptacle Options

### Part #

With 2 Auxiliary/Pilot Contacts	Recept # - 972
LP Watertightness (low pressure)	Recept # - LP
HP Watertightness (high pressure)	Recept # - HP
Emergency Stop Pawl	Recept # - 375
Locking Mushroom Pawl	Recept # - 845
Padlock Pawl	Recept # - 843
Metal Pawl (on poly receptacle)	Recept # - 824
Closed Lid Configuration	Recept # - NC
With Auxiliary Switch	Recept # - 270

### Inlet Options

### Part #

With 2 Auxiliary/Pilot contacts	Inlet # - 972
LP Watertightness (low pressure)	Inlet # - LP
HP Watertightness (high pressure)	Inlet # - HP
With no lockout hole	Inlet # - A155
For Auxiliary Switch	Inlet # - NNF
With Spring-Loaded Cap	Inlet # - 226

#### DR30 Order Example:

To order 2 auxiliary/pilot contacts on an inlet and receptacle add **-972** to the part numbers.

DR30 Inlet 3P+E = 31-18243-K04-**972**

DR30 Receptacle 3P+E = 31-14243-K04-**972**

Appropriate accessory part numbers must also be included on the order.

See pgs 171-180 for detailed information on these options

# Installation Accessories

## Handles



Not NEMA 3R

NPT	Poly Handle	Cable Range	Poly Handle w/Clamp & Bushing	Nylon Handle	Neoprene Handle
1/2"	1PH12	.20 - .83	-	FH111	-
3/4"	1PH34	.32 - .88	-	-	31-111
1"	1PH1	.750 - .875	1PM514	-	-
1 1/4"	1PH114	.875 - 1.000	1PM516	-	-
		1.000 - 1.125	1PM518	-	-
		1.125 - 1.250	1PM520	-	-
		1.250 - 1.375	1PM522	-	-

**Notes:** • Finger draw plates are recommended for easier connector closure on cord to cord assemblies.  
• For available cord grips, see pgs 167-168.

## Angles



Nylon 30° Angle	Metal 30° Angle	Metal Angle FS/FD Box 30°	Metal Straight Adapter
MP2	MA2	MAFS2	MS2

## NPT Guidelines

Cable Range	NPT
.062 - .5	1/2"
.187 - .75	3/4"
.437 - 1.10	1"
.750 - 1.375	1 1/4"

NPT sizes are determined by the cable diameter and third party cord grip.

## Junction Boxes



NPT	Metal Box	Metal Box with Nylon Angle	Poly* Conduit Entry
1/2"	MB312	31-1A053-080-12	MC212
3/4"	MB334	31-1A053-080-34	MC234
1"	MB31	31-1A053-080-1	-
1 1/4"	MB3114	31-1A053-080-114	-

\* For poly devices only

## Miscellaneous Accessories



\* Set of Two (2)



For Male Devices Only



For Male Devices Only



Finger Drawplates	Protective Cap	Padlockable Cap Poly	Inlet Spring-loaded Cap
FDP2	31-1A126	DS1PC	31-1A226

\* Recommended for cord to cord assembly applications, for easier connector closure

## Order Example

A typical order should include an inlet part number, a receptacle part number **AND** the matching handles, angles or other required accessories.

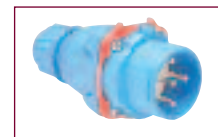

Male Inlet with Handle (Plug)  
31-18243-K04 + FH111



Female Receptacle with Angle Adapter  
31-14243-K04 + MP2



# DR – 50A

## Standard Duty Plugs & Receptacles

### Ratings

- Voltage**  
600 VAC, 250 VDC
- Current Interruption Capability**  
For current interrupting up to 250 VAC
- Short Circuit Rating**  
100kA  
Testing was performed with RK1 current limiting fuses sized at least 100% of the devices ampacity rating.
- Environmental Ratings**  
NEMA 3R, IP54/55\*  
\* IP54 when the plug & receptacle are mated. IP55 on the receptacle alone when the lid is latched closed.
- Temperature Range**  
Min -40°F/Max 140°F  
See pg 194 for temps below -15°F.
- Wiring Capacity\***  
Min 12 AWG Max 4 AWG  
Aux Contacts - Max 12 AWG  
\*Based on THHN wire sizes
- Listings**  
UL, CSA, IEC, CE\*  
\*Contact Customer Service

### Receptacle (female)



Don't forget to add installation accessories to your order

### Inlet (male)

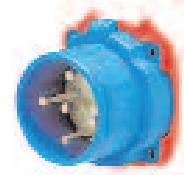

Voltage	Polarity	Part # Poly
120/208V	3P+N+E	31-34237-K16
125V	1P+N+E	31-34175-K07
125/250V	2P+N+E	31-34176-K07
208V	2P+E	31-34232-K16
208V	3P+E	31-34233-K16
250V	2P+E	31-34172-K07
250V	3P+E	31-34173-K07
277V	1P+N+E	31-34245-K04
277/480V	3P+N+E	31-34247-K04
347/600V	3P+N+E	31-34187-K14
480V	2P+E	31-34242-K04
480V	3P+E	31-34243-K04
600V	2P+E	31-34182-K14
600V	3P+E	31-34183-K14

Voltage	Polarity	Part # Poly
120/208V	3P+N+E	31-38237-K16
125V	1P+N+E	31-38175-K07
125/250V	2P+N+E	31-38176-K07
208V	2P+E	31-38232-K16
208V	3P+E	31-38233-K16
250V	2P+E	31-38172-K07
250V	3P+E	31-38173-K07
277V	1P+N+E	31-38245-K04
277/480V	3P+N+E	31-38247-K04
347/600V	3P+N+E	31-38187-K14
480V	2P+E	31-38242-K04
480V	3P+E	31-38243-K04
600V	2P+E	31-38182-K14
600V	3P+E	31-38183-K14

Other voltage configurations are available – contact customer service at 800.433.7642.

### Main Options



Auxiliary Contacts



Emergency Stop Pawl



Padlock Pawl

### Receptacle Options

### Part #

With 2 Auxiliary/Pilot Contacts	Recept # - 972
With 3 Auxiliary/Pilot Contacts	Recept # - 973
With 4 Auxiliary/Pilot Contacts	Recept # - 974
LP Watertightness (low pressure)	Recept # - LP
HP Watertightness (high pressure)	Recept # - HP
Emergency Stop Pawl	Recept # - 375
Locking Mushroom Pawl	Recept # - 845
Padlock Pawl	Recept # - 843
Metal Pawl (on poly receptacle)	Recept # - 824
Closed Lid Configuration	Recept # - NC
With Auxiliary Switch	Recept # - 270
Recess Plate	Recept # - 142

### Inlet Options

### Part #

With 2 Auxiliary/Pilot Contacts	Inlet # - 972
With 3 Auxiliary/Pilot Contacts	Inlet # - 973
With 4 Auxiliary/Pilot Contacts	Inlet # - 974
LP Watertightness (low pressure)	Inlet # - LP
HP Watertightness (high pressure)	Inlet # - HP
With No Lockout Hole	Inlet # - A155
For Auxiliary Switch	Inlet # - NNF
With Spring-Loaded Cap	Inlet # - 226

#### DR50 Order Example:

To order 2 auxiliary/pilot contacts on an inlet and receptacle add **-972** to the part numbers.

DR50 Inlet 3P+E = 31-38243-K04-**972**

DR50 Receptacle 3P+E = 31-34243-K04-**972**

Appropriate accessory part numbers must also be included on the order.

See pgs 171-180 for detailed information on these options

# Installation Accessories

## Handles



Not NEMA 3R

Makes connector closures easier

NPT	Poly Handle	Cable Range	Poly Handle w/Clamp & Bushing	Nylon Handle	Neoprene Handle	Poly Handle w/built in Draw Grip
1/2"	3PH12	.32 - 1.25	-	-	-	FH311-473
3/4"	3PH34	.38 - 1.12	-	-	31-311	-
1"	3PH1	.39 - 1.18	-	FH311	-	-
1 1/4"	3PH114	.750 - .875	3PM514	-	-	-
		.875 - 1.000	3PM516	-	-	-
		1.000 - 1.125	3PM518	-	-	-
		1.125 - 1.250	3PM520	-	-	-
		1.250 - 1.375	3PM522	-	-	-

**Notes:** • For available cord grips, see pgs 167-168.  
• For a guideline of NPT sizes based on cable ranges, see DR30 on pg 132.

## Angles



Nylon 30° Angle	Metal 30° Angle	Metal 70° Angle	Metal Angle FS/FD Box 30°	Metal Straight Adapter
MP3	MA3	89-3A027	MAFS3	MS3

## Junction Boxes



NPT	Metal Box	Metal Box with Nylon Angle	Poly* Conduit Entry
1/2"	MB312	31-3A053-080-12	-
3/4"	MB334	31-3A053-080-34	MC334
1"	MB31	31-3A053-080-1	MC31
1 1/4"	MB3114	31-3A053-080-114	-

\* For poly devices only

## Miscellaneous Accessories



\* Set of Two (2)



For Male Devices Only



For Male Devices Only



Finger Drawplates	Protective Cap	Padlockable Cap Poly	Inlet Spring-Loaded Cap
FDP3	31-3A126	DS3PC	31-3A226

## Accessory Spotlight

### Finger Drawplates



Finger drawplates are recommended for easier connector closure on cord to cord assemblies.

## Order Example

A typical order should include an inlet part number, a receptacle part number **AND** the matching handles, angles or other required accessories.

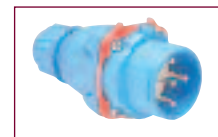

Male Inlet with Handle (Plug)  
31-38243-K04 + FH311



Female Receptacle with Angle Adapter  
31-34243-K04 + MP3



## DR – 100A Standard Duty Plugs & Receptacles

### Ratings

- Voltage**  
600 VAC, 250 VDC
- Current Interruption Capability**  
For current interrupting up to 600 VAC
- Short Circuit Rating**  
100kA  
Testing was performed with RK1 current limiting fuses sized at least 100% of the devices ampacity rating.
- Environmental Ratings**  
NEMA 3R, IP54/55\*  
\* IP54 when the plug & receptacle are mated. IP55 on the receptacle alone when the lid is latched closed.
- Temperature Range**  
Min -40°F/Max 140°F  
See pg 194 for temps below -15°F.
- Wiring Capacity\***  
Min 6 AWG Max 2 AWG  
Aux Contacts - Max 14 AWG  
\* Based on THHN wire sizes
- Listings**  
UL, CSA, IEC, CE\*  
\* Contact Customer Service

### Receptacle (female)



Don't forget to add installation accessories to your order

### Inlet (male)

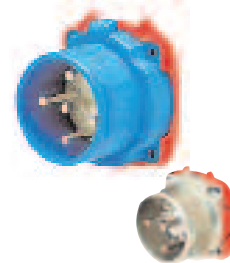

Voltage	Polarity	Part #	
		Poly	Metal
120/208V	3P+N+E	31-64237-K16	39-64237-K16
125V	1P+N+E	31-64175-K07	39-64175-K07
125/250V	2P+N+E	31-64176-K07	39-64176-K07
208V	2P+E	31-64232-K16	39-64232-K16
208V	3P+E	31-64233-K16	39-64233-K16
250V	2P+E	31-64172-K07	39-64172-K07
250V	3P+E	31-64173-K07	39-64173-K07
277V	1P+N+E	31-64245-K04	39-64245-K04
277/480V	3P+N+E	31-64247-K04	39-64247-K04
347/600V	3P+N+E	31-64187-K14	39-64187-K14
480V	2P+E	31-64242-K04	39-64242-K04
480V	3P+E	31-64243-K04	39-64243-K04
600V	2P+E	31-64182-K14	39-64182-K14
600V	3P+E	31-64183-K14	39-64183-K14

Voltage	Polarity	Part #	
		Poly	Metal
120/208V	3P+N+E	31-68237-K16	39-68237-K16
125V	1P+N+E	31-68175-K07	39-68175-K07
125/250V	2P+N+E	31-68176-K07	39-68176-K07
208V	2P+E	31-68232-K16	39-68232-K16
208V	3P+E	31-68233-K16	39-68233-K16
250V	2P+E	31-68172-K07	39-68172-K07
250V	3P+E	31-68173-K07	39-68173-K07
277V	1P+N+E	31-68245-K04	39-68245-K04
277/480V	3P+N+E	31-68247-K04	39-68247-K04
347/600V	3P+N+E	31-68187-K14	39-68187-K14
480V	2P+E	31-68242-K04	39-68242-K04
480V	3P+E	31-68243-K04	39-68243-K04
600V	2P+E	31-68182-K14	39-68182-K14
600V	3P+E	31-68183-K14	39-68183-K14

Other voltage configurations are available – contact customer service at 800.433.7642.

### Main Options



**Auxiliary Contacts**



**Emergency Stop Pawl**



**Padlockable Mushroom Pawl**

### Receptacle Options

### Part #

With 2 Auxiliary/Pilot Contacts	Recept # - 972
With 3 Auxiliary/Pilot Contacts	Recept # - 263
LP Watertightness (low pressure)	Recept # - LP
HP Watertightness (high pressure)	Recept # - HP
Emergency Stop Pawl	Recept # - 375
Locking Mushroom Pawl	Recept # - 845
Padlockable Mushroom Pawl	Recept # - 843
Metal Pawl (on poly receptacle)	Recept # - 824
Closed Lid Configuration	Recept # - NC
With Auxiliary Switch	Recept # - 270
Recess Plate	Recept # - 142

### Inlet Options

### Part #

With 2 Auxiliary/Pilot Contacts	Inlet # - 972
With 3 Auxiliary/Pilot Contacts	Inlet # - 263
LP Watertightness (low pressure)	Inlet # - LP
HP Watertightness (high pressure)	Inlet # - HP
With No Lockout Hole	Inlet # - A155
For Auxiliary Switch	Inlet # - NNF
With Inlet Spring-Loaded Cap	Inlet # - 226

#### DR100 Order Example:

To order 2 auxiliary/pilot contacts on an inlet and receptacle add **-972** to the part numbers.

DR100 Inlet 3P+E = 31-68243-K04-**972**

DR100 Receptacle 3P+E = 31-64243-K04-**972**

Appropriate accessory part numbers must also be included on the order.

See pgs 171-180 for detailed information on these options

# Installation Accessories

Unless indicated otherwise, accessories can be used with either poly or metal plugs and receptacles

## Handles



Not NEMA 3R

Makes connector closures easier

NPT	Poly Handle	Metal* Handle	Cable Range	Poly Handle w/Clamp & Bushing	Nylon Handle	Neoprene Handle	Poly Handle w/built in Draw Grip
1/2"	6PH12	6H12	.50 - 1.25	-	-	31-611	-
3/4"	6PH34	6H34	.51 - 1.38	-	FH611	-	-
1"	6PH1	6H1	.55 - 1.53	-	-	-	FH611-473
1 1/4"	6PH114	6H114	1.250 - 1.375	6PM622	-	-	-
1 1/2"	6PH112	6H112	1.438 - 1.562	6PM625	-	-	-
			1.562 - 1.688	6PM627	-	-	-
			1.688 - 1.812	6PM629	-	-	-

- Notes:**
- For available cord grips, see pgs 167-168.
  - For a guideline of NPT sizes based on cable ranges, see DR250 on pgs 140.
  - \* For metal devices only

## Angles



Nylon 30° Angle	Metal 30° Angle	Metal 70° Angle	Metal Angle Oversized 30°	Metal Straight Adapter	Metal Lateral Angle 30°
MP6	MA6	89-6A027	MA660	MS6	MAB6

## Junction Boxes



NPT	Metal Box	Metal Box with Nylon Angle	Metal Box with Metal Angle	Poly* Conduit Entry
1/2"	-	-	-	MC612
3/4"	-	-	-	MC634
1"	MB61	31-6A053-080-1	39-6A053-080-1	MC61
1 1/4"	MB6114	31-6A053-080-114	39-6A053-080-114	MC6114
1 1/2"	MB6112	31-6A053-080-112	39-6A053-080-112	-
2"	MB62	31-6A053-080-2	39-6A053-080-2	-

\* For poly devices only

## Miscellaneous Accessories



\* Set of Two (2)

For Male Devices Only

For Male Devices Only

Finger Drawplates	Protective Cap	Padlockable Cap Aluminum	Inlet Spring-Loaded Cap
FDP6	31-6A126	DS6MC	31-6A226

## Accessory Spotlight

### Finger Drawplates



Finger drawplates are recommended for easier connector closure on cord to cord assemblies.

## Order Example

A typical order should include an inlet part number, a receptacle part number **AND** the matching handles, angles or other required accessories.

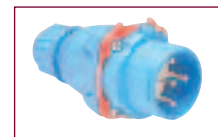

Male Inlet with Handle (Plug)  
31-68243-K04 + FH611



Female Receptacle with Angle Adapter  
31-64243-K04 + MP6





## DR – 150A Standard Duty Plugs & Receptacles

### Ratings

- Voltage**  
600 VAC, 250 VDC
- Current Interruption Capability**  
For current interrupting up to 250 VAC
- Short Circuit Rating**  
10kA  
Testing was performed with RK1 current limiting fuses sized at least 100% of the devices ampacity rating.
- Environmental Ratings**  
NEMA 3R, IP54/55\*  
\* IP54 when the plug & receptacle are mated. IP55 on the receptacle alone when the lid is latched closed.
- Temperature Range**  
Min -40°F/Max 140°F  
See pg 194 for temps below -15°F.
- Wiring Capacity\***  
Min 4 AWG Max 2/0+ AWG  
Aux Contacts - Max 14 AWG  
\* Based on THHN wire sizes  
\* For 2/0 size, add suffix -E323 to inlet or receptacle part number.
- Listings**  
UL, CSA, IEC, CE\*  
\* Contact Customer Service

### Receptacle (female)



### Inlet (male)

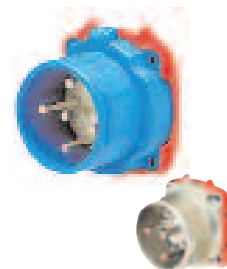

Voltage	Polarity	Part #	
		Poly	Metal
120/208V	3P+N+E	31-94237-K16	39-94237-K16
125V	1P+N+E	31-94175-K07	39-94175-K07
125/250V	2P+N+E	31-94176-K07	39-94176-K07
208V	2P+E	31-94232-K16	39-94232-K16
208V	3P+E	31-94233-K16	39-94233-K16
250V	2P+E	31-94172-K07	39-94172-K07
250V	3P+E	31-94173-K07	39-94173-K07
277V	1P+N+E	31-94245-K04	39-94245-K04
277/480V	3P+N+E	31-94247-K04	39-94247-K04
347/600V	3P+N+E	31-94187-K14	39-94187-K14
480V	2P+E	31-94242-K04	39-94242-K04
480V	3P+E	31-94243-K04	39-94243-K04
600V	2P+E	31-94182-K14	39-94182-K14
600V	3P+E	31-94183-K14	39-94183-K14

Voltage	Polarity	Part #	
		Poly	Metal
120/208V	3P+N+E	31-98237-K16	39-98237-K16
125V	1P+N+E	31-98175-K07	39-98175-K07
125/250V	2P+N+E	31-98176-K07	39-98176-K07
208V	2P+E	31-98232-K16	39-98232-K16
208V	3P+E	31-98233-K16	39-98233-K16
250V	2P+E	31-98172-K07	39-98172-K07
250V	3P+E	31-98173-K07	39-98173-K07
277V	1P+N+E	31-98245-K04	39-98245-K04
277/480V	3P+N+E	31-98247-K04	39-98247-K04
347/600V	3P+N+E	31-98187-K14	39-98187-K14
480V	2P+E	31-98242-K04	39-98242-K04
480V	3P+E	31-98243-K04	39-98243-K04
600V	2P+E	31-98182-K14	39-98182-K14
600V	3P+E	31-98183-K14	39-98183-K14

Other voltage configurations are available – contact customer service at 800.433.7642.

### Main Options



Auxiliary Contacts



Emergency Stop Pawl



Padlockable Mushroom Pawl

### Receptacle Options

### Part #

With 2 Auxiliary/Pilot contacts	Recept # - 172
With 3 Auxiliary/Pilot contacts	Recept # - 173+
With 4 Auxiliary/Pilot contacts	Recept # - 174+
With 5 Auxiliary/Pilot contacts	Recept # - 175+
LP Watertightness (low pressure)	Recept # - LP
HP Watertightness (high pressure)	Recept # - HP
Emergency Stop Pawl	Recept # - 375
Locking Mushroom Pawl	Recept # - 845
Padlockable Mushroom Pawl	Recept # - 843
Metal Pawl (on poly receptacle)	Recept # - 824
180° Opening Lid	Recept # - 180
Closed Lid configuration	Recept # - NC
With Auxiliary Switch	Recept # - 270

### Inlet Options

### Part #

With 2 Auxiliary/Pilot contacts	Inlet # - 172
With 3 Auxiliary/Pilot contacts	Inlet # - 173+
With 4 Auxiliary/Pilot contacts	Inlet # - 174+
With 5 Auxiliary/Pilot contacts	Inlet # - 175+
LP Watertightness (low pressure)	Inlet # - LP
HP Watertightness (high pressure)	Inlet # - HP
With No Lockout Hole	Inlet # - A155
For Auxiliary Switch	Inlet # - NNF

#### DR150 Order Example:

To order 2 auxiliary contacts on an inlet and receptacle add **-972** to the part numbers.

DR150 Inlet 3P+E = 31-98243-K04-172

DR150 Receptacle 3P+E = 31-94243-K04-172

Appropriate accessory part numbers must also be included on the order.

See pgs 171-180 for detailed information on these options

Notes: + DR150 devices with 3 or more auxiliary/pilot contacts are not UL/CSA listed

# Installation Accessories

Unless indicated otherwise, accessories can be used with either poly or metal plugs and receptacles

## Handles



IP 66/67

NPT	Poly Handle	Metal* Handle
3/4"	9PH34	9H34
1"	9PH1	9H1
1 1/4"	9PH114	9H114
1 1/2"	9PH112	9H112
2"	9PH2	9H2

Cable Range	Poly Handle w/Clamp & Bushing	Santoprene™ Handle
.70 - 1.00	–	65-9A013-D25
1.00 - 1.375	–	65-9A013-D35
1.250 - 1.375	9PM622	–
1.375 - 1.750	–	65-9A013-D45
1.438 - 1.562	9PM625	–
1.562 - 1.688	9PM627	–
1.688 - 1.812	9PM629	–

**Notes:** • Finger draw plates are recommended for easier connector closure on cord to cord assemblies.  
 • For available cord grips, see pgs 167-168.  
 \* For metal devices only

• For a guideline of NPT sizes based on cable ranges, see DR250 on pg 140.

## Angles



Nylon 30° Angle	Metal 30° Angle	Metal 70° Angle	Metal Angle Oversized 30°	Metal Straight Adapter
MP10	MA10	89-9A027	MA110	MS10

## Junction Boxes



NPT	Metal Box	Metal Box with Nylon Angle	Metal Box with Metal Angle
1 1/4"	MB10114	31-9A053-080-114	39-9A053-080-114
1 1/2"	MB10112	31-9A053-080-112	39-9A053-080-112
2"	MB102	31-9A053-080-2	39-9A053-080-2
2 1/2"	MB20212	31-9A053-080-212	39-9A053-080-212

## Miscellaneous Accessories



Removable Draw Bar Complete Kit *	1 Draw Bar	1 Plate	Permanently Attached Complete Kit **	1 Draw Bar 1 Attached Plate	1 Plate
NT100	NT110	NT120	39-9A486	39-9A024-486	39-9A014-486

\* Consists of 1 Draw Bar and 2 Plates

\*\* Consists of 1 Draw Bar with Attached Plate and 1 additional Plate



\* Set of Two (2)



For Male Devices Only



For Male Devices Only



Finger Drawplates	Protective Cap	Padlockable Cap Aluminum	Cord Grip with Mesh
FDP9SS	31-9A126	DS9MC	see pgs 167-168

\* Recommended for cord to cord assembly applications, for easier connector closure

## Order Example

A typical order should include an inlet part number, a receptacle part number **AND** the matching handles, angles or other required accessories.



**Male Inlet with Handle (Plug)**  
 39-98243-K04 + 65-9A013-D25



**Female Receptacle with Angle Adapter**  
 39-94243-K04 + MA10



## DR – 250A Standard Duty Plugs & Receptacles

### Ratings

- Voltage**  
600 VAC, 250 VDC
- Current Interruption Capability**  
Not for current interrupting
- Short Circuit Rating**  
10kA  
Testing was performed with RK1 current limiting fuses sized at least 100% of the devices ampacity rating.
- Environmental Ratings**  
NEMA 3R, IP54/55\*  
\* IP54 when the plug & receptacle are mated. IP55 on the receptacle alone when the lid is latched closed.
- Temperature Range**  
Min -40°F/Max 140°F  
See pg 194 for temps below -15°F.
- Wiring Capacity\***  
Min 4 AWG Max 4/0+ AWG  
Aux Contacts - Max 14 AWG  
\* Based on THHN wire sizes  
\* For 4/0 size, add suffix -A06 to inlet or receptacle part number.
- Listings**  
UL, IEC, CE\*  
\* Contact Customer Service

### Receptacle (female)



### Inlet (male)

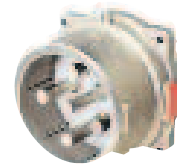

Voltage	Polarity	Part # Metal
120/208V	3P+N+E	39-24237-K16
125V	1P+N+E	39-24035-K07
125/250V	2P+N+E	39-24036-K07
208V	2P+E	39-24232-K16
208V	3P+E	39-24233-K16
250V	2P+E	39-24032-K07
250V	3P+E	39-24033-K07
277V	1P+N+E	39-24245-K04
277/480V	3P+N+E	39-24247-K04
347/600V	3P+N+E	39-24027-K14
480V	2P+E	39-24242-K04
480V	3P+E	39-24243-K04
600V	2P+E	39-24022-K14
600V	3P+E	39-24023-K14

Voltage	Polarity	Part # Metal
120/208V	3P+N+E	39-28237-K16
125V	1P+N+E	39-28035-K07
125/250V	2P+N+E	39-28036-K07
208V	2P+E	39-28232-K16
208V	3P+E	39-28233-K16
250V	2P+E	39-28032-K07
250V	3P+E	39-28033-K07
277V	1P+N+E	39-28245-K04
277/480V	3P+N+E	39-28247-K04
347/600V	3P+N+E	39-28027-K14
480V	2P+E	39-28242-K04
480V	3P+E	39-28243-K04
600V	2P+E	39-28022-K14
600V	3P+E	39-28023-K14

Other voltage configurations are available – contact customer service at 800.433.7642.

### Main Options



**Auxiliary Contacts**



**Emergency Stop Pawl**



**Padlockable Mushroom Pawl**

### Receptacle Options

### Part #

With 2 Auxiliary/Pilot Contacts	Recept # - 172
With 3 Auxiliary/Pilot Contacts	Recept # - 173+
With 4 Auxiliary/Pilot Contacts	Recept # - 174+
With 5 Auxiliary/Pilot Contacts	Recept # - 175+
LP Watertightness (low pressure)	Recept # - LP
HP Watertightness (high pressure)	Recept # - HP
Emergency Stop Pawl	Recept # - 375
Locking Mushroom Pawl	Recept # - 845
Padlockable Mushroom Pawl	Recept # - 843
Metal Pawl (on poly receptacle)	Recept # - 824
180° Opening Lid	Recept # - 180
Closed Lid Configuration	Recept # - NC
With Auxiliary Switch	Recept # - 270

### Inlet Options

### Part #

With 2 Auxiliary/Pilot Contacts	Inlet # - 172
With 3 Auxiliary/Pilot Contacts	Inlet # - 173+
With 4 Auxiliary/Pilot Contacts	Inlet # - 174+
With 5 Auxiliary/Pilot Contacts	Inlet # - 175+
LP Watertightness (low pressure)	Inlet # - LP
HP Watertightness (high pressure)	Inlet # - HP
With No Lockout Hole	Inlet # - A155
For Auxiliary Switch	Inlet # - NNF

#### DR250 Order Example:

To order 2 auxiliary/pilot contacts on an inlet and receptacle add **-172** to the part numbers.

DR250 Inlet 3P+E = 39-28243-K04-**172**

DR250 Receptacle 3P+E = 39-24243-K04-**172**

Appropriate accessory part numbers must also be included on the order.

See pgs 171-180 for detailed information on these options

**Notes:** + DR250 devices with 3 or more auxiliary/pilot contacts are not UL/CSA listed

# Installation Accessories

## Handles



Not NEMA 3R

NPT	Poly Handle	Metal* Handle
1"	-	2H1
1 1/4"	-	2H114
1 1/2"	2PH112	2H112
2"	2PH2	2H2
2 1/2"	2PH212	2H212

Cable Range	Neoprene Handle
1.50 - 2.25	31-211

- Notes:**
- Finger draw plates are recommended for easier connector closure on cord to cord assemblies.
  - For available cord grips, see pgs 167-168.
  - \* For metal devices only

## NPT Guidelines

Cable Range	NPT
.062 - .5	1/2"
.187 - .75	3/4"
.437 - 1.10	1"
.750 - 1.375	1 1/4"
.890 - 1.650	1 1/2"
1.125 - 2.438	2"
1.750 - 2.565	2 1/2"

NPT sizes are determined by the cable diameter and third party cord grip.

## Angles

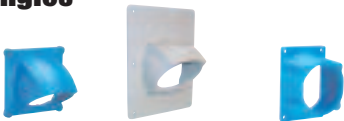

Metal 60° Angle	Metal Angle Oversized 45°	Metal Straight Adapter
MA20	MA220	MS20

## Junction Boxes



NPT	Metal Box	Metal Box with Metal Angle
1 1/2"	MB20112	39-2A053-080-112
2"	MB202	39-2A053-080-2
2 1/2"	MB20212	39-2A053-080-212
Oversized	MB22212	-

## Miscellaneous Accessories

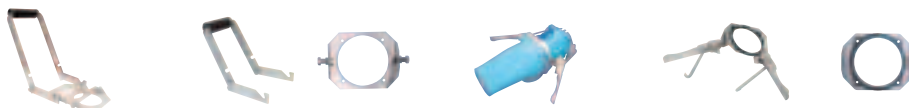

Removable Draw Bar Complete Kit *	1 Draw Bar	1 Plate	Permanently Attached Complete Kit **	1 Draw Bar 1 Attached Plate	1 Plate
NT200	NT210	NT220	39-2A486	39-2A024-486	39-2A014-486

\* Consists of 1 Draw Bar and 2 Plates

\*\* Consists of 1 Draw Bar with Attached Plate and 1 additional Plate



For Male Devices Only



For Male Devices Only



Protective Cap	Padlockable Cap Aluminum	Cord Grip with Mesh
31-2A126	DS2MC	see pgs 167-168

## Order Example

A typical order should include an inlet part number, a receptacle part number **AND** the matching handles, angles or other required accessories.

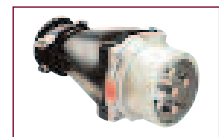

Male Inlet with Handle (Plug)  
39-28247-K04 + 31-211



Female Receptacle with Angle Adapter  
39-24247-K04 + MA20



# Spare Parts Male Configuration

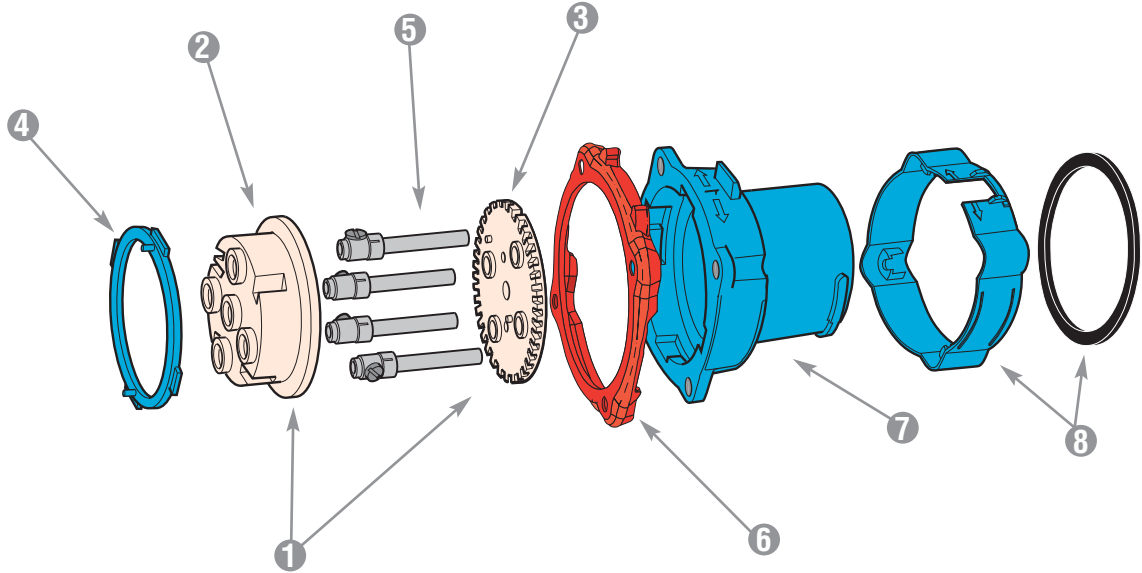

	DR30 POLY	DR50 POLY	DR100 POLY	DR100 METAL	DR150 POLY	DR150 METAL	DR250 METAL
1 = Plug Interior	31-1A010*	31-3A010*	31-6A010*	31-6A010*	31-9A010*	39-9A010*	39-2A010*
1 = Plug Interior with Ground Contacts	-	-	-	39-6A110*	-	39-9A110*	39-2A110*
2 = Interior Bottom	31-1A010-B	31-3A010-B	31-6A010-B	31-6A010-B	31-9A010-B	39-9A010-B	39-2A010-B
3 = Interior Top	31-1A010-T*	31-3A010-T*	31-6A010-T*	31-6A010-T*	31-9A010-T*	39-9A010-T*	39-2A010-T*
4 = Polyester Locking Ring	31-1A583	31-3A583	31-6A583	-	31-9A583	-	-
4 = Metal Locking Ring	-	-	-	39-6A583	-	39-9A583	39-2A583
5 = Plug Contact	31-1A011	31-3A011-380	31-6A011	31-6A011	39-9A011	39-9A011	39-2A011
6 = Color-Coded Voltage Gasket	<div style="display: flex; flex-direction: column; gap: 5px;"> <div><span style="background-color: #0070C0; color: white; border-radius: 50%; padding: 2px 5px;">208V</span> 31-1AB26</div> <div><span style="background-color: #FF9900; color: white; border-radius: 50%; padding: 2px 5px;">250V</span> 31-1AC26</div> <div><span style="background-color: #CC0000; color: white; border-radius: 50%; padding: 2px 5px;">480V</span> 31-1AR26</div> <div><span style="background-color: #333333; color: white; border-radius: 50%; padding: 2px 5px;">600V</span> 31-1AN26</div> <div><span style="background-color: #FF9900; color: white; border-radius: 50%; padding: 2px 5px;">125V</span> 31-1AC26</div> </div>	<div style="display: flex; flex-direction: column; gap: 5px;"> <div>31-3AB26</div> <div>31-3AC26</div> <div>31-3AR26</div> <div>31-3AN26</div> <div>31-3AC26</div> </div>	<div style="display: flex; flex-direction: column; gap: 5px;"> <div>31-6AB26</div> <div>31-6AC26</div> <div>31-6AR26</div> <div>31-6AN26</div> <div>31-6AC26</div> </div>	<div style="display: flex; flex-direction: column; gap: 5px;"> <div>31-6AB26</div> <div>31-6AC26</div> <div>31-6AR26</div> <div>31-6AN26</div> <div>31-6AC26</div> </div>	<div style="display: flex; flex-direction: column; gap: 5px;"> <div>31-9AB26</div> <div>31-9AC26</div> <div>31-9AR26</div> <div>31-9AN26</div> <div>31-9AC26</div> </div>	<div style="display: flex; flex-direction: column; gap: 5px;"> <div>31-9AB26</div> <div>31-9AC26</div> <div>31-9AR26</div> <div>31-9AN26</div> <div>31-9AC26</div> </div>	<div style="display: flex; flex-direction: column; gap: 5px;"> <div>39-2AB26</div> <div>39-2AC26</div> <div>39-2AR26</div> <div>39-2AN26</div> <div>39-2AC26</div> </div>
7 = Plug Polyester Casing	31-1A014**	31-3A014**	31-6A014**	-	31-9A014**	-	-
7 = Plug Metal Casing	-	-	-	39-6A014**	-	39-9A014**	39-2A014**
Ground Ring (Not Shown)	-	-	-	39-6A523	-	39-9A523P	39-2A523
8 = HP Gasket and Ring	31-1A677	31-3A677	39-6A677	39-6A677	-	39-9A677	39-2A677

\* Voltage and phasing positions must be specified (5th, 6th & 7th digit of Part #) to duplicate your shutter and alignment notches.

\*\* For appropriate labeling on a device, please specify voltage, phasing, and product type

# Spare Parts

## Female Configuration

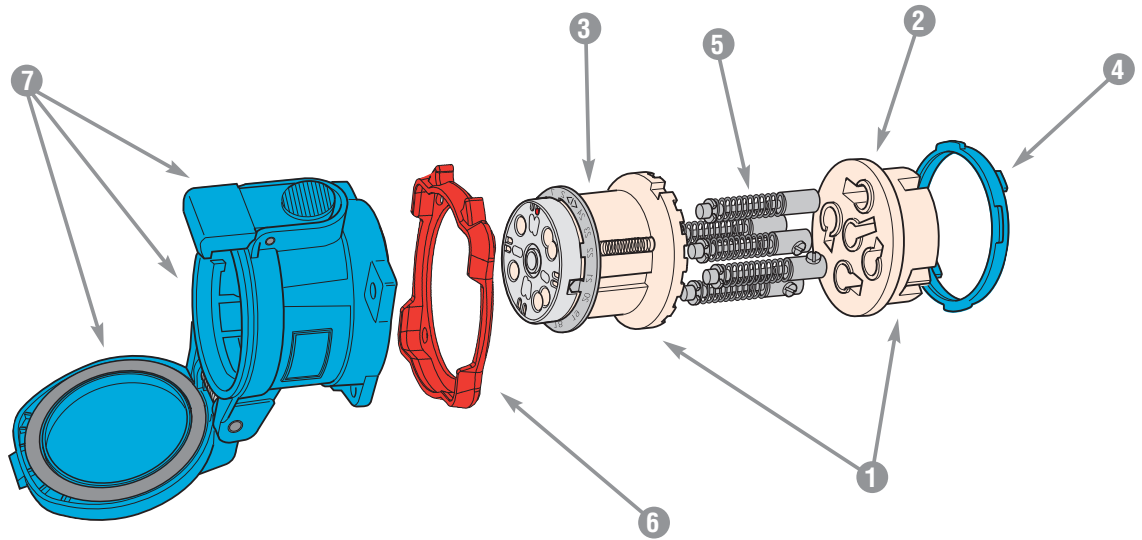

	DR30 POLY	DR50 POLY	DR100 POLY	DR100 METAL	DR150 POLY	DR150 METAL	DR250 METAL	
1 = Receptacle Interior	31-1A020*	31-3A020 *	31-6A020*	31-6A020*	31-9A020*	39-9A020*	39-2A020*	
1 = Receptacle Interior with Ground Contacts	-	-	-	39-6A220*	-	39-9A220*	39-2A220*	
2 = Interior Bottom	31-1A020-B	31-3A020-B	31-6A020-B	31-6A020-B	31-9A020-B	39-9A020-B	39-2A020-B	
3 = Interior Top	31-1A020-T*	31-3A020-T*	31-6A020-T*	31-6A020-T*	31-9A020-T*	39-9A020-T*	39-2A020-T*	
4 = Polyester Locking Ring	31-1A583	31-3A583	31-6A583	-	31-9A583	-	-	
4 = Metal Locking Ring	-	-	-	39-6A583	-	39-9A583	39-2A583	
5 = Receptacle Contact	31-1A021	31-3A021-380	31-6A021	31-6A021	39-9A021	39-9A021	39-2A021	
6 = Color-Coded Voltage Gasket	<div style="display: flex; align-items: center;"> <div style="width: 15px; height: 10px; border-radius: 5px; background-color: #0070C0; margin-right: 5px;"></div> 208V         </div> <div style="display: flex; align-items: center;"> <div style="width: 15px; height: 10px; border-radius: 5px; background-color: #FFA500; margin-right: 5px;"></div> 250V         </div> <div style="display: flex; align-items: center;"> <div style="width: 15px; height: 10px; border-radius: 5px; background-color: #DC143C; margin-right: 5px;"></div> 480V         </div> <div style="display: flex; align-items: center;"> <div style="width: 15px; height: 10px; border-radius: 5px; background-color: #000000; margin-right: 5px;"></div> 600V         </div> <div style="display: flex; align-items: center;"> <div style="width: 15px; height: 10px; border-radius: 5px; background-color: #FFA500; margin-right: 5px;"></div> 125V         </div>	31-1AB26	31-3AB26	31-6AB26	31-6AB26	31-9AB26	31-9AB26	39-2AB26
	31-1AC26	31-3AC26	31-6AC26	31-6AC26	31-9AC26	31-9AC26	39-2AC26	
	31-1AR26	31-3AR26	31-6AR26	31-6AR26	31-9AR26	31-9AR26	39-2AR26	
	31-1AN26	31-3AN26	31-6AN26	31-6AN26	31-9AN26	31-9AN26	39-2AN26	
	31-1AC26	31-3AC26	31-6AC26	31-6AC26	31-9AC26	31-9AC26	39-2AC26	
7 = Receptacle Polyester Casing with Lid	31-1A024**	31-3A024**	31-6A024**	-	31-9A024**	-	-	
7 = Receptacle Metal Casing with Lid	-	-	-	39-6A024**	-	39-9A024**	39-2A024**	
Ground Ring (Not Shown)	-	-	-	39-6A523	-	39-9A523	39-2A523	

\* Voltage and phasing positions must be specified (5th, 6th & 7th digit of Part #) to duplicate your shutter and alignment notches.

\*\* For appropriate labeling on a device, please specify voltage, phasing, and product type

For replacement parts call customer service at 800.433.7642

Courtesy of Gross Automation 1724 South Johnson Road New Berlin, WI PH: 262-446-0000 FAX: 262-446-0300 www.meltricsales.com



# Dimensions

## Inlet – Provided in inches and millimeters

Dimensions are for reference only

### Plug

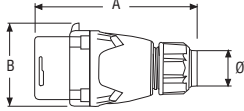

PRODUCT	A	B	Ø
DR30	5.67 144	2.76 70	.32-.90 8-23
DR50	5.83 148	3.23 82	.32-1.25 8-32
DR100/DR7	6.89 175	3.86 98	.55-1.53 14-39
DR150	7.68 195	4.92 125	1.00-1.75 25-45
DR250	10.24 260	5.55 141	1.50-2.25 40-58

### Inlet with connector on/off

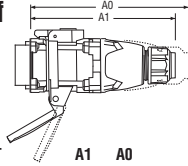

PRODUCT	A1	A0
DR30	6.54 166	7.17 182
DR50	6.85 174	7.48 190
DR100/DR7	7.76 197	8.70 221
DR150	9.69 246	10.83 275
DR250	12.20 310	13.43 341

### Inlet

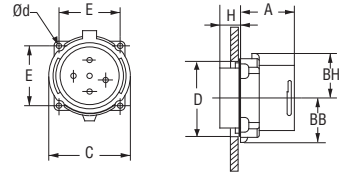

PRODUCT	A	BB	BH	C	D	E	H	Ød
DR30	1.89 48	1.28 32.5	1.46 37	2.62 66.5	2.28 58	1.89 48.1	0.55 14	0.20 5.0
DR50	2.05 52	1.48 37.5	1.75 44.5	3.07 78	2.76 70	2.17 55.1	0.71 18	0.20 5
DR100/DR7	2.20 56	1.77 45	2.09 53	3.62 92	3.15 80	2.59 65.8	1.06 27	0.22 5.5
DR150	2.80 71	2.40 61	2.52 64	4.45 113	3.94 100	3.20 81.3	1.02 26	0.24 6
DR250	3.11 79.0	2.87 73	2.68 68	5.12 130	4.65 118	3.86 98	1.57 40	0.26 6.5

### 30° inclined inlet/angle with connector on/off

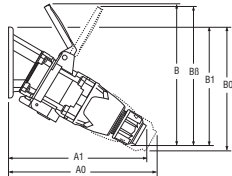

PRODUCT	A1	A0	B	B1	B0	BB
DR30	7.56 192	8.11 206	7.24 184	6.69 170	7.01 178	7.83 199
DR50	7.99 203	8.54 217	8.46 215	7.01 178	7.32 18	8.46 215
DR100/DR7	9.02 229	9.84 250	9.76 248	8.35 212	8.82 224	10.00 254
DR150	11.89 302	12.87 327	12.24 311	9.53 242	10.12 257	
DR250 60°	11.50 292	12.13 308	16.81 427	13.66 347	14.72 374	

### 30° inlet/conduit box

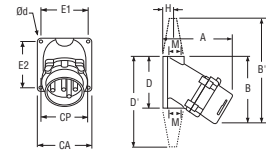

PRODUCT	A	B	CA	CP	D	E1	E2	H	PG	Ød
DR30	4.37 111	4.13 105	3.31 84	2.64 67	3.31 84	2.76 70	2.76 70	0.69 17.5		0.24 6
DR50	5.08 129	4.96 126	3.50 89	2.60 66	3.94 100	3.03 77	3.46 88	0.94 24		0.26 6.5
DR100/DR7 poly	6.69 170	6.22 158	4.13 105	3.62 92	5.04 128	3.50 89	4.41 112	1.22 31	1.25	0.30 7.5

### 30° inclined inlet/angle/junction box with connector on/off

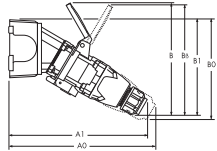

PRODUCT	A1	A0	B	B1	B0	BB
DR30	10.04 255	10.59 269	7.24 184	6.81 173	7.13 181	7.83 199
DR50	10.59 269	11.02 280	8.46 215	7.13 181	7.44 189	8.46 215
DR100/DR7	12.09 307	12.91 328	9.76 248	8.54 217	9.02 229	10.00 254
DR150	15.51 394	16.50 419	12.24 311	9.53 242	10.12 257	
DR250 60°	15.67 398	16.30 414	16.81 427	13.66 347	14.72 374	

### 30° inlet/angle

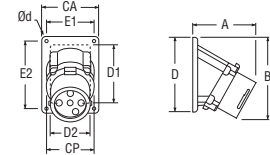

PRODUCT	A	B	CA	CP	D	D1	D2	E1	E2	Ød
DR30	3.62 92	4.49 114	2.99 76	2.64 67	4.21 107	2.56 65	2.44 62	2.48 63	3.74 95	0.22 5.5
DR50	3.94 100	4.72 120	2.99 76	2.60 66	4.21 107	2.56 65	2.68 68	2.48 63	3.74 95	0.22 5.5
DR100/DR7	4.29 109	5.75 146	4.02 102	3.62 92	5.35 136	4.37 111	3.54 90	3.44 87.3	4.80 122	0.26 6.5
DR150	6.02 153	6.26 159	5.51 140	4.45 113	5.59 142	4.33 110	3.94 100	4.87 123.8	0.28 7.0	
DR250 60°	6.93 176	8.90 226	7.20 183	5.12 130	7.20 183	5.91 150	5.91 150	6.50 165	6.50 165	0.28 7.0

### 30° inclined inlet/conduit box with connector on/off

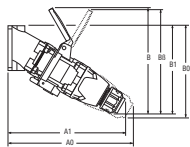

PRODUCT	A1	A0	B	B1	B0	BB
DR30	8.31 211	8.86 225	7.24 184	6.34 161	6.65 169	7.83 199
DR50	9.13 232	9.69 246	8.46 215	7.24 184	7.56 192	8.46 215
DR100/DR7 poly	11.14 283	11.97 304	9.76 248	8.66 220	9.13 232	10.00 254

### inlet/angle/metal junction box

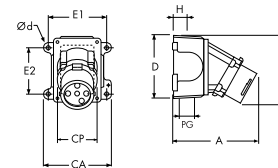

PRODUCT	A	B	CA	CP	D	E1	E2	H	PG	Ød
DR30	6.10 155	4.61 117	4.40 111.8	2.64 67	4.57 116	3.75 95.3	2.78 70.6	1.18 30	1.00	0.25 6.4
DR50	6.42 163	4.84 123	4.40 111.8	2.60 66	4.57 116	3.75 95.3	2.78 70.6	1.18 30	1.00	0.25 6.4
DR100/DR7	7.36 187	5.94 151	5.75 146	3.62 92	5.81 147.5	5.00 127	3.82 97	1.57 40	1.50	0.30 7.5
DR150	9.65 245	6.26 159	7.54 191.5	4.45 113	5.65 143.5	6.62 168.1	4.24 107.7	1.93 49	2.00	0.31 7.8
DR250 60°	11.10 282	8.90 226	8.94 227	5.12 130	7.32 186	8.25 209.6	6.38 162	2.05 52	2.50	0.33 8.4

# Dimensions

## Receptacle – Provided in inches and millimeters

Dimensions are for reference only

### connector

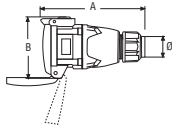

PRODUCT	A	B	Ø
DR30	6.30 160	3.74 95	.32-.90 8-23
DR50	6.50 165	4.25 108	.32-1.25 8-32
DR100/DR7	7.05 179	4.84 123	.55-1.53 14-39
DR150	8.94 227	5.71 145	1.00-1.75 25-45
DR250	11.46 291	6.57 167	1.50-2.25 40-58

### receptacle with plug on/off

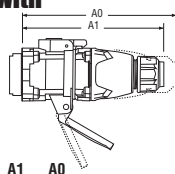

PRODUCT	A1	A0
DR30	6.54 166	7.17 182
DR50	6.85 174	7.48 190
DR100/DR7	7.76 197	8.70 221
DR150	9.69 246	10.83 275
DR250	12.20 310	13.43 341

### receptacle

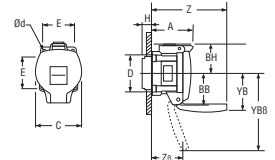

PRODUCT	A	BB	BH	C	D	E	H	YB	YBB	Z	ZB	Ød
DR30	2.56 64.9	1.97 50	1.77 45	2.72 69	2.28 58	1.89 48.1	0.59 15	2.56 65	4.25 108	4.75 120.6	2.99 75.9	0.20 5
DR50	2.70 68.6	2.15 54.5	2.11 53.5	3.15 80	2.76 70	2.17 55.1	0.83 21	3.94 100	5.20 132	4.76 121	2.26 57.5	0.20 5
DR100/DR7	3.00 76.2	2.46 62.5	2.36 60	3.86 98	3.15 80	2.59 65.8	1.06 27	4.33 110	5.98 152	5.76 146.2	3.41 86.7	0.22 5.5
DR150	4.45 113.1	2.95 75	2.76 70	4.45 113	3.94 100	3.20 81.3	0.94 24	5.39 137	7.76 197.1	7.76 197.1	0.24 6	
DR250	4.31 109.5	2.95 75	3.62 92	5.16 131	4.65 118	3.86 98	1.50 38	4.53 115	8.38 212.9	8.38 212.9	0.26 6.5	

### 30° inclined receptacle/angle with plug on/off

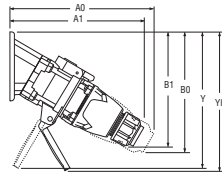

PRODUCT	A1	A0	B1	B0	Y	YB
DR30	7.56 192	8.11 206	6.69 170	7.01 178	7.24 184	7.80 198
DR50	7.99 203	8.54 217	7.01 178	7.32 186	8.27 210	8.27 210
DR100/DR7	9.02 229	9.84 250	8.35 212	8.82 224	10.00 254	10.28 261
DR150	11.89 302	12.87 327	9.53 242	10.12 257	11.77 299	
DR250 60°	11.50 292	12.13 308	13.66 347	14.72 374	11.54 293	

### 30° receptacle/angle

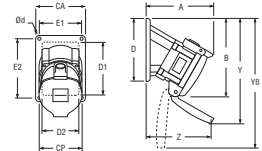

PRODUCT	A	B	CA	CP	D	D1	D2	E1	E2	Y	YB	Z	Ød
DR30	4.57 116	5.39 137	2.99 76	2.72 69	4.21 107	2.56 65	2.44 62	2.48 63	3.74 95	7.24 184	7.80 198	4.29 109	0.22 5.5
DR50	4.92 125	5.71 145	2.99 76	3.15 80	4.21 107	2.56 65	2.68 68	2.48 63	3.74 95	8.27 210	8.27 210	4.29 109	0.22 5.5
DR100/DR7	5.43 138	6.97 177	4.02 102	3.86 98	5.35 136	4.37 111	3.54 90	3.44 87.3	4.80 122	10.00 254	10.28 261	4.49 114	0.26 6.5
DR150	7.87 200	7.80 198	5.51 140	4.45 113	5.59 142	4.33 110	3.94 100	4.87 123.8	4.87 123.8	11.77 299	11.77 299	6.65 169	0.28 7
DR250 60°	8.78 223	9.80 249	7.20 183	5.16 131	7.20 183	5.91 150	5.91 150	6.50 165	6.50 165	14.96 380	14.96 380	3.78 96	0.28 7

### 30° inclined receptacle/conduit box with plug on/off

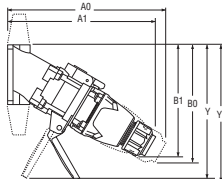

PRODUCT	A1	A0	B1	B0	Y	YB
DR30	8.31 211	8.86 225	6.34 161	6.65 169	6.89 175	7.44 189
DR50	9.13 232	9.69 246	7.24 184	7.56 192	8.50 216	8.50 216
DR100/DR7	11.14 283	11.97 304	8.66 220	9.13 232	10.31 262	10.59 269

### 30° receptacle/conduit box

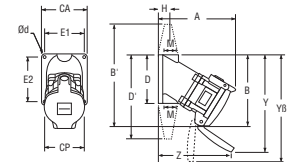

PRODUCT	A	B	CA	CP	D	E1	E2	H	PG	Y	YB	Z	Ød
DR30	5.31 135	5.04 128	3.31 84	2.72 69	3.31 84	2.76 70	2.76 70	0.69 17.5	0.50 12.5	6.89 175	7.44 189	5.04 128	0.24 6
DR50	6.06 154	5.94 151	3.50 89	3.15 80	3.94 100	3.03 77	3.46 88	0.94 24	0.75 19	8.50 216	8.50 216	5.08 129	0.26 6.5
DR100/DR7	7.56 192	7.28 185	4.13 105	3.86 98	5.04 128	3.50 89	4.41 112	1.22 31	1.25 31	10.31 262	10.59 269	6.61 168	0.30 7.5

### 30° inclined receptacle/angle/junction box with plug on/off

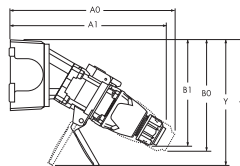

PRODUCT	A1	A0	B1	B0	Y	YB
DR30	10.04 255	10.59 269	6.81 173	7.13 181	7.36 187	7.91 201
DR50	10.47 266	11.02 280	7.13 181	7.44 189	8.39 213	8.39 213
DR100/DR7	12.09 307	12.91 328	8.54 217	9.02 229	10.20 259	10.47 266
DR150	15.51 394	16.50 419	9.53 242	10.12 257	11.77 299	
DR250 60°	15.67 398	16.30 414	13.66 347	14.72 374	11.54 293	

### receptacle/angle/metal junction box

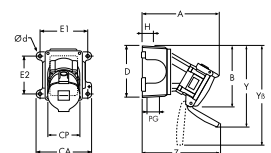

PRODUCT	A	B	CA	CP	D	E1	E2	H	PG	Y	YB	Z	Ød
DR30	7.05 179	5.51 140	4.40 111.8	2.72 69	4.57 116	3.75 95.3	2.78 70.6	1.18 30	1.00 187	7.36 201	7.91 201	6.77 172	0.25 6.4
DR50	7.40 188	5.83 148	4.40 111.8	3.15 80	4.57 116	3.75 95.3	2.78 70.6	1.18 30	1.00 213	8.39 213	8.39 213	6.77 172	0.25 6.4
DR100/DR7	8.50 216	7.17 182	5.75 146	3.86 98	5.81 147.5	5.00 127	3.82 97	1.57 40	1.50 39	10.20 259	10.47 266	7.56 192	0.30 7.5
DR150	11.50 292	7.80 198	7.54 191.5	4.45 113	5.65 143.5	6.62 168.1	4.24 107.7	1.93 49	2.00 299	11.77 299	11.77 299	10.28 261	0.31 7.8
DR250 60°	12.95 329	9.80 249	8.94 227	5.16 131	7.32 186	8.25 209.6	6.38 162	2.05 52	2.50 380	14.96 380	14.96 380	11.89 302	0.33 8.4



Features and Ratings	p. 146
PN20/30	p. 147
PN20/30 High Temp	p. 149
Spare parts	p. 151
Dimensions	p. 153



## Compact plugs and receptacles – standard or high temperature rated

PN Series plugs and receptacles offer superior safety, durability and electrical performance relative to competitive devices. They feature Meltric's spring-loaded, silver-nickel butt contacts in a compact design that is ideal for use on small equipment and other applications where space is limited. PN devices are available with up to IP66 + 67 environmental protection. Available casing materials include glass fiber reinforced polyester (PBT), epoxy coated Zamak and aluminum. The aluminum cased models are designed to withstand high temperatures and can be used in applications up to 365° F.

### Main Advantages

- ▼ Compact yet durable device
- ▼ Spring loaded silver-nickel contacts
- ▼ Spring assisted terminals are unaffected by vibrations and thermal cycling

# Product Features

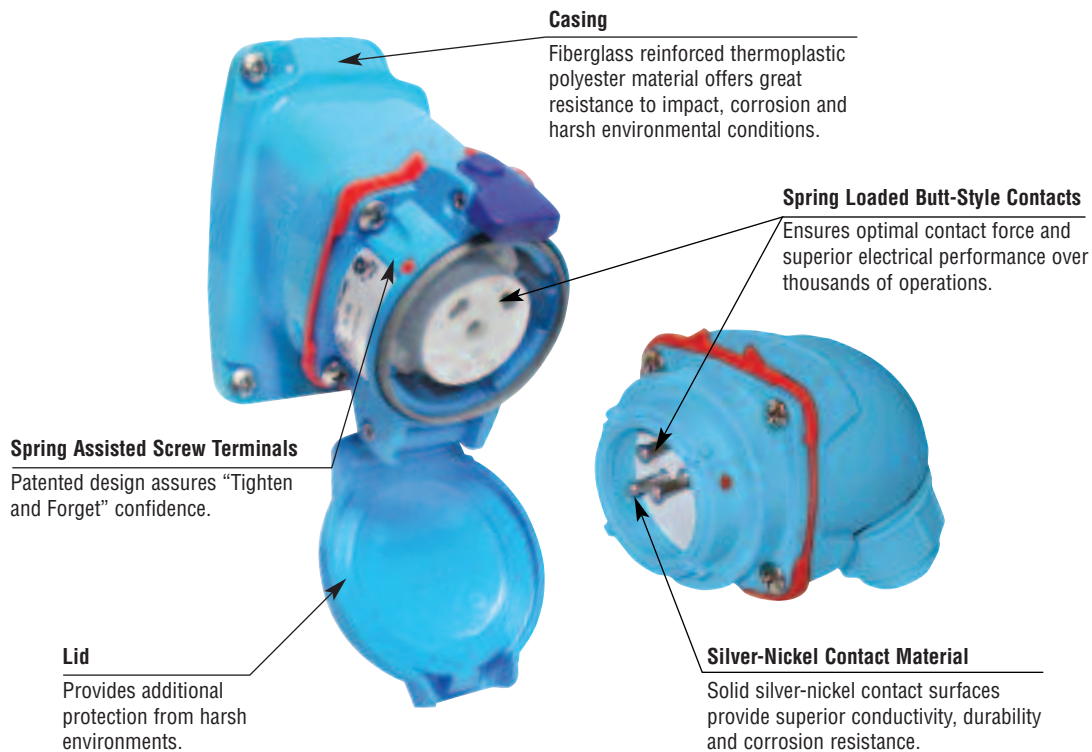

## Operating Instructions



To break the circuit and remove the plug, press the pawl, apply inward force and rotate the plug clockwise.



The plug can be safely withdrawn from the receptacle. The plug contacts remain shrouded until after the circuit is broken.



To reconnect, align the red dots on the plug and receptacle bodies, insert plug into the receptacle, apply insertion force and rotate the plug 20° counterclockwise.

## General Ratings

<b>Amperage</b>	20 to 30A
<b>Voltage</b>	600 VAC Max
<b>Frequency</b>	50-400 Hz
<b>Environmental</b>	NEMA 4X, IP66 + 67
<b>Temperature</b>	min -40°F/max 140°F (365° high temp model)

## Current Interruption Listings

Model	Current interruption capabilities
PN20	For current interrupting
PN30	Not for current interrupting

### Highlighted Feature

#### PN Contact



PN devices feature silver-nickel, spring-loaded, butt-style contacts for superior durability and electrical performance.

## Listings

Category	UL	CSA	IEC
Plugs and Receptacles	UL 1682*	C22.2 No. 182.1*	60309-1

\* PN 20A devices are UL and CSA listed for current interrupting, PN 30A devices are UL listed, non-current interrupting  
PNHT devices are not UL/CSA listed



# Compact – 20A or 30A Standard Duty Plugs & Receptacles

### Ratings

- Voltage**  
600 VAC
- Current Interruption Capability**  
20A Current Interrupting (up to 480 VAC)  
15A Current Interrupting (600 VAC)  
30A Non-Current Interrupting
- Environmental Ratings**  
IP66 + 67\*, IP54/55\*\*  
\* IP66 + 67 provides advanced watertightness for washdown duty applications.  
\*\* IP54 provides rainproof watertightness with ease of connection convenience.
- Temperature Range**  
Min -40°F/Max 140°F  
See pg 194 for temps below -15°F.
- Wiring Capacity**  
Min 18 AWG Max 10 AWG
- Listings**  
UL, CSA, IEC, CE\*  
\* Contact Customer Service

**Notes:** • 600V devices are rated for current interrupting up to 15A only

### Receptacle (female)



Don't forget to add installation accessories to your order

### Inlet (male)



**Notes:** • The same male inlet is used for IP66 + 67 or IP 54 watertight ratings.

IP66 + 67 or IP54

Voltage	Polarity	Part #		Part #		Voltage	Polarity	Part #		Part #	
		Poly	Metal	Poly	Metal			Poly	Metal	Poly	Metal
120/208V	3P+N+E	01-N4167	09-N4167	01-S4167	09-S4167	120/208V	3P+N+E	01-N8167	09-N8167		
125V	1P+N+E	01-N4075	09-N4075	01-S4075	09-S4075	125V	1P+N+E	01-N8075	09-N8075		
125/250V	2P+N+E	01-N4076	09-N4076	01-S4076	09-S4076	125/250V	2P+N+E	01-N8076	09-N8076		
208V	2P+E	01-N4162	09-N4162	01-S4162	09-S4162	208V	2P+E	01-N8162	09-N8162		
208V	3P+E	01-N4163	09-N4163	01-S4163	09-S4163	208V	3P+E	01-N8163	09-N8163		
250V	2P+E	01-N4072	09-N4072	01-S4072	09-S4072	250V	2P+E	01-N8072	09-N8072		
250V	3P+E	01-N4073	09-N4073	01-S4073	09-S4073	250V	3P+E	01-N8073	09-N8073		
277V	1P+N+E	01-N4045	09-N4045	01-S4045	09-S4045	277V	1P+N+E	01-N8045	09-N8045		
277/480V	3P+N+E	01-N4047	09-N4047	01-S4047	09-S4047	277/480V	3P+N+E	01-N8047	09-N8047		
347/600V	3P+N+E	01-N4147	09-N4147	01-S4147	09-S4147	347/600V	3P+N+E	01-N8147	09-N8147		
480V	2P+E	01-N4042	09-N4042	01-S4042	09-S4042	480V	2P+E	01-N8042	09-N8042		
480V	3P+E	01-N4043	09-N4043	01-S4043	09-S4043	480V	3P+E	01-N8043	09-N8043		
600V	2P+E	01-N4142	09-N4142	01-S4142	09-S4142	600V	2P+E	01-N8142	09-N8142		
600V	3P+E	01-N4143	09-N4143	01-S4143	09-S4143	600V	3P+E	01-N8143	09-N8143		

Other voltage configurations are available – contact customer service at 800.433.7642.

### Main Options



See pgs 171-180 for detailed information on these options

### Receptacle Options

Option	Part #
Reverse Interiors	Recept # - 001
With Flush Mount	Recept # - 142
Locking Pawl	Recept # - 824-300
30A Rating	Recept # - 30A

### Inlet Options

Option	Part #
Reverse Interiors	Inlet # - 001
30A Rating	Inlet # - 30A

**Example:**  
To order a device with a reverse interior add **-001** to the inlet and receptacle part numbers.  
PN20 Inlet 3P+E = 01-N4043-**001**  
PN20 Receptacle 3P+E = 01-N8043-**001**  
Appropriate accessory part numbers must also be included on the order.

# Installation Accessories

Unless indicated otherwise, accessories can be used with either poly or metal plugs and receptacles

## Handles



NPT	Poly Handle Threaded Opening	Metal Handle* Threaded Opening	90° Nylon Handle Threaded Opening
1/2"	01-NA013-12	H091U12	04-2A090-5-12
3/4"	01-NA013-34	H091U34	04-2A090-5-34
1"	01-NA013-1	H091U1	04-2A090-5-10

Cable Range	Straight Poly Handle w/Clamp & Bushing	Angled Poly Handle w/Clamp & Bushing
.27 - .75	01-NA013	-
.32 - .67	-	01-NA313

## NPT Guidelines

Cable Range	NPT	Cable Range	NPT
.062 - .5	1/2"	.437 - 1.10	1"
.187 - .75	3/4"	.750 - 1.375	1 1/4"

NPT sizes are determined by the cable diameter and third party cord grip.

**Notes:** \* For available cord grips, see pgs 167-168.  
\* For metal devices only

## Junction Boxes



NPT	Metal Box	Metal Box With Nylon Angle	Metal Box With Metal Angle	Poly Conduit Entry	Poly Straight Wall Box	Metal Straight Wall Box
1/2"	MB312-601*	01-NA053-080-12	09-NA053-080-12	01-NA023-12	01-NA025-12	09-NA025-12
3/4"	MB334-601*	01-NA053-080-34	09-NA053-080-34	01-NA023-34	01-NA025-34	09-NA025-34
1"	MB331-601*	01-NA053-080-1	09-NA053-080-1	-	-	-
1 1/4"	MB3114-601*	01-NA053-080-114	09-NA053-080-114	-	-	-

**Notes:** \* Use with poly angles only

## Angles



Nylon 30° Angle	Metal 45° Angle	Metal Straight Adapter 90°
01-NA027	09-NA027	MSPN

## Miscellaneous Accessories



For Male Devices Only

Protective Cap	Flush Mount
01-NA126	01-2A142

## Order Example

A typical order should include an inlet part number, a receptacle part number **AND** the matching handles, angles or other required accessories.

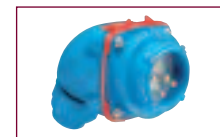

Male Inlet with Handle (Plug)  
01-N8043 + 01-NA313



Female Receptacle with Angle Adapter  
01-N4043 + 01-NA027

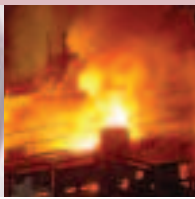

# High Temperature – 20 - 30A Standard Duty Plugs & Receptacles

## Ratings

- **Voltage**  
600VAC, 250VDC
- **Current Interruption Capability**  
PNHT20 Current Interrupting (AC)  
PNHT30 Non-Current Interrupting
- **Environmental Ratings**  
IP44  
\* For additional sealing options contact Customer Service
- **Temperature Range**  
Min -40°F/Max 365°F
- **Wiring Capacity**  
Min 18 AWG Max 10 AWG
- **Listings**  
IEC, CE\*  
\* Contact Customer Service

## Receptacle (female)

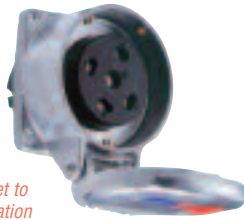

Don't forget to add installation accessories to your order

## Inlet (male)



Voltage	Polarity	Part #	
		20A	30A
250V	1P+N+E	09-24015-185	09-34015-185
250V	2P+E	09-24012-185	09-34012-185
250V	2P+N+E	09-24016-185	09-34016-185
250V	3P+E	09-24013-185	09-34013-185
250V	3P+N+E	09-24017-185	09-34017-185
600V	1P+N+E	09-24035-185	09-34035-185
600V	2P+E	09-24032-185	09-34032-185
600V	3P+E	09-24033-185	09-34033-185
600V	3P+N+E	09-24037-185	09-34037-185

Voltage	Polarity	Part #	
		20A	30A
250V	1P+N+E	09-28015-185	09-38015-185
250V	2P+E	09-28012-185	09-38012-185
250V	2P+N+E	09-28016-185	09-38016-185
250V	3P+E	09-28013-185	09-38013-185
250V	3P+N+E	09-28017-185	09-38017-185
600V	1P+N+E	09-28035-185	09-38035-185
600V	2P+E	09-28032-185	09-38032-185
600V	3P+E	09-28033-185	09-38033-185
600V	3P+N+E	09-28037-185	09-38037-185

Other voltage configurations are available – contact customer service at 800.433.7642.



This high-temperature version of the PN is approved for use in temperatures up to 365°F / 185°C.

Therefore, you can supply power to small pumps and low power motors in location next to heat sources: machines, industrial facilities, steel works, metallurgy, etc.

For temperatures higher than 365°F contact Meltric.

# Installation Accessories

## Handles



NPT	Threaded Opening Metal Handle*
1/2"	H091U12-185
3/4"	H091U34-185
1"	H091U1-185

Cable Range	Metal Handle
.32 - .59	09-2A913-67

## NPT Guidelines

Cable Range	NPT
.062 - .5	1/2"
.187 - .75	3/4"
.437 - 1.10	1"
.750 - 1.375	1 1/4"

NPT sizes are determined by the cable diameter and third party cord grip.

## Angles



Metal 30° Angle	Metal 45° Angle	Metal Straight Adapter
09-2A027-185-404	09-2A027-185	MSPN-185

## Junction Boxes



NPT	Metal Box	Metal Box With Metal Angle	Metal Straight Wall Box
1/2"	MB312-NP	09-NA053-080-12-185	09-2A025-185-12
3/4"	MB334-NP	09-NA053-080-34-185	09-2A025-185-34
1"	MB31-NP	09-NA053-080-1-185	-
1 1/4"	MB314-NP	09-NA053-080-114-185	-

## Order Example

A typical order should include an inlet part number, a receptacle part number **AND** the matching handles, angles or other required accessories.



**Male Inlet with Handle (Plug)**  
09-28017-185 + 09-2A913-67

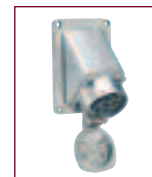

**Female Receptacle with Angle Adapter**  
09-24017-185 + 09-2A027-185

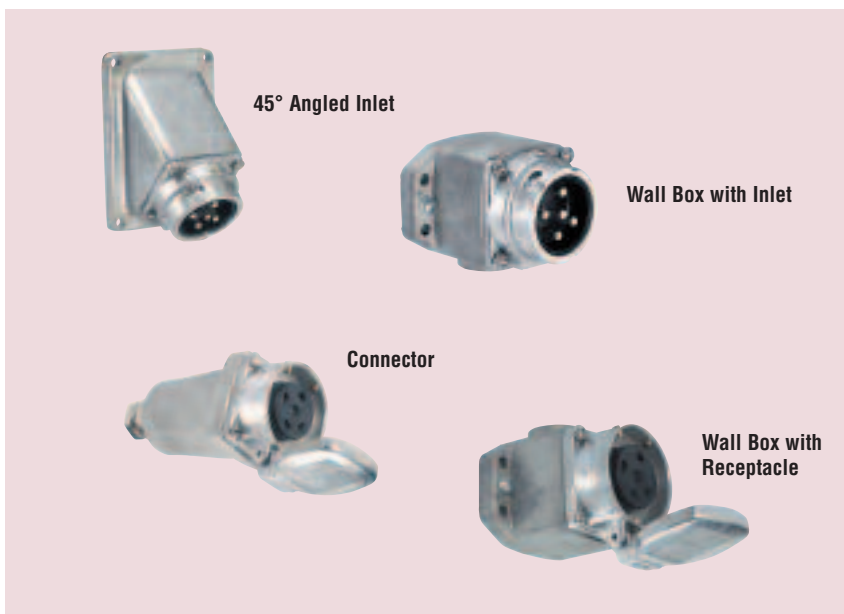

45° Angled Inlet

Wall Box with Inlet





Connector

Wall Box with Receptacle

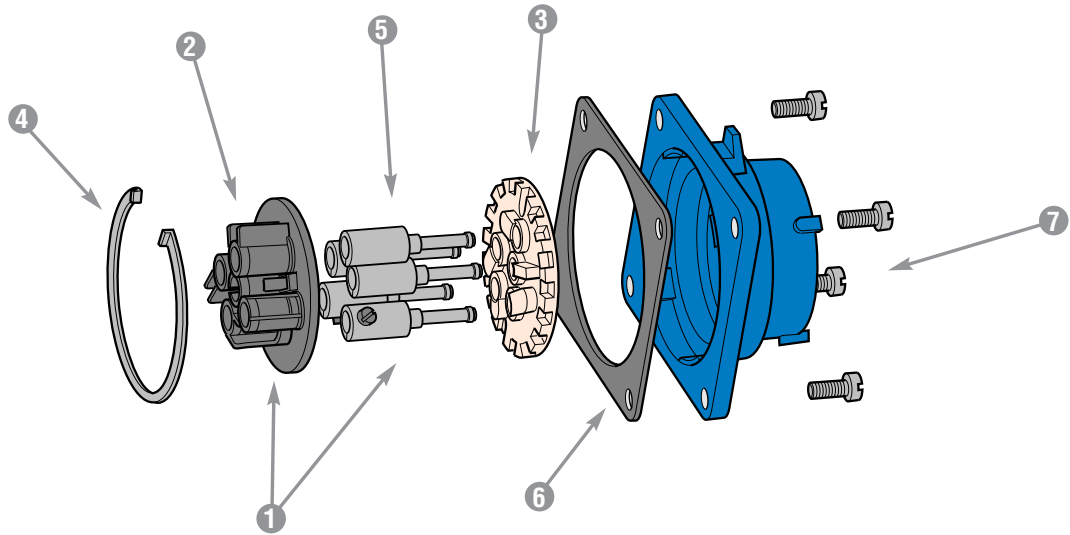

# Spare Parts Male Configuration



	PN20A POLY	PN20A METAL	PN20A HT METAL	PN30A HT METAL
1 = Plug Interior	01-2A010*	01-2A010*	01-2A010-185*	01-2A010-185*
2 = Interior Bottom	01-2A010-B	01-2A010-B	01-2A010-185-B	01-2A010-185-B
3 = Interior Top	01-2A010-T*	01-2A010-T*	01-2A010-185-T*	01-2A010-185-T*
4 = Locking Ring	01-NA583	09-2A583	09-2A583-185	09-2A583-185
5 = Plug Contact	01-2A011	01-2A011	01-2A011-185	01-2A011-185
6 = Device Gasket	 61-1AB26	61-1AB26	-	-
	 61-1AC26	61-1AC26	-	-
	 61-1AR26	61-1AR26	-	-
	 61-1AC26	61-1AC26	-	-
7 = Plug Casing	01-NA014**	09-NA014**	09-2A014-185**	09-2A014-185**





\* Voltage and phasing positions must be specified (5th, 6th & 7th digit of Part #) to duplicate your shutter and alignment notches.

\*\* For appropriate labeling on a device, please specify voltage, phasing, and product type

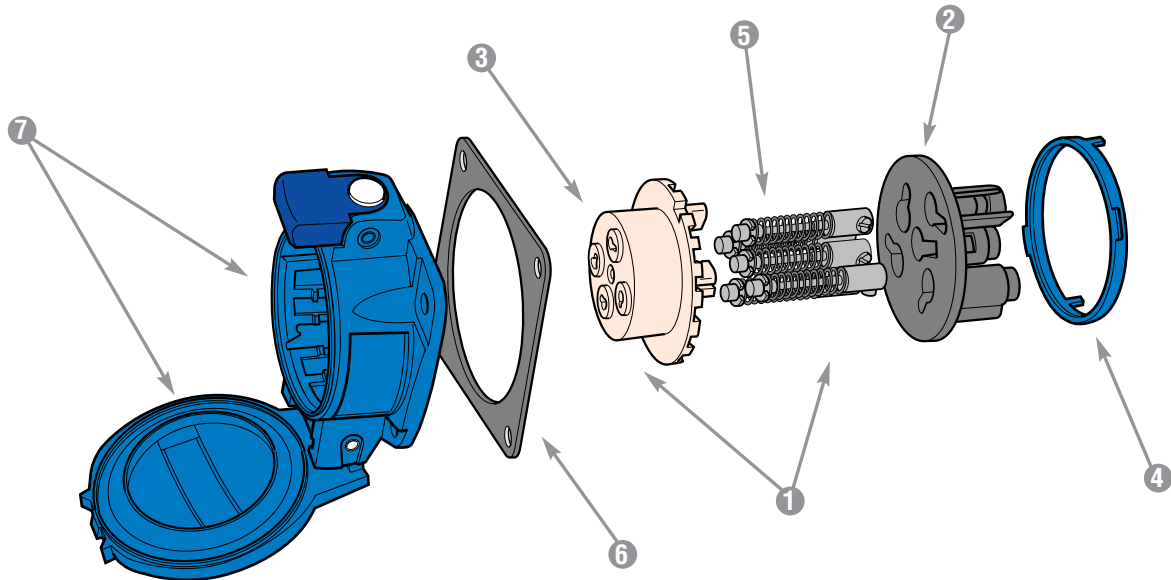
# Spare Parts Female Configuration

PN



	PN20A POLY	PN20A METAL	PN20A HT METAL	PN30A HT METAL
① = Receptacle Interior	01-2A020*	01-2A020*	01-2A020-185*	01-2A020-185*
② = Interior Bottom	01-2A020-B	01-2A020-B	01-2A020-185-B	01-2A020-185-B
③ = Interior Top	01-2A020-T*	01-2A020-T*	01-2A020-185-T*	01-2A020-185-T*
④ = Locking Ring	01-NA583	09-2A583	09-2A583-185	09-2A583-185
⑤ = Receptacle Contact	01-2A021	01-2A021	01-2A021-185	01-2A021-185
⑥ = Device Gasket	 61-1AB26	61-1AB26	-	-
	 61-1AC26	61-1AC26	-	-
	 61-1AR26	61-1AR26	-	-
	 61-1AC26	61-1AC26	-	-
⑦ = Receptacle Casing with Lid IP54/55	01-SA024**	09-SA024**	09-2A024-185**	09-2A024-185**
⑦ = Receptacle Casing with Lid IP66 + 67	01-NA024**	09-NA024**	-	-

\* Voltage and phasing positions must be specified (5th, 6th & 7th digit of Part #) to duplicate your shutter and alignment notches.

\*\* For appropriate labeling on a device, please specify voltage, phasing, and product type

For replacement parts call customer service at 800.433.7642

Courtesy of Gross Automation 1724 South Johnson Road New Berlin, WI PH: 262-446-0000 FAX: 262-446-0300 www.meltricsales.com





# Dimensions

**Inlet** – Provided in inches and millimeters

*Dimensions are for reference only*

## Plug

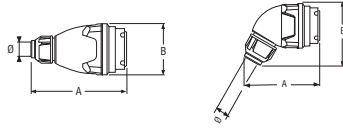

PRODUCT	A	B	Ø
	3.94	2.91	.32-.67
PN/PN7/PN12 angled	100	74	8-17
	4.65	2.28	.32-.59
PN/PN7/PN12 straight	118	58	8-15

## Inlet

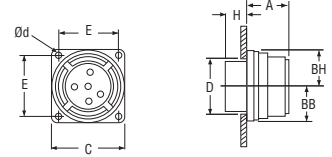

PRODUCT	A	BB	BH	C	D	E	H	Ød
	1.06	1.12	0.98	2.20	1.69	1.65	0.47	0.17
PN/PN7/PN12	27	28.5	28	56	43	41.9	12	4.4

## 30° inclined inlet/angle with connector

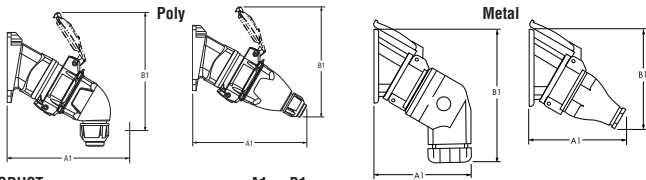

PRODUCT	A1	B1
	4.13	5.75
PN/PN7/PN12 angled poly	105	146
	5.67	4.92
PN/PN7/PN12 straight poly	144	125
	5.43	6.57
PN/PN7/PN12 angled metal	138	167
	4.84	5.43
PN/PN7/PN12 straight metal	123	138

## 30° inlet/angle

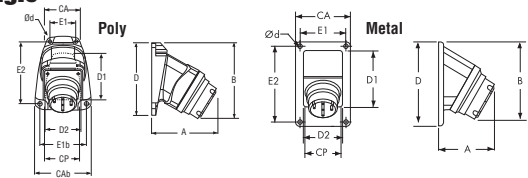

PRODUCT	A	B	CA	CAb	CP	D	D1	D2	E1	E1b	E2	Ød
	2.83	3.43	1.77	2.68	2.24	3.54	2.95	1.97	1.42	2.20	3.07	0.18
PN/PN7/PN12 poly	72	87	45	68	57	90	75	50	36	56	78	4.5
	2.56	4.17	2.99	2.99	1.97	4.21	3.74	2.56	2.48	2.48	3.74	0.24
PN/PN7/PN12 metal	65	106	76	76	50	107	95	65	63	63	95	6

## 30° inclined inlet/angle/junction box with connector

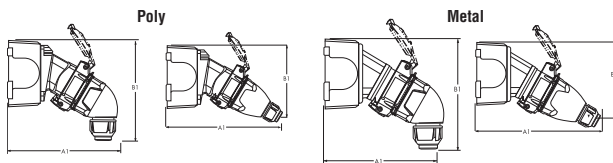

PRODUCT	A1	B1
	7.52	6.30
PN/PN7/PN12 angled poly	191	160
	6.73	5.67
PN/PN7/PN12 straight poly	171	144
	7.91	6.69
PN/PN7/PN12 angled metal	201	170
	7.32	5.55
PN/PN7/PN12 straight metal	186	141

## inlet/angle/metal junction box

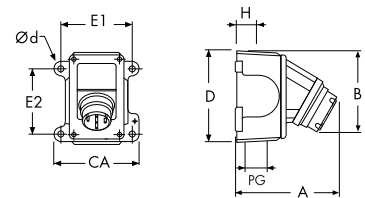

PRODUCT	A	B	CA	D	E1	E2	H	PG	Ød
	4.53	4.06	4.40	4.57	3.75	2.78	1.18	1.00	0.25
PN/PN7/PN12 poly	115	103	111.8	116	95.3	70.6	30	6.4	
	5.04	4.29	4.40	4.57	3.75	2.78	1.18	1.00	0.25
PN/PN7/PN12 metal	128	109	111.8	116	95.3	70.6	30	6.4	

## inlet/straight wall box with connector

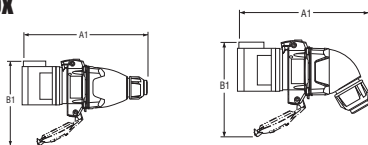

PRODUCT	A1	B1
	6.34	3.58
PN/PN7/PN12 angled	161	91
	6.02	2.76
PN/PN7/PN12 straight	153	70

## inlet/straight wall box

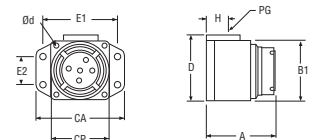

PRODUCT	A	B	CA	CP	D	E1	E2	H	PG	Ød
	2.60	2.17	3.07	2.17	2.40	2.52	0.94	0.69	0.50	0.22
PN/PN7/PN12	66	55	78	55	61	64	24	17.5		5.5

# Dimensions

## Receptacle – Provided in inches and millimeters

Dimensions are for reference only

### connector

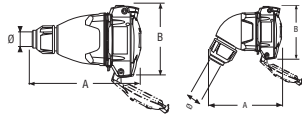

PRODUCT	A	B	Ø
	3.82	3.03	.32-.67
PN/PN7/PN12 angled	97	77	8-17
	4.53	2.99	.32-.59
PN/PN7/PN12 straight	115	76	8-15

### receptacle with plug

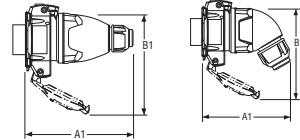

PRODUCT	A1	B1
	4.61	2.99
PN/PN7/PN12 angled	117	76
	4.72	2.99
PN/PN7/PN12 straight	120	76

### receptacle

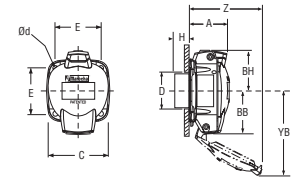

PRODUCT	A	BB	BH	C	D	E	H	YB	Z	Ød
	1.46	1.52	1.41	2.20	1.68	1.65	0.63	3.66	2.66	0.17
PN/PN7/PN12	37	38.5	35.7	56	42.7	42	16	93	67.5	4.4

### 30° inclined receptacle/angle with plug

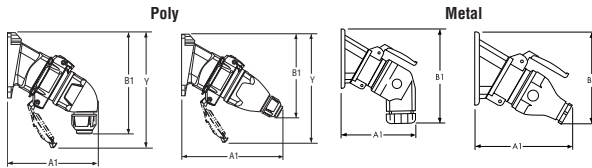

PRODUCT	A1	B1
	4.96	5.59
PN/PN7/PN12 angled poly	126	142
	4.13	5.55
PN/PN7/PN12 straight poly	105	141
	5.43	6.57
PN/PN7/PN12 angled metal	138	167
	4.84	5.43
PN/PN7/PN12 straight metal	123	138

### 30° receptacle/angle

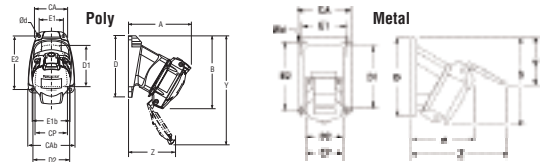

PRODUCT	A	B	CA	CAb	CP	D	D1	D2	E1	E1b	E2	Y	Z	Ød
	3.5	3.97	1.77	2.68	2.24	3.54	2.95	1.97	1.42	2.20	3.07	6.30	1.57	0.18
PN/PN7/PN12 poly	89	101	45	68	57	90	75	50	36	56	78	160	40	4.5
	3.15	4.72	2.99	2.99	2.05	4.21	3.74	2.56	2.48	2.48	3.74	6.38	2.52	0.24
PN/PN7/PN12 metal	80	120	76	76	52	107	95	65	63	63	95	162	64	6

### 30° inclined receptacle/angle/junction box with plug

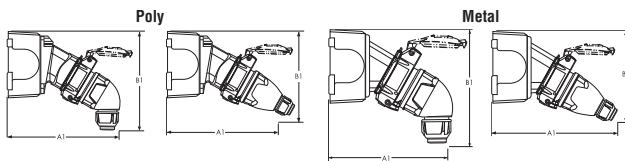

PRODUCT	A1	B1
	7.13	6.30
PN/PN7/PN12 angled poly	181	160
	6.93	5.16
PN/PN7/PN12 straight poly	176	131
	7.91	6.69
PN angled metal	201	170
	7.32	5.55
PN/PN7/PN12 straight metal	186	141

### receptacle/angle/metal junction box

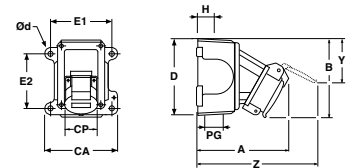

PRODUCT	A	B	CA	CP	D	E1	E2	H	PG	Y	Z	Ød
	5.24	4.45	4.40	2.24	4.57	3.75	2.78	1.18	1.00	6.10	4.61	0.25
PN/PN7/PN12 poly	133	113	111.8	57	116	95.3	70.6	30	155	117	6.4	
	5.63	4.84	4.40	2.05	4.57	3.75	2.78	1.18	1.00	6.50	5.00	0.25
PN/PN7/PN12 metal	143	123	111.8	52	116	95.3	70.6	30	165	127	6.4	

### receptacle/straight wall box with plug

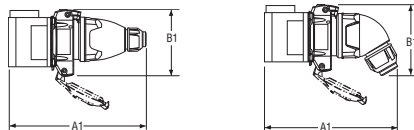

PRODUCT	A1	B1
	5.35	3.11
PN/PN7/PN12 angled	136	79
	6.38	3.01
PN/PN7/PN12 straight	162	76.5

### receptacle/straight wall box

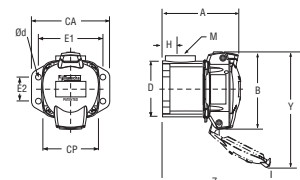

PRODUCT	A	B	CA	CP	D	E1	E2	H	PG	Y	Z	Ød
	2.97	3.00	3.07	2.17	2.39	2.52	0.94	0.69	0.50	5.04	4.49	0.22
PN/PN7/PN12	75.5	76.4	78	55	60.6	64	24	17.5	128	114	5.5	

Custom Power Distribution	p. 157
Disconnect Combinations	p. 159
WS – Welding Connectors	p. 161
LC – Battery Connectors	p. 162
Adapter Plates	p. 163
Cord Grips	p. 167
Voltage/Phase Rotation Meter	p. 169



## Specialty Products

Meltric manufactures a wide variety of specialty products to fit specific application needs and to help users benefit from the advantages of Meltric's switch rated DECONTACTOR™ Series plugs and receptacles where ever connections may need to be made and broken.

### Main Advantages

- ▼ Portable Power Distribution – Provide switch rated safety where ever connections are made
- ▼ Disconnect Combinations – Provide convenience and visual verification of deenergization
- ▼ Backbox Adapter Plates – Simplify replacement of competitive devices with Decontactors
- ▼ Cord Grips – Enhance strain relief and cord gripping
- ▼ WS Single Pole Welding Connectors – Fast and reliable connections
- ▼ LC Battery Connectors – Easy operation with the safety of silver-nickel butt style contacts
- ▼ Voltage/Phase Rotation Meter – Easy means of testing Meltric receptacles for voltage

# Specialty Products



## Custom Power Distribution

Meltric can provide a wide range of power distribution packages built specifically to customer needs.



## Disconnect Combinations

For applications where over current or additional short circuit protection is desired Meltric offers Safety Switch/Receptacle combinations.



## WS - Welding Connectors

For fast connections of welding cables with the reliability of silver-nickel butt style contacts.



## LC - Battery Connectors

Designed to provide quick and easy operation and assure a superior electrical connection in battery charging applications

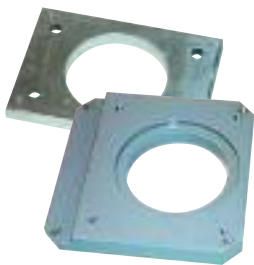

## Adapter Plates

For mounting DECONTACTOR™ receptacles on existing back boxes that were previously used for competitive devices.



## Cord Grips

For inline and other high stress applications where additional cord gripping and strain relief capabilities are beneficial.



## Voltage/Phase Rotation Meter

Provides a simple means of testing receptacles to identify if voltage is available and to determine motor rotation.



# Custom Power Distribution



Custom power solutions from Meltric provide the switch rated safety and durability of Meltric DECONTACTOR™ Series plugs and receptacles in a power distribution package built specifically to customer needs. Whether you require power distribution in a vertical stand configuration, a low profile horizontal configuration, a custom configuration, or as a cordset; Meltric's engineering team can build a package to meet your needs.

**Available Features:**

Input Breaker Protection	Stainless Steel Enclosures	Wheel Kits
NEMA Rated Enclosures	120V Convenience Outlet	Shunt Trips
GFCI Protection	Rain Hoods	Under Voltage Trips
Color Coded Enclosures	Timers	Lifting Provisions
Phase Indication	Pilot Circuits	Power Transformers



**Power / Transformer Assembly**



**Vertical Power**



**Horizontal Multigang**



**Spider Cart Assembly**



**Rubberized Box**



**Portable Panel Assembly**



**Wall Mounted Panel Assembly**



**Cable Assembly**



**Breaker Plate Assembly**

If you don't see what you are looking for, call Meltric @ **800.433.7642**

Courtesy of Gross Automation 1724 South Johnson Road New Berlin, WI PH: 262-446-0000 FAX: 262-446-0300 [www.meltricsales.com](http://www.meltricsales.com)



## Safety Switch / Receptacle Combinations



Meltric's non-interlocked safety switch disconnects are intended for use in power supply applications where additional over current and short circuit protection is desired. Since DECONTACTOR™ Series products are UL and CSA Switch rated, there is no need for the receptacle to be interlocked to the switch. The load may be safely made or broken by throwing the switch lever or by simply connecting or disconnecting the plug.

The standard Meltric Safety Switch Disconnect consists of a DS Series receptacle and angle mounted and wired to a heavy duty, single throw, fusible safety switch. They can optionally be provided with DSN or DB series Decontactors, straight mounting adapters, non-fused switches, or with circuit breaker protection.

### Options:

- DSN Receptacle (DS is standard)
- DB Receptacle
- Straight Adapter (Angle is standard)
- Non-Fused (Fused is standard)
- Transformers
- Reverse Service



## Receptacle / Disconnect Combinations



Meltric's standard offerings use Eaton/Cutler-Hammer safety switches. Other manufacturers switches are available upon request.



Voltage	Polarity	Part #	Part #		Part #		Part #
		30A Poly	60A Poly	60A Metal	100A Poly	100A Metal	200A Metal
208V	2P+E	33-37162-12X	33-67162-12X	37-67162-12X	33-97162-12X	37-97162-12X	37-27162-12X
120/208V	2P+N+E	33-37166-22X	33-67166-22X	37-67166-22X	33-97166-22X	37-97166-22X	37-27166-22X
3Ø/208V	3P+E	33-37163-32X	33-67163-32X	37-67163-32X	33-97163-32X	37-97163-32X	37-27163-32X
120/208V	3P+N+E	33-37167-42X	33-67167-42X	37-67167-42X	33-97167-42X	37-97167-42X	37-27167-42X
250V	2P+E	33-37072-12X	33-67072-12X	37-67072-12X	33-97072-12X	37-97072-12X	37-27072-12X
125/250V	2P+N+E	33-37076-22X	33-67076-22X	37-67076-22X	33-97076-22X	37-97076-22X	37-27076-22X
480V	2P+E	33-37042-12X	33-67042-12X	37-67042-12X	33-97042-12X	37-97042-12X	37-27042-12X
277/480V	2P+N+E	33-37046-22X	33-67046-22X	37-67046-22X	33-97046-22X	37-97046-22X	37-27046-22X
3Ø/480V	3P+E	33-37043-32X	33-67043-32X	37-67043-32X	33-97043-32X	37-97043-32X	37-27043-32X
277/480V	3P+N+E	33-37047-42X	33-67047-42X	37-67047-42X	33-97047-42X	37-97047-42X	37-27047-42X
600V	2P+E	33-37142-12X	33-67142-12X	37-67142-12X	33-97142-12X	37-97142-12X	-
347/600V	2P+N+E	33-37146-22X	33-67146-22X	37-67146-22X	33-97146-22X	37-97146-22X	-
3Ø/600V	3P+E	33-37143-32X	33-67143-32X	37-67143-32X	33-97143-32X	37-97143-32X	-
347/600V	3P+N+E	33-37147-42X	33-67147-42X	37-67147-42X	33-97147-42X	37-97147-42X	-

**Notes:** • When ordering a Safety Switch Disconnect, replace the "X" with the appropriate number that represents the NEMA Rating of choice.

• For higher amperage devices, contact Meltric's Sales Office.

### NEMA Guidelines

X (Number)	NEMA Rating
9	NEMA 4X
7	NEMA 12
5	NEMA 3R
1	NEMA 1

### Ordering Information for Optional Configurations

**DSN Receptacle:** To order a DSN receptacle, change prefix "33" to "63". Example: DSN 60A Poly Receptacle 250V (2P+E) NEMA 1 = **63-67072-121**

**DB Receptacle:** To order a DB receptacle, change prefix "33" or "37" to "89". Example: DB 60A Metal Receptacle 250V (2P+E) NEMA 4X = **89-67072-129**

**Straight Adapter:** To order a straight adapter, add suffix **-S** to the part number. Example: DS 60A Metal Receptacle 480V (3P+E) NEMA 1 = **37-67043-321-S**

**Non-Fused:** To order a non fused device, add suffix **-NF** to the part number. Example: DS 30A Poly Receptacle 250V (2P+E) NEMA 3R = **33-37072-125-NF**





# WS – Welding Connectors

## General Ratings

- **Voltage**  
50 VAC Max
- **Amperage**  
325A Continuous  
500A Intermittent
- **Cable Size**  
250 MCM

WS devices allow users to make fast and reliable connections of welding cables. Their spring-loaded silver contacts provide connections that are unaffected by cable movement or vibration and operate with a self-cleaning wiping action that ensures a reliable electrical connection every time.

Wiring Hole Diameter		Maximum Amperage Cycle (5 min Cycle)		
inches	mm	30% Duty	60% Duty	100% Duty
.25"	6.3	150A	100A	75A
.32"	8.1	200A	125A	100A
.36"	9.1	250A	150A	125A
.43"	10.9	300A	200A	150A
.50"	12.7	350A	250A	200A
.58"	14.7	400A	300A	250A
.62"	15.7	450A	350A	275A
.72"	18.3	500A	450A	325A

*Notes: The chart to the right is a guideline for wiring sizes based on duty cycles.*

## Receptacle (female) Lug Type Connection



Wiring Hole Diameters		Type 2 200A	Type 3 300A	Type 5 500A
(in)	(mm)			
.25"	6.3	4-2401-A	-	-
.32"	8.1	4-2401-B	-	-
.36"	9.1	4-2401-C	-	-
.43"	10.9	4-2401-D	4-3401-E	-
.50"	12.7	-	4-3401-F	-
.58"	14.7	-	4-3401-G	-
.62"	15.7	-	-	4-5401-H
.72"	18.3	-	-	4-5401-J

## Inlet (male) Lug Type Connection



Wiring Hole Diameters		Type 2 200A	Type 3 300A	Type 5 500A
(in)	(mm)			
.25"	6.3	4-2901-A	-	-
.32"	8.1	4-2901-B	-	-
.36"	9.1	4-2901-C	-	-
.43"	10.9	4-2901-D	4-3901-E	-
.50"	12.7	-	4-3901-F	-
.58"	14.7	-	4-3901-G	-
.62"	15.7	-	-	4-5901-H
.72"	18.3	-	-	4-5901-J

## Connector (female) Crimp / Solder Connection



Wiring Hole Diameters		Type 2 200A	Type 3 300A	Type 5 500A
(in)	(mm)			
.25"	6.3	4-2301-A	-	-
.32"	8.1	4-2301-B	-	-
.36"	9.1	4-2301-C	-	-
.43"	10.9	4-2301-D	4-3301-E	-
.50"	12.7	-	4-3301-F	-
.58"	14.7	-	4-3301-G	-
.62"	15.7	-	-	4-5301-H
.72"	18.3	-	-	4-5301-J

## Plug (male) Crimp / Solder Connection



Wiring Hole Diameters		Type 2 200A	Type 3 300A	Type 5 500A
(in)	(mm)			
.25"	6.3	4-0201-A	-	-
.32"	8.1	4-0201-B	-	-
.36"	9.1	4-0201-C	-	-
.43"	10.9	4-0201-D	4-0301-E	-
.50"	12.7	-	4-0301-F	-
.58"	14.7	-	4-0301-G	-
.62"	15.7	-	-	4-0501-H
.72"	18.3	-	-	4-0501-J

The periodic charging of batteries for many applications (including electric boats and material handling vehicles) requires frequent connector operations. In order to avoid current interrupting on the charging contacts, a pilot contact is generally used. The pilot contact is designed to break before the main contacts, thereby signalling the circuit breaker to function.

Meltric's LC battery connectors, are made with spring-loaded, silver-nickel butt style contacts, which are operated by means of a lever. This design ensures a superior electrical connection and the quick and easy operation of the device. The lever also provides a means of locking the units together to help prevent accidental disengagement. By contrast, many competitive battery charger connectors use sliding contacts. Because of how they operate, sliding contacts cannot provide the electrical performance, the durability or the quick breaking capabilities of Meltric's lever operated and spring-loaded, silver-nickel butt contacts.

### General Ratings

- **Voltage**  
50 to 500 VDC Max
- **Current Interruption Capability**  
Not for current interrupting
- **Amperage**  
75A - 200A
- **Cable Termination**  
Crimp/Solder
- **Contact Pressure**  
19.8 lbs Min, 22.0 lbs Max
- **Contact Voltage Drop**  
3.0 mV

## Receptacle (female)



## Plug (male)



Amperage	Wiring Hole Diameters		2P (50V)	2P+15A Pilot (50V)	2P+E+15A Pilot (500V)
	(in)	(mm)			
75A	.25"	6.3	5-2105-A	5-2106-A	5-2107-A
100A	.32"	8.1	5-2105-B	5-2106-B	5-2107-B
125A	.36"	9.1	5-2105-C	5-2106-C	5-2107-C
150A	.43"	10.9	5-2105-D	5-2106-D	5-2107-D
200A	.50"	12.7	5-2105-K	5-2106-K	5-2107-K

Amperage	Wiring Hole Diameters		2P (50V)	2P+15A Pilot (50V)	2P+E+15A Pilot (500V)
	(in)	(mm)			
75A	.25"	6.3	5-0205-A	5-0206-A	5-0207-A
100A	.32"	8.1	5-0205-B	5-0206-B	5-0207-B
125A	.36"	9.1	5-0205-C	5-0206-C	5-0207-C
150A	.43"	10.9	5-0205-D	5-0206-D	5-0207-D
200A	.50"	12.7	5-0205-K	5-0206-K	5-0207-K



## Adapter Plates

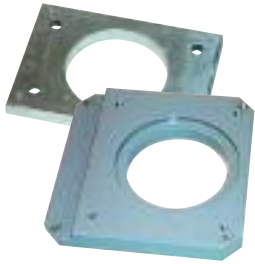

Updating your facility with Decontactor™ Series plugs and receptacles is simple and affordable with Meltric's adapter plates. They allow the mounting of Decontactors to existing boxes previously used for competitive devices. This avoids the cost and hassle of installing new boxes and performing associated re-piping and rewiring. If an adapter plate for the box you have is not listed, contact customer service and Meltric will design a new one to fit your application.

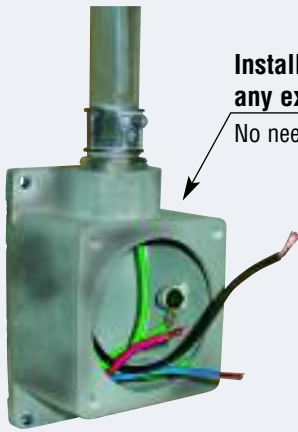

**Install Decontactors on virtually any existing back box**

No need to bend conduit or pull wires



**Meltric Adapter Plates**

Available for hundreds of competitive wall boxes



**Meltric Receptacle**

Meltric Part #	Meltric Devices	Description	Part Numbers Adapted to:		Meltric Part #	Meltric Devices	Description	Part Numbers Adapted to:	
			<b>APPLETON CROUSE-HINDS</b>					<b>APPLETON CROUSE-HINDS</b>	
<b>CHARE36</b>	DS30/DSN60 Recp/Inlet	<i>Appleton and Crouse-Hinds</i>	AEE36	ARE36					ARJG56
			AEE46	ARE46				AR60	
				AEE56	ARE56				AR610
				AERH36	ARRH36				AJ37
				AERH46	ARRH46				AJ47
				AERH56	ARRH56				AJ57
				AERC36	ARRC36				AJ67
				AERC46	ARRC46				AJA6
				AERC56	ARRC56				
				AERA36	ARD36	<b>CHARE56</b>	DS60 Recp/Inlet	<i>Appleton and Crouse-Hinds</i>	AEE36
			AERA46	ARD46					DS100C Recp/Inlet
			AERA56	ARD56				AEE56	ARE56
			AJA310	ARJ36				AERH36	ARRH36
			AJA410	ARJ46				AERH46	ARRH46
			AJA510	ARJ56				AERH56	ARRH56
			AJA610	ARJG36				AERC36	ARRC36
			AJ100	ARJG46				AERC36	ARRC36
							AERC46	ARRC46	



# Adapter Plates



# Adapter Plates

Meltric Part #	Meltric Devices	Description	Part Numbers Adapted to:	Meltric Part #	Meltric Devices	Description	Part Numbers Adapted to:		
			<b>RUSSELL STOLL</b>				<b>HUBBELL</b>		
<b>DSN6JAA6</b>	DSN60 Recp/Inlet	<i>Russell Stoll boxes</i>	JAA6-45	<b>HBL26401</b>	DS30/DSN60 Recp/Inlet	<i>Hubbell / 60/100A Boxes</i>	BB1002W		
			JRAA-AB6			<i>60/100A Boxes</i>	FW60100		
			JE6			<b>HBL26401A</b>	DS3/DSN6 Angle Adapter	<i>Hubbell / 60/100A Boxes</i>	26401
			JAA66			<b>HBL4200</b>	DS200 Receptacle	<i>Hubbell 200A Boxes</i>	4200
			<b>RUSSELL STOLL</b>	<b>HBB26401</b>	DS60 Adapters	<i>Hubbell / 60/100A Boxes</i>	26401		
<b>JRF60</b>	DS60 Recp/Inlet	<i>Russell Stoll boxes</i>	JAA6-AB6	<b>HH50</b>	DS30/DSN60 Recp/Inlet	<i>Hubbelllock / 60A adapters</i>	26402		
	DS100C Recp/Inlet		JAA6-45			<i>60A adapters</i>	26404		
			JRAA-AB6			<b>PNFS</b>	PN/DSN20 Recp/Inlet	<i>FS or FD Single Gang Box</i>	
			JE6						
			JAA66				<b>PYLE-NATIONAL</b>		
<b>PNFS-DSN1-SS</b>	PN/DSN2 Recp/Inlet	<i>FS or FD Single Gang Box</i>		<b>PNFSPL</b>	DS60 Recp/Inlet	<i>Pyle-National / 60A Boxes</i>	JR-26046-A		
<b>PNFS-DSN3-SS</b>	DS/DSN3 Recp/Inlet	<i>FS or FD Single Gang Box</i>			DS100C Recp/Inlet	<i>60A Boxes</i>	JR-36046-A		
			<b>HUBBELL</b>				JR-46046-A		
<b>HH312</b>	MA6	<i>Hubbell / 60/100A Boxes</i>	26401				JR-56046-A		
	MP6		BB601W				JR-336046-C		
	MS6		BB602W				JR-446046-C		
			BB1001W				JR-556046-C		
			BB1002W				JR-26046-BB		
			FW60100				<b>PYLE-NATIONAL</b>		
			<b>HUBBELL</b>				JR-36046-BB		
<b>HH312-E448</b>	DS60 Recp/Inlet	<i>Hubbell / 60/100A Boxes</i>	26401				JR-46046-BB		
	DS100C Recp/Inlet		BB601W				JR-56046-BB		
			BB602W				JR-36046-BE		
			BB1001W				JR-46046-BE		
			BB1002W				JR-56046-BE		
			FW60100				JR-46046-CE		
			<b>KILLARK</b>				JR-56046-CE		
<b>HH60K</b>	DS60 Recp/Inlet	<i>Hubbell-Killark</i>	AJAE				JR-60-J		
	DS100C Recp/Inlet	<i>Hazardous Duty Box</i>	AJAC				JR-64-D		
			AJAT				<b>PYLE-NATIONAL</b>		
<b>MAFS6BA</b>	MA6	<i>FS or FD Single Gang Box</i>		<b>PNJRB30</b>	09-20000-027-80	<i>Pyle-National</i>	JRW-13046-A		
	MP6				MSPN	<i>20/30A Boxes</i>	JRW-23046-A		
	MS6				MP2		JRW-33046-A		
			<b>HUBBELL</b>		MP3		JRW-113046-C		
<b>HHBB201W</b>	DS1/DSN3 Recp/Inlet	<i>Hubbell / 20/30A Boxes</i>	BB201W		MA2		JRW-223046-C		
			BB301W		MA3		JRW-333046-C		
			FT202W		MS2		JR-13046-BB		
			FT302W		MS3		JR-23046-BB		
			<b>HUBBELL</b>				JR-33046-BB		
<b>HBL26401</b>	DS30/DSN60 Recp/Inlet	<i>Hubbell / 60/100A Boxes</i>	26401				JR-43046-BB		
			<i>60/100A Boxes</i>	BB601W			JRW-13046-BE		
				BB602W			JRW-23046-BE		
				BB1001W			JRW-33046-BE		
						JR-23046-CE			

Meltric Part #	Meltric Devices	Description	Part Numbers Adapted to:	Meltric Part #	Meltric Devices	Description	Part Numbers Adapted to:
<b>PNJRBB30</b>			<b>PYLE-NATIONAL</b> JR-33046-CE JR-62-CP				
			<b>PYLE-NATIONAL</b>				
<b>PLN30</b>	09-20000-027-80	<i>Pyle-National / 60A Boxes</i>	JR-26046-A				
	MSPN		JR-36046-A				
	MP2		JR-46046-A				
	MP3		JR-56046-A				
	MA2		JR-336046-C				
	MA3		JR-446046-C				
	MS2		JR-556046-C				
	MS3		JR-26046-BB				
			JR-36046-BB				
			JR-46046-BB				
			JR-56046-BB				
			JR-36046-BE				
			JR-46046-BE				
			JR-56046-BE				
			JR-46046-CE				
			JR-56046-CE				
			JR-60-F				
			JR-64-D				
			<b>PYLE-NATIONAL</b>				
<b>PLN60</b>	MP6	<i>Pyle-National / 60A Boxes</i>	JR-26046-A				
	MA6		JR-36046-A				
	MS6		JR-46046-A				
			JR-56046-A				
			JR-336046-C				
			JR-446046-C				
			JR-556046-C				
			JR-26046-BB				
			JR-36046-BB				
			JR-46046-BB				
			JR-56046-BB				
			JR-36046-BE				
			JR-46046-BE				
			JR-56046-BE				
			JR-46046-CE				
			JR-56046-CE				
			JR-60-F				
			JR-64-D				



## Cord Grips

### Poly Cord Grips



w/Mesh



### Aluminum Cord Grips



w/Mesh

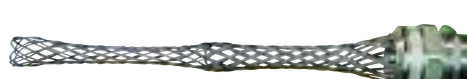

Handle NPT	Cable Range	Part # Cord Grip	Part # Cord Grip w/Mesh
1/2"	.312-.375	CG121P	CG121PM
1/2"	.375-.438	CG122P	CG122PM
3/4"	.438-.562	CG341P	CG341PM
3/4"	.500-.625	CG342P	CG342PM
3/4"	.562-.688	CG343P	CG343PM
3/4"	.625-.750	CG344P	CG344PM
3/4"	.688-.812	CG345P	CG345PM
1"	.660-.780	CG1001P	-
1"	.770-.895	CG1002P	-
1"	.870-1.020	CG1003P	-
1"	.890-1.090	CG1004P	-
1 1/4"	.890-1.090	CG1141P	-
1 1/4"	1.080-1.280	CG1142P	-
1 1/4"	1.270-1.470	CG1143P	-
1 1/4"	-	-	-
1 1/2"	.890-1.150	CG1121P	-
1 1/2"	1.140-1.400	CG1122P	-
1 1/2"	1.390-1.650	CG1123P	-
1 1/2"	-	-	-

Cable Range	Part # Cord Grip	Part # Cord Grip w/Mesh
.312-.375	CG121A	CG121AM
.375-.438	CG122A	CG122AM
.438-.562	CG341A	CG341AM
.500-.625	CG342A	CG342AM
.562-.688	CG343A	CG343AM
.625-.750	CG344A	CG344AM
.688-.812	CG345A	CG345AM
.750-.875	CG1001A	CG1001AM
.812-.938	CG1002A	CG1002AM
-	-	-
-	-	-
.875-1.000	CG1141A	CG1141AM
1.000-1.125	CG1142A	CG1142AM
1.125-1.250	CG1143A	CG1143AM
1.250-1.375	CG1144A	CG1144AM
1.250-1.375	CG1121A	CG1121AM
1.438-1.562	CG1122A	CG1122AM
1.562-1.688	CG1123A	CG1123AM
1.688-1.812	CG1124A	CG1124AM

## Poly Cord Grips



w/Mesh



## Aluminum Cord Grips



w/Mesh

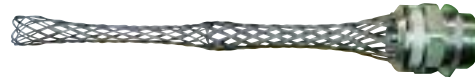

Handle NPT	Cable Range	Part # Cord Grip	Part # Cord Grip w/Mesh
2"	1.190 - 1.530	CG2001P	-
2"	1.520 - 1.860	CG2002P	-
2"	1.850 - 2.190	CG2003P	-
2"	-	-	-
2"	-	-	-
2"	-	-	-
2 1/2"	-	-	-
2 1/2"	-	-	-
2 1/2"	-	-	-

Cable Range	Part # Cord Grip	Part # Cord Grip w/Mesh
1.688 - 1.812	CG2001A	CG2001AM
1.812 - 1.938	CG2002A	CG2002AM
1.938 - 2.062	CG2003A	CG2003AM
2.062 - 2.188	CG2004A	CG2004AM
2.188 - 2.312	CG2005A	CG2005AM
2.312 - 2.438	CG2006A	CG2006AM
2.062 - 2.188	CG2121A	CG2121AM
2.188 - 2.312	CG2122A	CG2122AM
2.312 - 2.438	CG2123A	CG2123AM

## Cable Size Reference Table

Cable Type/Size	Nominal Cable Dia.	Cable Type/Size	Nominal Cable Dia.	Cable Type/Size	Nominal Cable Dia.
16/2 SOW	0.37	8/5 SO	0.92	14/40 SOW	1.55
16/3 SOW	0.39	3/8 W	0.91	3/0 - 2 W	1.67
16/5 SOW	0.51	8/4 W	0.97	3/0 - 3 W	1.77
14/4 SOW	0.58	6/4 W	1.07	2/0 - 4 W	1.81
12/3 SOW	0.62	6/5 W	1.21	1/5 W	1.84
12/4 SOW	0.67	4/4 W	1.27	1/0 - 5 W	1.96
12/5 SOW	0.73	20/12 SOW	1.29	2/0 - 5 W	2.09
10/3 SOW	0.67	14/24 SOW	1.32	4/0 - 4 W	2.10
10/5 SOW	0.80	4/5 W	1.34	3/0 - 5 W	2.24
10/6 SOW	0.88	3/5 W	1.42	4/0 - 5 W	2.40
14/12 SOW	0.91	2/5 W	1.55		



# Phase Rotation Meter



## Voltage / Phase Rotation Meter Assemblies



Voltage/Phase Rotation Meters offer customers an easy means of testing Meltric receptacles for voltage, as well as, motor rotation. The product consists of an inlet and handle wired to the meter. Smaller devices use standard nylon handles, while larger devices are provided with PH handles and cord-grips.

### Order Example

The plug with voltage rotation meter assembly should be ordered to match the receptacles to be tested.



Existing 63-64043 receptacle



Matching plug with voltage phase rotation meter assembly 63-61043-MTR

## Decontactor Inlet and Voltage / Phase Rotation Meter Assemblies DSN Series

Voltage	Polarity	Part # 20A	Part # 30A	Part # 60A
120/208V	3P+N+E	63-11167-MTR	63-31167-MTR	63-61167-MTR
125V	1P+N+E	63-11075-MTR	63-31075-MTR	63-61075-MTR
125/250V	2P+N+E	63-11076-MTR	63-31076-MTR	63-61076-MTR
208V	2P+E	63-11162-MTR	63-31162-MTR	63-61162-MTR
208V	3P+E	63-11163-MTR	63-31163-MTR	63-61163-MTR
250V	2P+E	63-11072-MTR	63-31072-MTR	63-61072-MTR
250V	3P+E	63-11073-MTR	63-31073-MTR	63-61073-MTR
277V	1P+N+E	63-11045-MTR	63-31045-MTR	63-61045-MTR
277/480V	3P+N+E	63-11047-MTR	63-31047-MTR	63-61047-MTR
347/600V	3P+N+E	-	63-31147-MTR	63-61147-MTR
480V	2P+E	63-11042-MTR	63-31042-MTR	63-61042-MTR
480V	3P+E	63-11043-MTR	63-31043-MTR	63-61043-MTR
600V	2P+E	-	63-31142-MTR	63-61142-MTR
600V	3P+E	-	63-31143-MTR	63-61143-MTR

## DS Series

Voltage	Polarity	Part # 20A	Part # 30A	Part # 60A	Part # 100A	Part # 100A	Part # 200A
120/208V	3P+N+E	33-11167-MTR	33-31167-MTR	33-61167-MTR	33-61237-C-K16-MTR	33-91167-MTR	33-21167-MTR
125V	1P+N+E	33-11075-MTR	33-31075-MTR	33-61075-MTR	33-61175-C-K07-MTR	33-91075-MTR	33-21075-MTR
125/250V	2P+N+E	33-11076-MTR	33-31076-MTR	33-61076-MTR	33-61176-C-K07-MTR	33-91076-MTR	33-21076-MTR
208V	2P+E	33-11162-MTR	33-31162-MTR	33-61162-MTR	33-61232-C-K16-MTR	33-91162-MTR	33-21162-MTR
208V	3P+E	33-11163-MTR	33-31163-MTR	33-61163-MTR	33-61233-C-K16-MTR	33-91163-MTR	33-21163-MTR
250V	2P+E	33-11072-MTR	33-31072-MTR	33-61072-MTR	33-61172-C-K07-MTR	33-91072-MTR	33-21072-MTR
250V	3P+E	33-11073-MTR	33-31073-MTR	33-61073-MTR	33-61173-C-K07-MTR	33-91073-MTR	33-21073-MTR
277V	1P+N+E	33-11045-MTR	33-31045-MTR	33-61045-MTR	33-61245-C-K04-MTR	33-91045-MTR	33-21045-MTR
277/480V	3P+N+E	33-11047-MTR	33-31047-MTR	33-61047-MTR	33-61247-C-K04-MTR	33-91047-MTR	33-21047-MTR
347/600V	3P+N+E	33-11147-MTR	33-31147-MTR	33-61147-MTR	33-61187-C-K14-MTR	33-91147-MTR	33-21147-MTR
480V	2P+E	33-11042-MTR	33-31042-MTR	33-61042-MTR	33-61242-C-K04-MTR	33-91042-MTR	33-21042-MTR
480V	3P+E	33-11043-MTR	33-31043-MTR	33-61043-MTR	33-61243-C-K04-MTR	33-91043-MTR	33-21043-MTR
600V	2P+E	33-11142-MTR	33-31142-MTR	33-61142-MTR	33-61182-C-K14-MTR	33-91142-MTR	33-21142-MTR
600V	3P+E	33-11143-MTR	33-31143-MTR	33-61143-MTR	33-61183-C-K14-MTR	33-91143-MTR	33-21143-MTR

## DB Series

Voltage	Polarity	Part # 30A	Part # 60A	Part # 100A
120/208V	3P+N+E	89-31167-MTR	89-61167-MTR	89-91167-MTR
125V	1P+N+E	89-31075-MTR	89-61075-MTR	89-91075-MTR
125/250V	2P+N+E	89-31076-MTR	89-61076-MTR	89-91076-MTR
208V	2P+E	89-31162-MTR	89-61162-MTR	89-91162-MTR
208V	3P+E	89-31163-MTR	89-61163-MTR	89-91163-MTR
250V	2P+E	89-31072-MTR	89-61072-MTR	89-91072-MTR
250V	3P+E	89-31073-MTR	89-61073-MTR	89-91073-MTR
277V	1P+N+E	89-31045-MTR	89-61045-MTR	89-91045-MTR
277/480V	3P+N+E	89-31047-MTR	89-61047-MTR	89-91047-MTR
347/600V	3P+N+E	89-31147-MTR	89-61147-MTR	89-91147-MTR
480V	2P+E	89-31042-MTR	89-61042-MTR	89-91042-MTR
480V	3P+E	89-31043-MTR	89-61043-MTR	89-91043-MTR
600V	2P+E	89-31142-MTR	89-61142-MTR	89-91142-MTR
600V	3P+E	89-31143-MTR	89-61143-MTR	89-91143-MTR

**Notes:** Only the voltage indication function will work for single phase devices. The rotation of the motor can not be determined because only one phase is in use.

Contact customer service for price and availability of inlet and rotation meter assemblies not published here.

# Accessories & Options

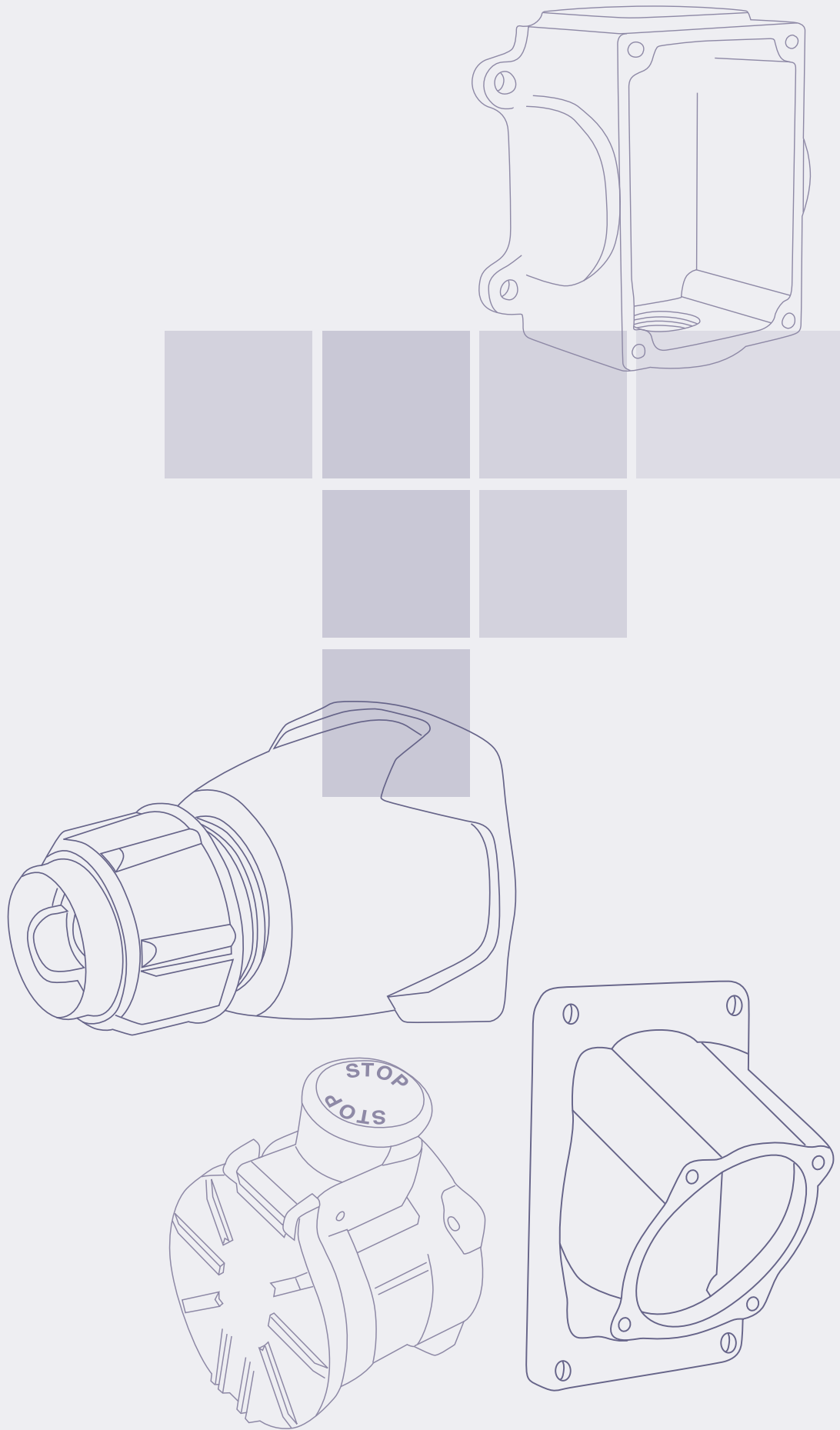



# Accessories & Options

<b>Auxiliary/Pilot Contacts</b>	<b>p. 173</b>
<b>Additional Watertightness</b>	<b>p. 174</b>
<b>Lid Configurations</b>	<b>p. 175</b>
<b>Plug Caps</b>	<b>p. 176</b>
<b>Pawl Options</b>	<b>p. 177</b>
<b>Auxiliary Switches</b>	<b>p. 178</b>
<b>Drawbar Mechanisms</b>	<b>p. 178</b>
<b>Self-Ejecting Devices</b>	<b>p. 179</b>

## Auxiliary / Pilot Contacts

Auxiliary/pilot contacts can operate secondary circuits on the inlet or receptacle side of the circuit. They make last and break first when the plug is engaged or disengaged from the receptacle. To order a device with auxiliary/pilot contacts, add the appropriate suffix numbers listed to the right. Amperage ratings for the auxiliary/pilot contacts depend on the device size and operating voltage (see table below).



Decontactors with auxiliary/pilot contacts can make the operation of a facility safer and more efficient by facilitating the use of advanced control schemes. Decontactors with auxiliary/pilot contacts allow facilities to:

- ▼ **Quickly reconfigure or change-out processing equipment.**  
The need for hard-wiring or multiple plug connections is eliminated.
- ▼ **Reduce equipment costs.**  
The need for separate connections for the auxiliary/pilot contacts is eliminated.
- ▼ **Simplify the monitoring of key parameters.**  
Thermistors on a motor driving a critical process pump can communicate temperature problems via auxiliary/pilot contacts in the Decontactor.
- ▼ **Communicate alarm signals or turn off equipment.**  
When a motor is disconnected or unplugged, the auxiliary/pilot contacts can convey a signal that will de-energize the motor starter.

### Auxiliary Contact Amperage Ratings

Product	120 VAC	240 VAC	480 VAC	600 VAC
DSN30, DSN60	6A	3A	1.5A	1.2A
DS20, DS30, DS60, DS100C	6A	3A	1.5A	1.2A
DS100 and DS200	3A	1.5A	.75A	.6A
DB (All sizes)	6A	3A	1.5A	1.2A
DXN (All sizes)	6A	3A	1.5A	1.2A (550V only)
PF (All sizes)	-	-	10A	10A
PFQ300	-	-	2A	2A
SP	-	-	-	10A

### Ordering Information

To order on a device, add the appropriate suffix to both the inlet and receptacle part numbers.

Product	2 Contacts	3 Contacts	4 Contacts	5 Contacts
DSN30	-972	-	-	-
DSN60	-972	-973	-974	-
DS20	-972	-	-	-
DS30	-972	-973	-974	-
DS60/Poly	-972	-263	-	-
DS60/Metal	-972	-	-	-
DS100C/Poly	-972	-263	-	-
DS100C/Metal	-972	-	-	-
DS100	-172	-173	-174	-175
DS200	-172	-173	-174	-175
DB30	-172	-	-	-
DB60	-172	-	-	-
DB100	-	-	-174	-
DXN30	-972	-	-	-
DXN60	-972	-	-	-
PFQ300	-	-	Standard (8)	-
PF300	-	-	Standard (4)	-
PF400	-	-	Standard (4)	-
PF600	-	-	Standard (4)	-
DR30	-972	-	-	-
DR50	-972	-973	-974	-
DR100/Poly	-972	-263	-	-
DR100/Metal	-972	-	-	-
DR150	-172	-173	-174	-175
DR250	-172	-173	-174	-175
DS7/DR7	-172	-173	-	-
SP	Standard (2)	-	-	-



### Replacement Contacts

Product	Male Pilot	Female Pilot
DSN30	31-1A011-30	31-1A021
DSN60	61-6A011-264	61-6A021-264
DS20	31-1A011-30	31-1A021
DS30	61-6A011-264	61-6A021-264
DR30	31-1A011-30	31-1A021
DR50	61-6A011-264	61-6A021-264

# Additional Watertightness

For additional water protection when the inlet and receptacle are mated the following low pressure or high pressure options may be ordered for DS, DR or DN models.



## Low Pressure

Low pressure waterproofing is used for applications where connectors, plugs, and receptacles are subjected to low water pressure. A gasket is added to the inlet and the receptacle lid is made to normally close.

*Example:*

To order on a device add suffix **-LP** to the inlet and receptacle part number.

*DS20 Poly Inlet 2P + E = 33-18162-LP*

## To Order Separately...

Model	LP Gasket
DS20	31-1A056
DS30	31-3A056
DS60	31-6A066
DS100C	31-6A066
DS100	31-9A066
DS200	39-2A056
DR30	31-1A056
DR50	31-3A056
DR100	31-6A066
DR150	31-6A066
DR250	39-2A056

## High Pressure

High pressure water tightness is used for applications where equipment is subjected to high pressure cleaning and degreasing sprays, or cleaning solution sprays (models DS, DR, and DN only). A gasket and HP ring are added to the inlet and the receptacle lid is made to normally close.

*Example:*

To order on a device add suffix **-HP** to the inlet and receptacle part number.

*DS30 Poly Inlet 3P+E = 33-38163-HP*

Poly handle models PH, PM, and FH are recommended for all high pressure devices.

## To Order Separately...

Model	HP Gasket & Ring	HP Gasket	HP Ring
DS20	31-1A677	31-1A056	39-1A568
DS30	31-3A677	31-3A056	39-3A568
DS60	31-6A677	31-6A066	39-6A568
DS100C	31-6A677	31-6A066	39-6A568
DS100(metal)	31-9A677	-	-
DS100(poly)	-	31-9A066	-
DS200	39-2A677	-	-
DR30	31-1A677	31-1A056	39-1A568
DR50	31-3A677	31-3A056	39-3A568
DR100	31-6A677	31-6A066	39-6A568
DR150	31-9A677*	31-9A066	-
DR250	31-2A677	39-2A056	39-2A568
DN9	-	19-1A016	-
DN20	-	19-6A016	-
DN7(50A)	-	19-3A016	-
DN7(90A)	-	19-6A016	-
DN7(150A)	31-2A677	39-2A056	39-2A568

\*Metal devices only

## Lid Configurations

There are four standard open lid configurations depending on the model and size of the device: 180° open, 120° open, 90° open and detached. Optionally, customers can order lids that are normally closed, or if the lid opens to 120° as standard, it can be ordered to open 180° for flush mounted inlets (DS & DR only).

### Standard Lid Configurations

#### 180° opening lids



**Standard for:**  
 DSN20, DSN30, DSN60  
 DS20, DS30, DS60, DS100C  
 DR30, DR50, DR100

#### 120° Opening Lids



**Standard for:**  
 DX20, DX30, DX60, DX100  
 DXN20, DXN30, DXN60

#### 90° Opening Lids



**Standard for:**  
 DS100, DS200  
 DR150, DR250

#### Detached Lids



**Standard for:**  
 DB30, DB60, DB90  
 PFQ300, PF300, PF400, PF600

### Optional Lid Configurations

#### Closed Lid Configuration

Designed for female devices only. A normally closed lid configuration is available for applications where it is desirable to protect the receptacle face from dust, debris, or potential damage. This option provides a lid that will automatically close to a pre-latch position after removal of the plug. The lid must still be latched manually in order to achieve rated watertightness.



**Available as option on:**  
 DSN (All sizes)  
 DS (All sizes)  
 DR (All sizes)  
 DN (All sizes)

*Examples:*

*To order a DSN, DS, DR, or DN device with a closed lid add **-NC** to the receptacle part number*

*DS20 Poly receptacle 2P + E = 33-14162-NC*

*To order a DXN device with a closed lid add **-R** to the receptacle part number*

*DXN receptacle 2P+E = 22-14162-R*

#### 180° Open Lid for Flush Mounted Inlets (DS, DR & DXN devices only)

When ordering an inlet that will be mounted directly flush against a wall or surface without an angle or box, the connector (receptacle + handle) may require the lid to be set for 180° opening.



**Available as option on:**  
 DS100, DS200  
 DR150, DR250  
 DXN20, DXN30, DXN60

*Example:*

*To order this configuration add suffix **-180** to the receptacle part number*

*DS100 Metal Receptacle 3P+N+E = 37-94047-180*

# Plug Caps

## Protective Neoprene Plug Caps

Neoprene caps provide an extra level of protection from dust, dirt, and rough handling for male plugs.



Typical for DSN, DS, DR, PN and DXN devices



Typical for DB and DN devices

## Ordering Information

Model	Neoprene Plug Cap
DSN20	61-1A126
DSN30	61-3A126
DSN60	61-6A126
DS20	31-1A126
DS30	31-3A126
DS60	31-6A126
DS100C	31-6A126
DS100	31-9A126
DS200	31-2A126
DB30	89-3A126
DB60	89-6A126
DB100	89-9A126
DXN20	22-1A126
DXN30	22-3A126
DXN60	22-6A126
DR30	31-1A126
DR50	31-3A126
DR100	31-6A126
DR150	31-9A126
DR250	31-2A126
DN9	DN16R
DN20	DN63R
DN7 (90A)	DN63R
DN7 (150A)	31-2A126
PN20	01-NA126

## Padlockable Plug Caps

Padlockable caps can be locked in place to prevent unwanted removal.



Typical for: DSN20, DSN30, DSN60  
DS20, DS30, DS60  
DR30, DR50



Typical for: DS60, DS100C, DS100, DS200  
DR100, DR150, DR250

## Ordering Information

Model	Padlockable Plug Cap
DSN20	61-1A826*
DSN30	61-3A826*
DSN60	61-6A826*
DS20	DS1PC (poly)
DS30	DS3PC (poly)
DS60	DS6MC (Alum)
DS100C	DS6MC (Alum)
DS100	DS9MC (Alum)
DS200	DS2MC (Alum)
DB30	-
DB60	-
DB100	-
DXN20	-
DXN30	-
DXN60	-
DR30	DS1PC (poly)
DR50	DS3PC (poly)
DR100	DS6MC (Alum)
DR150	DS9MC (Alum)
DR250	DS2MC (Alum)

\* Maintains IP66 + 67 and NEMA 4X protection



The standard lockout hole is on DSN, DS, DR and DXN plugs is not completely sealed off by the neoprene caps or the DS\_PC and DS\_MC caps. If additional environmental protection is needed while the plug is locked out, the inlet should be ordered without the standard hole.

Example:

To order an inlet without a lockout hole add suffix **-A155** to the inlet part number.

DS20 Poly inlet 2P+E= 33-18162-**A155**



## Pawl Options

### Emergency Stop Pawl

The emergency stop pawl is available as an alternative to the standard pawl. It is ideal for a quick disconnection of motors and other equipment, or in areas where employees use gloves and it is difficult to operate the standard pawls. The button has a red “stop” label for easy recognition.

*Example:*

To order on a receptacle add suffix **-375** to the receptacle part number.

DSN20 poly receptacle 2P+E=63-14162-**375**

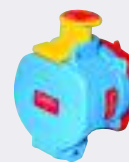

**Available on:**

DSN, DS, DR and DN devices only

### Locking Mushroom Pawl

Locking mushroom pawls are available that include a screw which can be tightened to “lock” the pawl in place thus preventing release of the plug or the lid.

*Example:*

To order on a receptacle add suffix **-845** to the receptacle part number.

DS30 poly receptacle 3P+E =33-34163-**845**



**Available on:**

DSN, DS, DR and DN devices only

### Padlockable Mushroom Pawl

A padlockable mushroom pawl can be provided with a .32” hole that enables the lid to be locked closed, prohibiting access to the receptacle.

*Example:*

To order on a DS, DR or DN receptacle add suffix **-843** to the receptacle part number.

To order on a DSN receptacle add **-375-843** to the receptacle part number.

DS30 poly receptacle 3P+E = 33-38043-**843**



**Available on:**

DSN, DS, DR and DN devices only

**Note:** A 5/16” diameter lock/pin is needed for proper operation. Do not substitute a smaller diameter lock/pin.

### Padlockable Standard Pawl

Standard pawls (DSN only) can be provided with a .32” hole that allows the lid of the receptacle to be locked closed or alternatively the plug can be locked in the connected position.

*Example:*

To order on a receptacle add suffix **-843** to the receptacle part number.

DSN20 poly receptacle 2P+E = 63-14162-**843**



**Available on:**

DSN only

**Note:** A 5/16” diameter lock/pin is needed for proper operation. Do not substitute a smaller diameter lock/pin.

### Metal Pawl

Metal pawls are standard with metal receptacles only. If you prefer a metal pawl on a poly receptacle, add suffix **-824** to the poly receptacle part number. Available on DS and DR devices only.

*Example:*

DS60 poly receptacle 3P+E=33-64163-**824**



**Available on:**

DS and DR devices only

# Auxiliary Switches

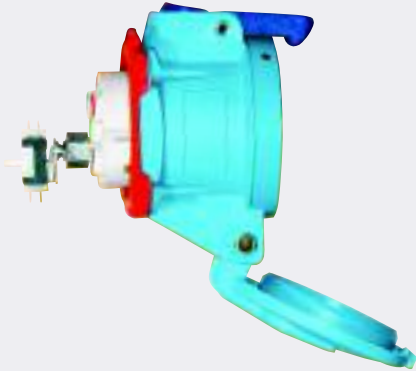

Female receptacles/connectors with up to 3 poles/4 wires are available with an optional auxiliary switch for operating secondary circuits on the line side of the circuit. The auxiliary switch is rated at 5A and includes one set of NO and one set of NC contacts. With the three phase devices the neutral contact of the plug operates the switch which is located in the neutral contact position in the receptacle. With the single phase units the third phase contact on the plug operates the switch which is located in the third phase contact position in the receptacle.

**Auxiliary switches are available on:**

DSN Series – DSN30 and DSN60 only

DS Series – All Sizes

DR Series – All Sizes

Examples:

Order a receptacle with an auxiliary switch by adding suffix **-270** to the receptacle part number

DSN30 Poly Receptacle 3P+E = 63-34043-**270**

If the receptacle is 3 pole/4 wire, the mating plug must be ordered as a 4 pole/5 plus the suffix **-NNF** should be added.

DSN30 Poly Inlet 3P+E = 63-38047-**NNF**

If the receptacle is 2 pole/4 wire (with neutral) the mating plug must be ordered as a 4 pole/5 wire and the suffix **-3NF** must be added.

DSN30 Poly Inlet 2P+N+E =63-38076-**3NF**

## Drawbar Mechanisms

Larger plugs and receptacles typically require more force to engage the plug into the receptacles. For this reason, Meltric offers two styles of drawbar mechanisms to simplify the mating of these devices.

### Removable Drawbar

A removable drawbar is the most economical choice because it may be shared between devices as long as each device is equipped with drawplates on the inlet and receptacle.



A complete kit consists of 1 removable drawbar handle and 2 draw plates, one for the inlet and one for the receptacle.

### Removable Drawbar

Product	Complete Kit	1 Drawbar	1 Plate
DS100	NT100	NT110	NT120
DS200	NT200	NT210	NT220
DR150	NT100	NT110	NT120
DR250	NT200	NT210	NT220
DN20	NT100	NT110	NT120

### Permanent Drawbar

A permanently attached drawbar is the more robust choice.

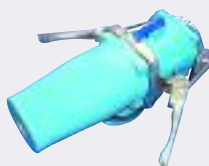

A complete kit consists of 1 drawbar with attached plate plus one additional plate.

### Permanently Attached Drawbar

Product	Complete Kit	1 Drawbar/1 Attached Plate	1 Plate
DS100	39-9A486	39-9A024-486	39-9A014-486
DS200	39-2A486	39-2A024-486	39-2A014-486
DR150	39-9A486	39-9A024-486	39-9A014-486
DR250	39-2A486	39-2A024-486	39-2A014-486
DN20	39-9A486	39-9A024-486	39-9A014-486

## Self-Ejecting Devices

Self-ejecting devices are designed to automatically release the plug or connector when tension is detected, thus protecting the equipment from damage caused when mobile equipment is accidentally moved without disconnecting the power. The self-ejecting system is activated by a tension cord attached between the pawl and power cable.

Applications for the self ejecting option include: truck hook-ups, cranes, railroad cars or portable equipment such as refrigerated food carts.



A tension cord is attached to the power cable and the fin pawl of the plug.



Tension on the power cable will automatically lift the fin pawl via the tension cord.



Once the fin pawl is lifted, the plug pulls away from the receptacle.

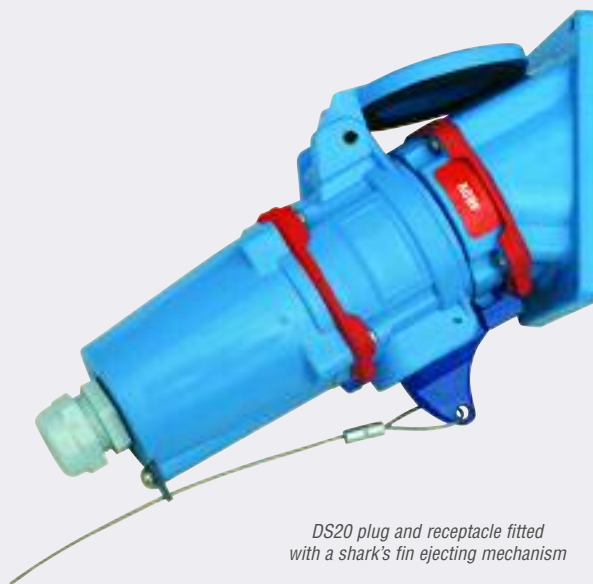

*DS200 plug and receptacle fitted with a shark's fin ejecting mechanism*



*DS200 plug and receptacle fitted with a cam mechanism that ejects the plug when the cable is pulled.*

**WARNING** Weight of cable assemblies can cause damage to units when released and dropped to the ground.

**Notes:** Self-ejecting devices are modified to allow straight insertion. This defeats the safety shutter and voids the devices switch ratings.

## Self-Ejecting Plug



### Principle of Operation:

A cam or shark's fin mechanism is used to lift the pawl on the receptacle thus releasing the plug when a tension is applied to the power cable.

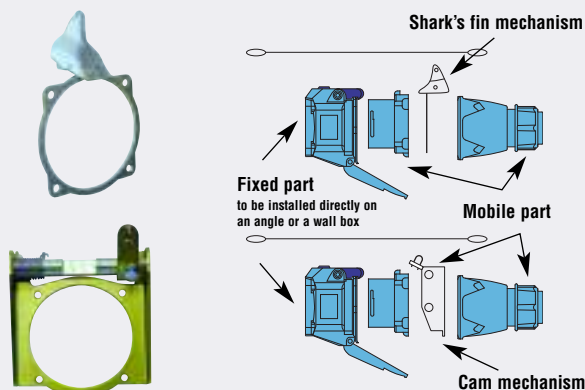

### Sharks fin mechanism is provided on:

DSN20, DSN30, DSN60

DS20, DS30, DS60, DS7

DN7, DN9, DS24, DS37, DSN24, DSN37

### Cam mechanism is provided on:

DS100, DS200

DN9, DN20

### How to Order:

To the male inlet add suffix **-338-A188**

To the female receptacle add suffix **-A188**

To the handle part number add suffix **-CG**

### Example:

To order a 6P DN9/20A with a nylon handle and metal angle, the part numbers would be:

Inlet: 19-18060-**338-A188**

Receptacle (straight insertion): 19-14060-**A188**

Handle: FH311-**CG**

Angle: MA3

### Installation Instructions:

The cable guide plate is to be assembled between the inlet and the back of the handle, with the tension cord threaded through the cable guide plate. Create a slight amount of slack in the power cable, approximately 2' back from the handle. Fasten the tension cord securely to the power cable, making sure the tension cord has less slack than the power cable.

## Self-Ejecting Female Connector



### Principle of Operation:

The standard pawl on the connector is replaced by a "shark's fin" pawl which is attached to the power cable by a tension cord. If the connected equipment is moved, the tension cord lifts the sharks fin pawl and the connector is released before damage can occur.

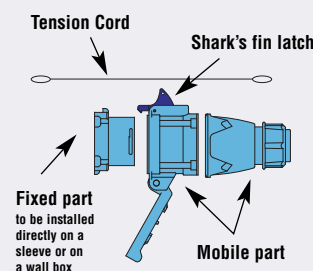

### Available on:

DSN (All sizes)

DS and DR (All sizes)

DN (All sizes)

### How to Order:

To the male inlet add suffix **-A188**

To the female receptacle (DS, DN), add suffix **-348-A188**

To the female receptacle (DSN), add suffix **-345-A188**

To the handle part number add suffix **-CG**

### Example:

To order a 6P DN9/20A with a nylon handle and metal angle, the part numbers would be:

Inlet (straight insertion): 19-18060-**A188**

Receptacle: 19-14060-**348-A188**

Handle: FH311-**CG**

Angle: MA3

### Installation Instructions:

Create a slight amount of slack in the power cable adjacent to the handle. Fasten the tension cord securely to the power cable, making sure the tension cord has less slack than the power cable.

**Notes:** For plug-connector cord sets, it is recommended to order both a self-ejecting plug and a self-ejecting female connector. Do not use finger drawplates in this configuration

# Technical Manual

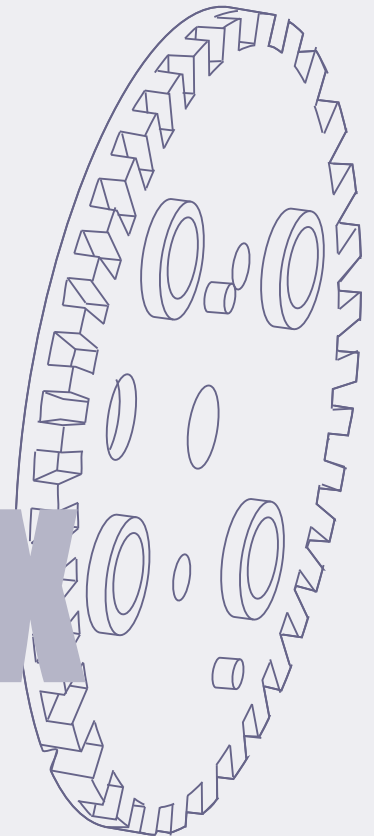
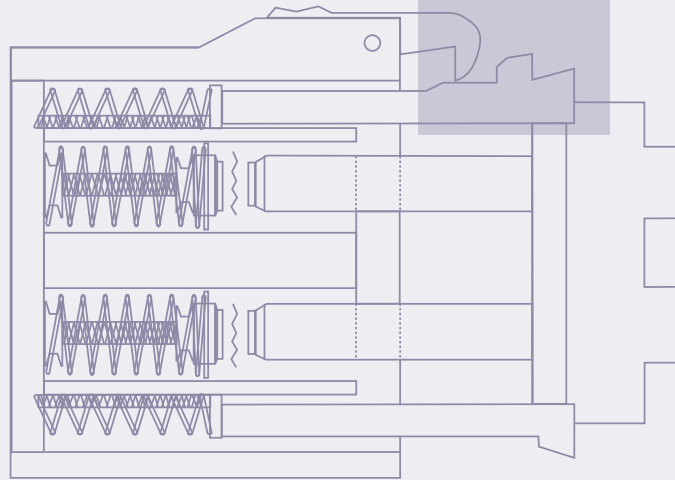
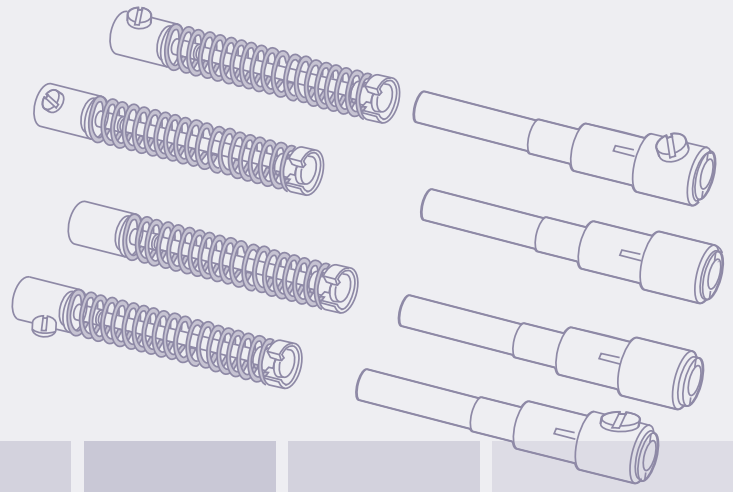

# NEMA 4X



# Technical Manual

<b>Switch Ratings vs Current Interrupting Ratings</b>	<b>p. 183</b>
<b>Electrical Performance</b>	<b>p. 184</b>
<b>Butt-Contact Technology</b>	<b>p. 187</b>
<b>Dead-Front Construction</b>	<b>p. 189</b>
<b>Keying System</b>	<b>p. 190</b>
<b>Dual Voltage Devices</b>	<b>p. 190</b>
<b>Resistance to Environments and Chemicals</b>	<b>p. 191</b>
<b>Watertightness/Ingress Protection</b>	<b>p. 193</b>
<b>Impact Resistance</b>	<b>p. 194</b>
<b>Operating Temperatures</b>	<b>p. 194</b>
<b>Color-Coded Gaskets &amp; Labels</b>	<b>p. 195</b>

# Electrical Performance – Switch Rated, Current Interrupting Rated and Non-Current Interrupting Rated Devices

## Switch Rated Plugs & Receptacles

Meltric's DECONTACTOR™ Series products are UL & CSA listed as switch rated plugs and receptacles. These ratings allow them to be used as a motor circuit disconnect switch, as well as a branch circuit disconnect switch. Switch rated plugs and receptacles have passed electrical overload, short circuit and endurance tests that are far more rigorous than those applied to other plugs and receptacles. These tests include the functional requirements for safety disconnect switches in addition to manual motor controllers. For more information about the tested electrical performance of switch rated devices consult pages 184 - 186.

## Current Interrupting Rated Plugs & Receptacles

Other Meltric devices such as the DXN plugs and receptacles are UL and CSA rated for “current interrupting”. A current interrupting rated plug and receptacle is not subjected to the same level of endurance testing as a switch rated device and does not need to be subjected to any overload-locked rotor or short circuit testing (see pages 184 - 186 for performance test comparisons). Plug and receptacles rated for “current interrupting” are not intended to be used as switches, but can withstand making and breaking of normal resistive loads. Devices that are not hp and short circuit rated are not intended to make and break motor loads or other inductive loads.

## Non-Current Interrupting Rated Plugs & Receptacles

Many competitive plugs and receptacles, as well as some Meltric devices are “non-current interrupting” rated. They are not approved by UL or CSA for connecting or disconnecting under load. They have passed the minimum test requirements for plugs and receptacles but they have not passed current interrupting performance tests or the more demanding electrical endurance, overload and short circuit tests required of switch rated devices. For more information about the tested electrical performance of non-current interrupting rated devices consult pages 184 - 186.



Ratings	Product
Switch Rated	DSN
	DS
	DB
Current Interrupting Rated	DXN
	Multipin
	DR
	PN
	DX, Competitors Pin and Sleeve
Non-Current Interrupting Rated	Multipin
	PF/PFQ
	Competitors Pin and Sleeve

# Electrical Performance

## Overload Conditions

UL & CSA standards for plugs and receptacles require that the devices be able to withstand overload conditions. General use conditions are simulated by testing a device to a specified number of operations (50) at 150% of rated current and a power factor between 0.75 and 0.80. Switch rated plugs and receptacles that are horsepower rated must perform overload testing at 600% of full load motor current with a more severe power factor (between 0.40 and 0.50) to simulate locked rotor conditions.

### UL & CSA Standards – Overload Test Requirements and Ratings Comparisons

Test	UL 1682 & CSA 22.2 No. 182.1		UL Subject 2682 (used for both UL & CSA listings)
	Plugs, Receptacles & Cable Connectors of the Pin & Sleeve Type		Switch Rated Plugs & Receptacles
	Non-Current Interrupting (Typical)	Current Interrupting (Typical)	Motor / Branch Circuit Switch Rated (Typical)
Overload (General Use Devices)	3 Operations @ 150% of Rated Current (p.f. = .75 - .80)	50 Operations @ 150% of Rated Current (p.f. = .75 - .80)	50 Operations @ 150% of Rated Current (p.f. = .75 - .80)
Overload - Locked Rotor (Horsepower Rated Devices)	-	-	50 Operations @ 600% of Full Load Motor Current (p.f. = .40 - .50)

### Test Results: Completed Operations at Overload/Locked Rotor Condition

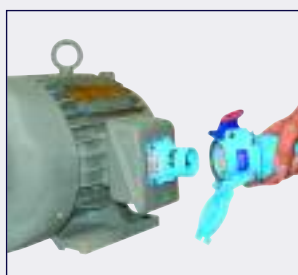
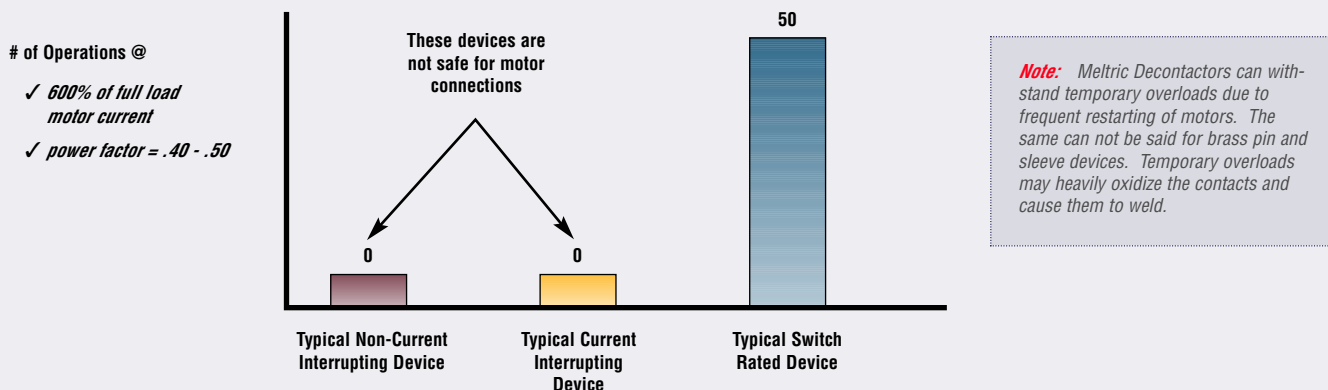

Motors and other equipment can be quickly and safely connected or disconnected with Meltric's Switch Rated DECONTACTOR™ Series plug and receptacles.



# Electrical Performance

## Mechanical and Electrical Endurance

UL and CSA standards require endurance testing to ensure that rated performance is maintained over the expected life of the device. The severity of this testing depends on the rating of the device.

As shown in the chart below, non-current interrupting devices are tested only for mechanical endurance. Current interrupting devices are additionally subjected to moderate electrical endurance testing, and switch rated devices are subjected to a much more severe level of electrical endurance testing, which is similar to that required of disconnect switches. In this regard, switch rated devices may be required to make and break under full load more than 20 times as many operations (depending upon device amperage) as a current interrupting rated pin and sleeve device.

### UL & CSA Standards – Endurance Test Requirements and Ratings Comparisons

Test	UL 1682 & CSA 22.2 No. 182.1		UL Subject 2682 (used for both UL & CSA listings)
	Plugs, Receptacles & Cable Connectors of the Pin & Sleeve Type		Switch Rated Plugs & Receptacles
	Non-Current Interrupting	Current Interrupting	Motor / Branch Circuit Switch Rated
Mechanical Endurance (no load)	15-20A = 5000 Operations 21-63A = 2000 Operations 64-250A = 250 Operations	15-20A = 0 Operations 21-63A = 1000 Operations 64-250A = 500 Operations	6000 Operations (Covered by Electrical Endurance testing)
Electrical Endurance (With Load)	-	15-20A = 5000 Operations 21-63A = 1000 Operations <sup>1</sup> 64-250A = 250 Operations <sup>1</sup> @ Rated Current & Voltage (p.f. = .75 - .80)	6000 Operations @ Rated Current & Voltage (p.f. = .75 - .80)

**Notes:** <sup>1</sup> Testing alternates between mechanical & electrical operations. This reduces the severity of the electrical test by allowing additional cooling time during electrical testing.

### Electrical Endurance Test Comparison

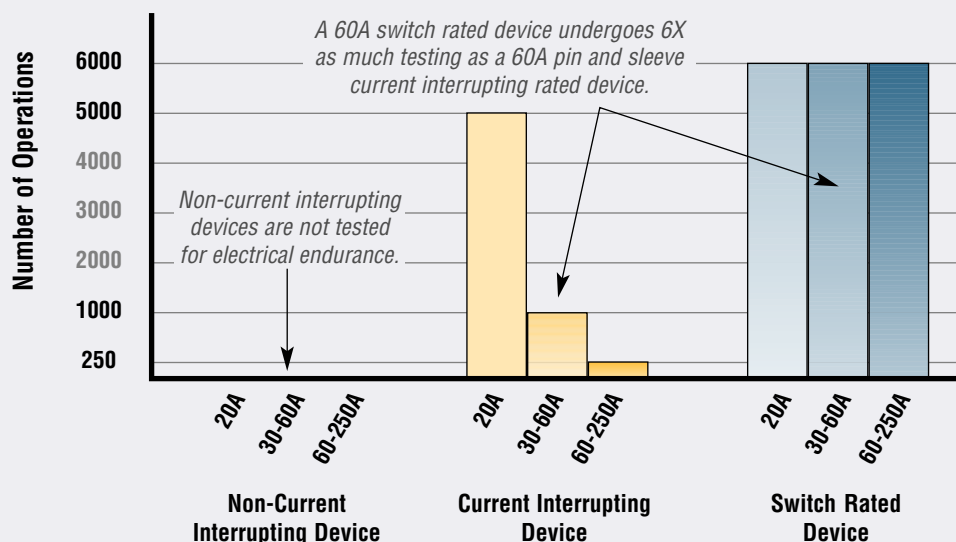

# Electrical Performance

## Short Circuit Protection

Meltric's Decontactors (DS, DSN, and DB products) have successfully completed high fault current short circuit testing. All these devices have short circuit make (close) and withstand ratings of either 65 kA or 100 kA. UL witnessed and approved this testing.

### UL Recognized Short Circuit Capabilities

UL Recognized Short Circuit Capabilities			
Plug & Receptacle Type	Short Circuit Ratings Product		Standard
	Withstand	Make	
General Use Pin & Sleeve Devices	None	None	UL 1682
HP Rated Twist-Type Devices	1kA	None	UL 498
Motor Rated Pin & Sleeve Devices	10kA	None	UL 1682
<b>Meltric Decontactors</b>	<b>≥ 65kA</b>	<b>≥ 65kA</b>	<b>UL Subject 2682</b>

### Short Circuit Test Information

#### Fusing

The amperage and time delay characteristics of the fusing used in testing affects the electrical load seen by the device. UL Subject 2682 requires short circuit tests be performed with fuses having an amperage rating that is no less than 400% of full load motor ampacity for horsepower rated devices, or no less than 100% of the device's amperage rating for general use devices.

Meltric used RK1 non-time delay type fusing for the horsepower rated devices because it is a common type of fuse used in motor applications. Meltric selected RK5 Time Delay fusing for the non-horsepower rated devices (DS9 & DS2) because it represents the most severe case of the various fusing scenarios that are typically used for general use applications.

#### Power Factor

The lower the power factor (p.f.) the more rigorous the test. UL Subject 2682 requires short circuit testing at 42,000 amps and above to be performed with a p.f. of 0.15 or less. By comparison, the p.f. for the 10,000 amp short circuit withstand test required by UL 1682 for horsepower rated plugs & receptacles, is a much less rigorous 0.50.

### Short Circuit Test Summary Table

Device Information			Short Circuit Make & Withstand Rating <sup>1</sup>			
Model	General Use Rating	Max Motor FLA <sup>1</sup>	kA	VAC	Fusing used in Testing	
DSN20	20A	8A (2 hp @ 208 VAC)	100	480	RK1	35A
DSN30	30A	18A (15 hp @ 600 VAC)	100	600	RK1	125A
DSN60	60A	27A (20 hp @ 480 VAC)	100	600	RK1	110A
DS20	20A	11A (3 hp @ 208 VAC)	100	600	RK1	80A
DS30	30A	14A (10 hp @ 480 VAC)	100	600	RK1	125A
DS60	60A	27A (25 hp @ 600 VAC)	100	600	RK1	250A
DS100C	100A	27A (25 hp @ 600 VAC)	100	600	RK1	250A
DS100	100A	-	65	600	RK5 TD	100A
DS200	200A	-	65	600	RK5 TD	200A
DB30	30A	26A (7.5 hp @ 208 VAC)	100	600	RK1	125A
DB60	60A	49A (15 hp @ 208 VAC)	100	600	RK1	250A
DB100	100A	92A (30 hp @ 208 VAC)	100*	600	RK1	250A*

<sup>1</sup> The maximum associated with any of the devices horsepower ratings. The fusing used in the short circuit testing must be at least 400% of this value in order for the short circuit rating to apply to the hp rating.

\* The fusing used limits the 100kA rating to 60hp @ 600V, 40hp @ 480V, 20hp @ 240V & 208V

# Technical Manual

## Contact Technology

Meltric products feature silver-nickel, spring-loaded butt contacts similar to those used in motor starters and contactors.

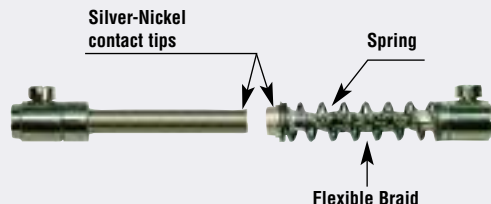

### Silver-Nickel Contact Material

Meltric uses solid silver-nickel (85%/15%) contacts. The silver-nickel material has significant advantages over the brass contacts commonly used on competitive devices.

Silver has very low initial contact resistance and is not negatively affected by oxidation. This helps to give it excellent electrical properties that are maintained even at high temperatures and after tarnishing. Nickel is a much harder material and contributes excellent mechanical properties. The combination of silver and nickel results in a contact material that has both superior electrical capabilities and excellent resistance to wear. Silver-nickel only welds at extremely high pressure and temperature, and thus, also withstands arcs very well. These features make silver-nickel a commonly used contact material by switchgear manufacturers.

By contrast, the brass material used in most competitive plugs and receptacles has much higher initial contact resistance and is negatively affected by oxidation. In an oxidized state, the contact resistance of brass is more than 20 times higher than that of silver-nickel. In addition, brass is a soft material that wears rapidly. In use, brass pin and sleeve and arcuate contacts suffer from the combined effects of the limitations of the material and the design. As oxidation and wear induced reductions in contact force occur, contact resistance increases. This increases operating temperature, which causes further oxidation and wear, perpetuating a vicious cycle of degradation. Brass is not arc resistant and is not suitable for making and breaking under load.

MATERIAL	CONTACT RESISTANCE	
	New	Oxidized
SILVER	6 $\mu\Omega$	25 $\mu\Omega$
SILVER-NICKEL	23 $\mu\Omega$	60 $\mu\Omega$
COPPER	29 $\mu\Omega$	400 $\mu\Omega$
BRASS	370 $\mu\Omega$	1400 $\mu\Omega$

*In an oxidized state, silver-nickel is 20 times more conductive than brass.*

### Spring-Loaded Contacts

Spring-loading of the contacts ensures that optimal pressure between the contacts is maintained – even after tens of thousands of operations. This point is important because contact force is a key determinant of the quality of the connection. As the accompanying graph demonstrates, contact resistance increases as contact force decreases. Higher contact resistance generates more heat and oxidation, both of which contribute to the deterioration of the contact. This is a problem with pin and sleeve and arcuate type contacts because their contact force varies with manufacturing tolerances and is reduced due to wear that occurs with normal use.

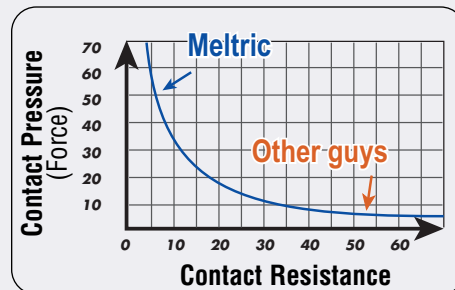

*Higher contact pressure leads to lower contact resistance.*

### Butt-Style Connection

Meltric's butt-style contact configuration provides a positive and secure connection and also makes connection and disconnection easy. With butt contacts, the force applied to the contacts is in-line with the insertion motion, so inserting a plug into it's socket requires only a known and limited amount of effort. Contact wear and sensitivity to manufacturing tolerances is negligible, because the spring-loading is sufficient to compensate for minor differences in contact length.

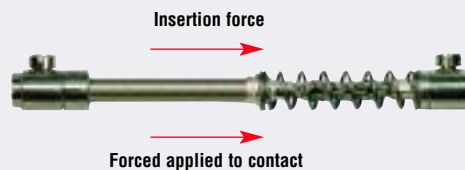

*With Meltric's butt contacts the force applied to the contacts is in-line with the insertion motion.*

With the pin and sleeve design used by our competitors, the contact force is at a right angle to the insertion/withdrawal force. There are numerous drawbacks to such a design:

- ▼ The contact pressure must be sufficient to prevent excessive temperature rise but is limited by the need to keep the insertion force reasonable.
- ▼ The necessary friction wears out the contacts, and diminishes contact pressure over time.
- ▼ Normal manufacturing tolerances result in wide variations in performance, even with new devices.
- ▼ The sliding contact design does not make & break cleanly, so arcing is more likely to occur.

### Quick Break Mechanism

On most Meltric devices, the circuit is broken simply by depressing the pawl. Doing so releases the energy in a spring-loaded operating mechanism, which instantaneously breaks the circuit and ejects the plug to the 'OFF' position. Contact breaking time is about 15 milliseconds. The quick break mechanism is automatically reloaded when the plug is re-inserted.

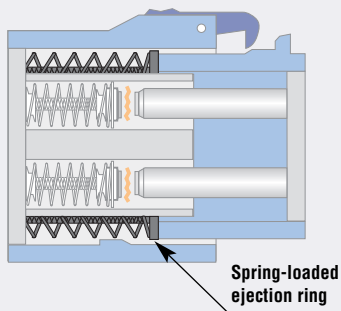

*Spring-loaded ejection system ensures a quick break of the contacts.*

In contrast, the disconnection speed of pin and sleeve and twist type devices is dependent on the users motion when removing the plug.

### Self Cleaning System

Meltric contacts close with a self-cleaning, wiping action. When the contacts initially mate, they are slightly offset. In completing the connection, the plug contacts are rotated partially across the receptacle contacts, helping to remove deposits from the contact surface.

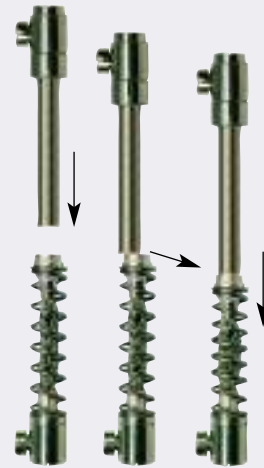

*Meltric contacts are self cleaning.*

### Contact Mating Sequence

Decontactor contacts mate in a specific sequence to ensure a proper and safe connection.

1. The earth (ground) closes first
2. Then the neutral,
3. Then the phases,
4. Then the auxiliary contacts, if any. These auxiliary contacts can, therefore, be used as "pilot" contacts.

On opening, the sequence is reversed.

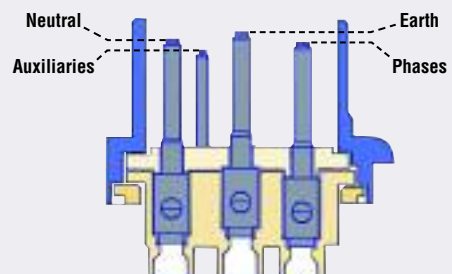

*The contacts are set in the plug at different levels to achieve the desired mating sequence.*

# Technical Manual

## Dead Front and Enclosed Arc Chambers For Maximum Protection from Live Parts

Most Meltric receptacles feature a dead front which encloses and isolates the live contacts when the plug is removed. Only electrically compatible plugs can unlock the safety shutter and gain access to the live parts. In addition to preventing accidental exposure to live parts, the safety shutter also keeps the contacts clean and out of reach even if the lid is left open.



The receptacle's dead front protects workers from accidental tool and wire insertion.

### Protection During the Making and Breaking Process

When disconnecting or connecting a Meltric plug from/to a receptacle, the user is completely protected from exposure to arc flash or live parts. This is because the contacts can only make or break while they are enclosed in internal arc chambers within the receptacle.

During disconnection, the pressing of the pawl on the receptacle breaks the connection (inside the arc chambers) and ejects the plug to its rest or "OFF" position. While in the rest position, the plug and receptacle casings maintain a dead front and thus protect the user from live parts. The plug can not be fully withdrawn until it is rotated 30° counterclockwise. This closes and locks the safety shutter preventing access to live parts during and after the removal of the plug.

During connection, the plug contacts can only access the receptacle contacts after the plug has been partially inserted into the receptacle and has then been rotated 30° to open the safety shutter. Because the interaction of the skirted plug casing with the receptacle forms a protective enclosure that prevents access to the contacts as soon as insertion begins, a dead front is maintained even after the safety shutter is opened. Once the safety shutter has been opened, the plug contacts can be safely inserted into the arc chambers where the connection is made as the plug is latched to the receptacle.

### Protection from Insertion of Inappropriate Plugs

Meltric products offer up to 24 different keying positions. Only plugs and receptacles that are keyed/notched in the same positions will mate with each other. Non-compatible plugs will be unable to open the safety shutter. This system prevents potentially dangerous situations. For example, a 250V plug (notch 16) can not be inserted into a 480V receptacle (notch 04). Alternatively, on the PF and DX series, pegs and holes perform the same function as the notches.

**Note:** Some of the keying positions have been assigned to a designated global voltage. A few others are unassigned and are available if a user prefers to limit mating of plugs and receptacles that are only to be used on particular applications.

**Note:** *Coding Disk* Some receptacles utilize a coding disk which performs the same functions as does the one piece safety shutter.

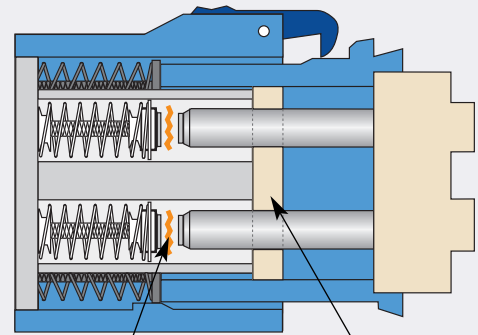

Arc chamber prevents outside exposure to arc flash.

Safety shutter prevents finger or tool access to live parts.

## Commonly Used Keying Positions

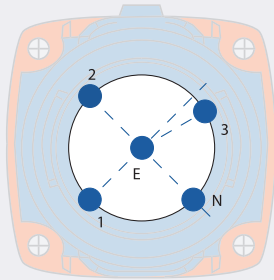

**Position 04**  
255-277V/440-480V 60Hz

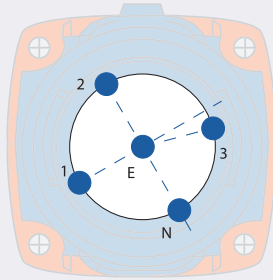

**Position 07**  
110-125/220-250V 50Hz

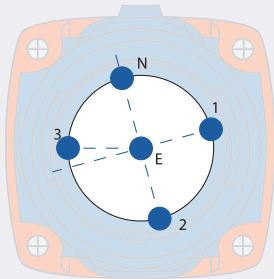

**Position 14**  
347/600V 60Hz

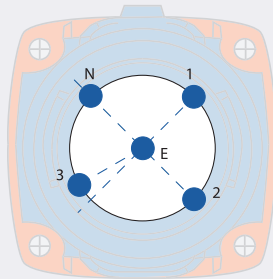

**Position 16**  
120-127V/208-220V 60Hz

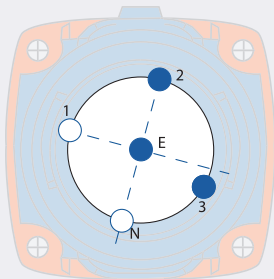

**Position 02**  
20-24V DC

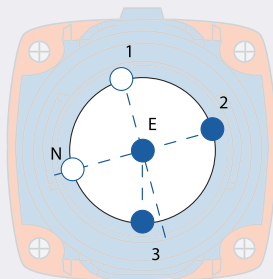

**Position 20**  
220-250V DC

*Note:* See chart on page 13 for a complete list of voltage polarization positions and associated voltages.

## How to Identify Keying Positions of an Existing Device

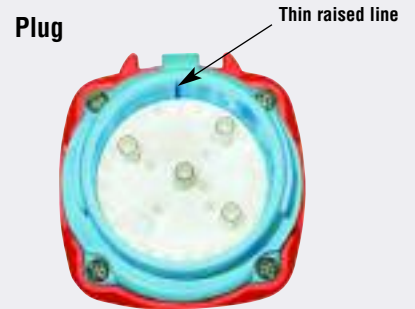

The keying position of most Meltric plugs can be determined by looking at the plug interior and finding a thin, raised line in the casing. This line is always directly above a number that identifies the plug's keying position.

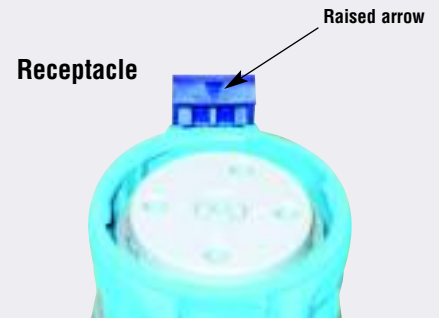

The keying position for most receptacles can be determined by identifying a raised arrowhead (usually on the pawl or on the casing next to the pawl). This arrow points to a key number that can be found on the ring that surrounds the safety shutter.

## Dual Voltage Devices Maximize User Flexibility

Some Meltric receptacles are designed to safely allow dual voltage capabilities.

For example, a 208V rated 3P+N+E receptacle will safely provide power to several configurations of 208V plugs and a single phase 120V plug. Having two voltages delivered by a single receptacle allows some facilities to significantly reduce the number of receptacles that need to be installed.

Dual voltage receptacles are supplied with dual color coded voltage stickers.

## Dual Voltages Typically Available from Meltric

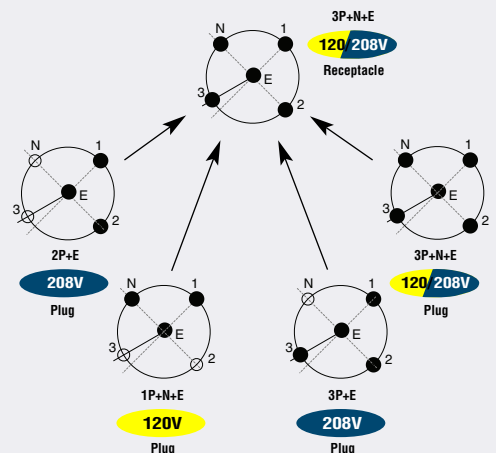
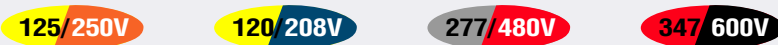

# Device Materials and their Resistance to Environments and Chemicals

## Polymeric Materials

**Casings** – The common technical name for the “Poly” material used by Meltric is PBT or PBTP (Poly Buthylene Tere Phthalate). It consists of a special blend of thermoplastic polyester, fiberglass and elastomers which provides outstanding resistance to most chemical agents and environmental conditions, including UV and gamma rays. This material also offers high impact resistance across a broad spectrum of temperatures (shock resistance ratings to IK08).

**Interiors** – The arc chambers for most Meltric devices are made of Melamine or of a special compound of thermoplastic polyester, fiberglass, and elastomer. Other materials are used such as Polyamide and Bakelite.

**Accessories** – Handles, angles and wall boxes are made of Polyamide (they are supplied with self tapping screws).

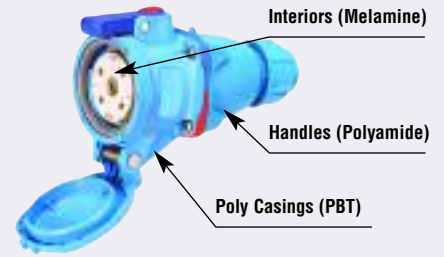

### Products with Poly (PBT) casings

DSN20, DSN30, DSN60

DS20, DS30, DS60, DS100, DS100C

DR30, DR50, DR100, DR150

DXN20, DXN30, DXN60

DSN24, DSN37, DS7, DR7

## Resistance of Polymeric Casings to Various Chemical Agents

Agent	Polyester reinforced glass fiber			Polyamide		
	23°C	60°C	80°C	23°C	60°C	80°C
Butyl acetate	☆☆	☆☆		☆☆		
Ethyl acetate	☆			☆☆		
Acetone	☆			☆☆		
Acetic acid	5%	☆☆	☆☆	☆	☆	-
	10%	☆☆	☆	☆	-	-
Hydrochloric acid	10%	☆☆	☆☆	☆☆	☆	-
Chromic acid	40%	☆☆	☆☆	☆☆	-	-
Citric acid	10%	☆☆	☆☆	☆☆	☆	
Formic acid	5%	☆☆	☆	☆☆	☆	
Nitric acid	10%	☆☆	☆	☆☆	☆	-
Oleic acid	100%	☆☆	☆☆	☆☆	☆☆	☆☆
Phosphoric acid	3%	☆☆	☆☆	☆☆	☆☆	☆☆
	30%	☆☆	☆☆	☆☆	☆☆	☆☆
	85% (conc)	☆☆	☆☆	☆☆	-	-
Sulphuric acid	3%	☆☆	☆☆	☆☆	-	-
	30%	☆☆	☆☆	☆☆	-	-
Ethyl alcohol		☆☆		☆☆		
Methyl alcohol		☆☆		☆☆		
Aniline		☆☆		-		
Benzene		☆	☆	☆☆		
Soda Bicarbonate	10%	☆☆	☆	-	☆☆	☆☆
Potassium bichromate	10%	☆☆			☆☆	☆☆
Sodium bisulphate	10%	☆☆	☆	-	☆☆	☆☆
Butane		☆☆		☆☆		
Butanol		☆	☆	☆☆		
Soda carbonate	10%	☆☆	-	-	☆☆	☆☆
	20%	☆☆	-	-	☆☆	☆☆
Disulphuric carbonate		☆☆		☆☆		
Calcium chloride	10%	☆☆	☆☆		☆☆	
Potassium chloride	10%	☆☆	☆	-	☆☆	
Sodium chloride	10%	☆☆	☆	-	☆☆	
Detergents	1%	☆☆	☆	-	☆☆	☆☆
	25%	☆☆	☆	-	☆☆	☆☆
Dibutylphthalate		☆☆	☆☆		☆☆	
Dichlorethane		-		☆☆		
Dioxane		☆☆	-	☆☆		
Water		☆☆	☆☆	-	☆☆	☆☆
Bleach		☆☆	☆☆		☆☆	☆☆
Gas		☆☆		☆☆		
Turpentine		☆☆		☆☆		

Agent	Polyester reinforced glass fiber			Polyamide		
	23°C	60°C	80°C	23°C	60°C	80°C
White spirit	☆☆			☆☆		
Ether	☆☆			☆☆		
Freon 11	☆☆			☆☆		
Glycerine	☆	☆		☆☆	☆	-
Glycol	☆	☆		☆☆	☆	-
Grease	☆☆	☆☆	☆☆	☆☆	☆☆	☆☆
Heptane	☆☆			☆☆		
Hexane	☆☆			☆☆		
Cotton seed oil	☆☆	☆☆	☆☆	☆☆	☆☆	☆☆
Silicon oil	☆☆	☆☆	☆☆	☆☆	☆☆	☆☆
Processing oil	☆☆	☆☆	☆☆	☆☆	☆☆	☆☆
Diesel oil	☆☆			☆☆		
Olive oil	☆☆	☆☆	☆☆	☆☆	☆☆	☆☆
Mineral oil	☆☆	☆☆	☆☆	☆☆	☆☆	☆☆
Engine oil	☆☆	☆☆	☆☆	☆☆	☆☆	☆☆
Plant oil	☆☆	☆☆	☆☆	☆☆	☆☆	☆☆
Ammonium hydroxide	10%	☆		☆☆		
	conc	-		☆☆		
Potassium hydroxide	1%	-	-	☆☆		
	10%	-	-	☆☆		
Sodium hydroxide	1%	-	-	☆☆		
	10%	-	-	☆☆		
Calcium hypochlorite		☆☆	☆☆	☆☆		
Sodium hypochlorite	10%	☆☆	☆	-	-	-
Isopropanol		☆	☆	☆☆		
Braking liquid		☆☆	☆☆	☆☆	☆☆	
Methylethycetone		☆☆	☆☆	☆☆	☆☆	
Perchloroethylene		☆☆	☆☆	☆☆	☆☆	☆☆
Potassium permanganate	10%	☆☆				
Oil		-		-		
Hydrogen peroxide	3%	☆☆		-		
	30%	☆☆		-		
Soap solution	1%	☆☆	-	-	☆☆	
Carbon tetrachloride		☆☆		☆☆		
Tetrahydrofurane		☆		☆☆		
Toluene		☆☆		☆☆		
Trichlorethylene		☆☆		☆☆	☆☆	☆☆
Vaseline		☆☆	☆☆	☆☆	☆☆	☆☆
Xylene		☆☆		☆☆		

Legend: ☆☆☆ = Excellent ☆ = Good - = Poor

## Metal Materials

**Casings** – Metal casings providing even greater impact resistance are standard on some Meltric products and are optional on others. Depending upon the product line, these casings may be made of zamak, aluminum or stainless steel. Zamak, a zinc - aluminum alloy is the most commonly used. Zamak receptacles are blue epoxy coated and zamak plugs are specially treated to further improve corrosion resistance.

**Contacts** – All Meltric contact surfaces are made of solid silver-nickel with the exception of the PF and PFQ contacts which are solid pure silver. Silver-nickel and silver both provide excellent resistance to climatic conditions and to all known chemical agents found in industry with the exception of sulphuric acid. Products installed in sulphuric acid environments should have an environmental rating of at least NEMA 4X or IP 66.

**Accessories** – Wall boxes, angles, and handles are in zamak or aluminum alloy. All zamak accessories are standardly protected by an epoxy paint.

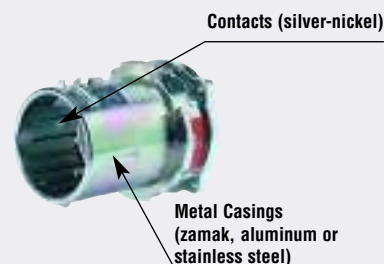

### Products with Metal Zamak casings:

DS60, DS100C, DS100, DS200

DB30, DB60, DB100

DR100, DR150, DR250

PN7, PN12, DN7, DN20, DS7, DR7

### Products with Aluminum Casings

PN (HT)

DX20, DX30, DX60, DX100

PFQ300, PF300, PF400, PF600

### Products with Stainless Steel Casings

PN12

DS24, DS37

*Contact customer service for availability of Stainless Steel on other products*

## Resistance of Metal Casings to Corrosive Agents

Agent	Protected Zamak or Aluminum
Dry lighting gas	☆☆
Water steam	☆
Hot water	☆
Artificial sea water	☆
Soluble oil 3%	☆
Soluble oil 5%	☆☆
Cleansing soap	☆☆
Potash solution 1%	☆
Potash solution 5%	☆
Ammonia 1%	☆
Ammonia 5%	☆
Sodium chloride 1%	☆
Sodium chloride 5%	☆
Acetic acid 1%	☆
Acetic acid 5%	–
Gas	☆☆
Engine oil	☆☆
Printing ink	☆
Ethyl or methyl alcohol	☆☆
Trichloethylene	☆
Dry insecticides	☆

Legend: ☆☆ = Excellent ☆ = Good – = Poor



# Technical Manual

## Watertightness / Ingress Protection (NEMA and IP ratings)

### Environmental Ratings for Meltric Devices



Most Meltric products achieve rated watertightness as soon as the plug is fully inserted into the receptacle. The primary exception is the DB product line which requires the turning of a locking ring.

Product	NEMA	IP (plug + receptacle)	IP (receptacle alone)
DSN	4X	66+67	66+67
DS+	3R	54	55
DB	-	67	67
DXN	4X	66+67	66+67
DX	-	65	65
DN	-	54	55
PF/PFQ	-	66+67	66+67
DR+	3R	54	55
PN	4X	66+67	66+67
SP	-	66+67	66+67

\* Additional watertightness is available on DS and DR devices, see pg 174

### Environmental Ratings Explained:

#### NEMA/UL/CSA Enclosure Types (UL50)

NEMA Enclosure Type	Intended Use and Description
1	Indoor use primarily to provide a degree of protection against limited amounts of falling dirt
2	Indoor use primarily to provide a degree of protection against limited amounts of waste and falling dirt
3, 3R, 3S	Outdoor use primarily to provide a degree of protection against rain, sleet, and damage from external ice formation.
4, 4X	Indoor or outdoor use primarily to provide a degree of protection against windblown dust and rain, splashing water, hose-directed water, and damage from external ice formation
12	Indoor use primarily to provide a degree of protection against circulating dust, falling dirt and dripping non-corrosive liquids

#### IP Ratings (IEC/EN 60529)

First Digit		Second Digit	
Protection against the ingress of solid foreign objects and access to hazardous parts		Protection against the ingress of water with harmful effects	
0	No protection	0	No protection
1	50mm Back of hand	1	Vertically dripping water (condensation)
2	12.5mm Finger	2	Dripping water at 15°
3	2.5mm Tool	3	Spraying water at 60° (rain)
4	1mm Wire	4	Splashing water from any direction
5	Against Dust -	5	Jetting water from any direction
6	Dust-tight -	6	Powerful jetting water from any direction
-		7	Temporary submersion

# Impact Resistance

Meltric product resistance to mechanical shocks is specified in accordance with their IK ratings.

## Meltric Products IK Ratings (per IEC/EN 50102)

Product	Material	IK Rating
DSN	Poly	08 (5 Joules)
DS	Poly	08 (5 Joules)
DS	Metal	09 (10 Joules)
DB	Metal	09 (10 Joules)
DR	Poly	08 (5 Joules)
DR	Metal	09 (10 Joules)
DN	Metal	09 (10 Joules)
PN	Poly	08 (5 Joules)
PN	Metal	09 (10 Joules)
PF	Metal	10 (20 Joules)
DX	Metal	10 (20 Joules)
DXN	Poly	08 (5 Joules)



# Operating Temperatures

All Meltric plugs and receptacles can be used with no particular precaution from -15°F to 140°F/-26°C to 60°C.

## Hot Temperatures

Some devices that do not contain any polyamide can operate up to 175°F/80°C but precise conditions and duty cycles must be submitted to the Meltric engineering department for approval. A limited range of products are available for ambient temperatures up to 365°F/185°C. Contact Meltric customer service for more information.

## Cold Temperatures

Below -15°F materials become more brittle and impact should be avoided, especially on polyamide materials. However, Meltric's metal and polyester casings can be used as low as -40°F/-40°C and some Meltric devices are in service at -75°F/-60°C. Consult factory for more information.

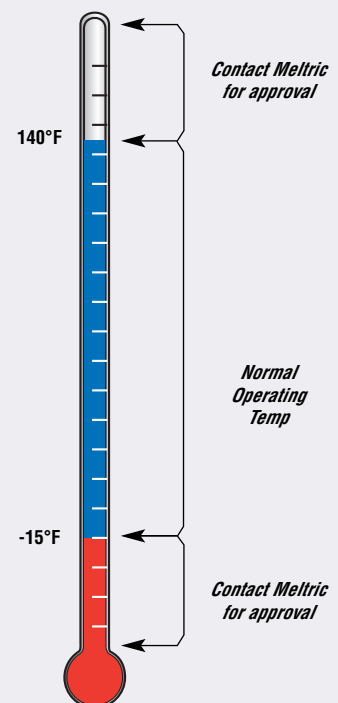

# Color Coded Gaskets & Labels For Voltage Identification

PIN CONFIGURATION	VOLTAGE	FREQUENCY	5 <sup>th</sup> , 6 <sup>th</sup> and 7 <sup>th</sup> PART NUMBER DIGITS	RECEPTACLE/CONNECTOR		PLUG/INLET	
				COLOR GASKET	VOLTAGE STICKER	COLOR GASKET	VOLTAGE STICKER
1P+N+E	110/130V	50Hz	035	YELLOW	YELLOW	YELLOW	YELLOW
	115/127V	200Hz	125	GREEN	YELLOW	GREEN	YELLOW
	115/127V	400Hz	115	GREEN	YELLOW	GREEN	YELLOW
	120/127V	60Hz	165	YELLOW	YELLOW	YELLOW	YELLOW
	110/125V	60Hz	075	ORANGE	ORANGE	ORANGE	ORANGE
	220/250V	50Hz	015	BLUE	BLUE	BLUE	BLUE
	255/277V	60Hz	045	GREY	GREY	GREY	GREY
	347V	60Hz	145	RED	RED	RED	RED
	380/440V	50Hz	195	RED	RED	RED	RED
	577V	50Hz	225	BLACK	BLACK	BLACK	BLACK
2P	20/24V	50Hz	08A	VIOLET	VIOLET	VIOLET	VIOLET
	20/24V	60Hz	02A	VIOLET	VIOLET	VIOLET	VIOLET
	20/24V	DC	08Z	VIOLET	VIOLET	VIOLET	VIOLET
	25/28V	50Hz	06A	SKY BLUE	SKY BLUE	SKY BLUE	SKY BLUE
	25/28V	DC	06Z	SKY BLUE	SKY BLUE	SKY BLUE	SKY BLUE
	40/48V	DC	13Z	WHITE	WHITE	WHITE	WHITE
	40/48V	50Hz	13A	WHITE	WHITE	WHITE	WHITE
2P+E	110/130V	DC	109	YELLOW	YELLOW	YELLOW	YELLOW
	200/220V	200Hz	122	GREEN	BLUE	GREEN	BLUE
	200/220V	400Hz	112	GREEN	BLUE	GREEN	BLUE
	208/220V	60Hz	162	BLUE	BLUE	BLUE	BLUE
	220/250V	50Hz	032	BLUE	BLUE	BLUE	BLUE
	220/250V	DC	209	BLUE	BLUE	BLUE	BLUE
	220/250V	60Hz	072	ORANGE	ORANGE	ORANGE	ORANGE
	380/440V	50Hz	012	RED	RED	RED	RED
	440/480V	60Hz	042	RED	RED	RED	RED
	480/500V	50Hz	092	BLACK	BLACK	BLACK	BLACK
	600V	60Hz	142	BLACK	BLACK	BLACK	BLACK
	660/690V	50Hz	192	BLACK	BLACK	BLACK	BLACK
	1000V	50Hz	222	BLACK	BLACK	BLACK	BLACK

PIN CONFIGURATION	VOLTAGE	FREQUENCY	5 <sup>th</sup> , 6 <sup>th</sup> and 7 <sup>th</sup> PART NUMBER DIGITS	RECEPTACLE/CONNECTOR		PLUG/INLET	
				COLOR GASKET	VOLTAGE STICKER	COLOR GASKET	VOLTAGE STICKER
2P+N+E	115 / 127V 200 / 220V	200Hz	126	GREEN	YELLOW BLUE	GREEN	YELLOW BLUE
	115 / 127V 200 / 220V	400Hz	116	GREEN	YELLOW BLUE	GREEN	YELLOW BLUE
	120 / 127V 208 / 220V	60Hz	166	BLUE	YELLOW BLUE	BLUE	YELLOW BLUE
	110 / 130V 190 / 230V	50Hz	036	BLUE	YELLOW BLUE	BLUE	YELLOW BLUE
	110 / 125V 220 / 250V	60Hz	076	ORANGE	ORANGE	ORANGE	ORANGE
	220 / 250V 380 / 440V	50Hz	016	RED	BLUE RED	RED	BLUE RED
	255 / 277V 440 / 480V	60Hz	046	RED	RED	RED	RED
	480/500V	50Hz	096	BLACK	BLACK	BLACK	BLACK
	347/600V	60Hz	146	BLACK	RED BLACK	BLACK	RED BLACK
	380 / 400V 660 / 690V	50Hz	196	BLACK	RED BLACK	BLACK	RED BLACK
3P+E	200/220V	200Hz	123	GREEN	BLUE	GREEN	BLUE
	200/220V	400Hz	113	GREEN	BLUE	GREEN	BLUE
	208/220V	60Hz	163	BLUE	BLUE	BLUE	BLUE
	220/250V	50Hz	033	BLUE	BLUE	BLUE	BLUE
	220/250V	60Hz	073	ORANGE	ORANGE	ORANGE	ORANGE
	380/440V	50Hz	013	RED	RED	RED	RED
	440/480V	60Hz	043	RED	RED	RED	RED
	480/500V	50Hz	093	BLACK	BLACK	BLACK	BLACK
	600V	60Hz	143	BLACK	BLACK	BLACK	BLACK
	660/690V	50Hz	193	BLACK	BLACK	BLACK	BLACK
1000V	50Hz	223	BLACK	BLACK	BLACK	BLACK	
3P+N+E	110 / 130V 220 / 250V	50Hz	037	BLUE	YELLOW BLUE	BLUE	YELLOW BLUE
	115 / 127V 200 / 220V	200Hz	127	GREEN	YELLOW BLUE	GREEN	YELLOW BLUE
	115 / 127V 200 / 220V	400Hz	117	GREEN	YELLOW BLUE	GREEN	YELLOW BLUE
	120 / 127V 208 / 220V	60Hz	167	BLUE	YELLOW BLUE	BLUE	YELLOW BLUE
	110 / 125V 220 / 250V	60Hz	077	ORANGE	ORANGE	ORANGE	ORANGE
	220 / 250V 380 / 440V	50Hz	017	RED	BLUE RED	RED	BLUE RED
	255 / 277V 440 / 480V	60Hz	047	RED	RED	RED	RED
	347/600V	60Hz	147	BLACK	RED BLACK	BLACK	RED BLACK
	380 / 400V 660 / 690V	50Hz	197	BLACK	RED BLACK	BLACK	RED BLACK
	MULTIPIN		NOT SPECIFIED		SKY BLUE	SKY BLUE	SKY BLUE

# Index

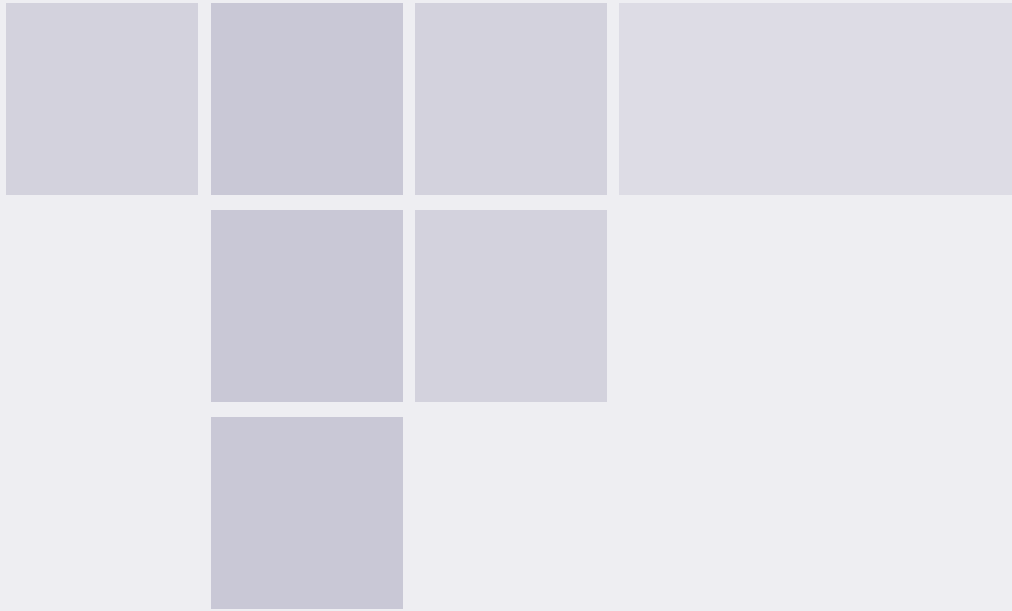



# Index

**Suffix Index**

**p. 199**

**Part Number Index**

**p. 201**

**Literature Order Form**

**p. 212**

# Suffixes

## Quick Reference Table

Suffix	Description	Applicable Products	Special Instructions
-001	Reverse interior for PN, DSN24, DSN37 device only	PN, DSN24, DSN37	Add to inlet and receptacle part numbers
-026	Black device gasket	DS, DR, DSN	
-06B	Suffix for DR inlets & receptacles	DR	Included in inlet & receptacle part number
-080	Junction box with angle	All	
-1	1" NPT thread size for conduit entry	DSN, DS, DR, DX, PN, DN, DB	Add to applicable accessories
-112	1 1/2" NPT thread size for conduit entry	DSN, DS, DR, DX, DN, DB	Add to applicable accessories
-12	1/2" NPT thread size for conduit entry	DS, DR, DX, DN, DB	Add to applicable accessories
-114	1 1/4" NPT thread size for conduit entry	DSN, DS, DR, DX, PN, DN, DXN, DB	Add to applicable accessories
-12N	Suffix for DR inlets & receptacles	DR	Included in inlet & receptacle part number
-142	Recess plate for receptacle	DS3, DS6, DR50, DR100, DS100C, PN	
-17B	Suffix for DR inlets & receptacles	DR	Included in inlet & receptacle part number
-172	Two auxiliary pilot contacts	DS2, DS9, DB3, DB6	Add to inlet or receptacle part number
-173	Three auxiliary pilot contacts	DS2, DS9	Add to inlet or receptacle part number
-174	Four auxiliary pilot contacts	DS2, DS9, DB9	Add to inlet or receptacle part number
-175	Five auxiliary pilot contacts	DS2, DS9	Add to inlet or receptacle part number
-180	180° lid opening for flush mounted inlets	DS, DR, DXN	Add to the receptacle part number
-185	High temp product	PN	Add to inlet or receptacle part number
-2	2" NPT thread size for conduit entry	DS, DR, DX, DN, DB	Add to applicable accessories
-200	Cable range for PF/PFQ Handle 2.000" - 2.125"	PF/PFQ	Add to the handle part number
-20	2" NPT fitting size	PF/PFQ	Add to PF/PFQ junction box
-20P	Cable range .28" - .41"	DXN1, DXN3	Add to plug/connector part number
-212	2 1/2" NPT thread size for conduit entry	DS, DR, DN	
-21R	Suffix for DR inlets & receptacles	DR	Included in inlet & receptacle part number
-225	Cable range for PF/PFQ Handle 2.125" - 2.375"	PF/PFQ	Add to the handle part number
-226	Spring loaded cap for inlet	DS	Add to the inlet part number
-237	Cable range for PF/PFQ Handle 2.25" - 2.375"	PF/PFQ	Add to the handle part number
-24R	Suffix for DR inlets & receptacles	DR	Included in inlet & receptacle part number
-25	2 1/2" NPT fitting size	PF/PFQ	Add to PF/PFQ junction box
-25P	Cable range .35" - .67"	DXN	Add to plug/connector part number
-250	Cable range for PF/PFQ Handle 2.375" - 2.5"	PF/PFQ	Add to the handle part number
-263	Three auxiliary pilot contacts	DS6, DS100C	
-270	Auxiliary switch for female devices	DS, DSN, DR	Add to receptacle part number
-275	Cable range for PF/PFQ Handle 2.5" - 2.75"	PF/PFQ	Add to the handle part number
-30	3" NPT fitting size	PF/PFQ	Add to PF/PFQ junction box
-300	Cable range for PF/PFQ Handle 2.75" - 3"	PF/PFQ	Add to the handle part number
-30A	30A capacity for PN devices	PN	Add to inlet & receptacle part numbers
-312	Cable range for PF/PFQ Handle 3" - 3.125"	PF/PFQ	Add to the handle part number
-32P	Cable range .43" - .83"	DXN	Add to plug/connector part number

Suffix	Description	Applicable Products	Special Instructions
-335	Cable range for PF/PFQ Handle 3.125" - 3.35"	PF/PFQ	Add to the handle part number
-338	PRL release pawl	DS, DSN, DR	Add to inlet part number
-338-A188	PRL release pawl with straight insertion (for inlets)	DS, DN, DSN, DR	Add to inlet part number
-34	3/4" NPT thread size for conduit entry	DSN, DS, DR, DX, PN, DN, DXN, DB	Add to applicable accessories
-345-A188	SRL release pawl with straight insertion for receptacles	DSN	Add to receptacle part number
-348-A188	SRL release pawl with straight insertion for receptacles	DS, DN, DR	Add to receptacle part number
-35	3 1/2" NPT fitting size	PF/PFQ	Add to PF/PFQ junction box
-350	Cable range for PF/PFQ Handle 3.35" - 3.5"	PF/PFQ	Add to the handle part number
-375	Emergency stop pawl	DS, DSN, DXN, DR	Add to receptacle part number
-3NF	Non functioning contact to activate auxiliary switch	DS, DSN	Activates 2 Pole 4 wire receptacle.
-40	4 1/2" NPT fitting size	PF/PFQ	Add to PF/PFQ junction box
-40P	Cable range .75" - 1.10"	DXN	Add to plug/connector part number
-473	Finger drawplate on handle	DS	Add to handle part number
-48	Inlet without cap	PF, DB	Add to the inlet part number
-601	Special adapter plate for DSN1 angle on junction box	DSN1	
-824	Metal pawl for poly receptacles	DS, DR	
-824-300	Locking pawls	PN	Add to the receptacle part number
-843	Padlock pawl	DS, DSN	Add to receptacle part number
-845	Oversize padlock pawl	DS	Add to receptacle part number
-972	Two auxiliary pilot contacts	DS1, DS3, DS6, DSN3, DSN6	Add to inlet or receptacle part number
-973	Three auxiliary pilot contacts	DS3, DS6, DSN6	Add to inlet or receptacle part number
-974	Four auxiliary pilot contacts	DS3, DS6, DSN6	Add to inlet or receptacle part number
-A06	Allows up to 4/0 AWG wiring capacity	DS2	Add to inlet part number
-A09	Suffix designating 225A capacity on appropriate DR device	DR225	Included in inlet & receptacle part number
-A155	Inlet without the standard lockout hole	DS, DSN	Add to inlet part number
-A188	Straight insertion	DS, DSN, DN, DR	Add to inlet and receptacle part number
-B	Bottom interior piece	All	
-CG	Cable guide for PRL or SRL release pawl for handle	DS, DSN, DN	Add to handle part number
-C-***	Suffixes for DS100C inlets & receptacles	DS	Included in inlet & receptacle part number
-E323	Allows up to 2/0 AWG wiring capacity	DS9, DR150	
-HP	High pressure water protection.	DS, DR, PN	Add to inlet and receptacle
-LP	Low pressure water protection.	DS, DR	Add to inlet and receptacle
-NC	Normally closed lid	DS, DSN, DR, DN	Add to receptacle part number
-NNF	Non Functioning Neutral - Activates 3 Pole 4 wire receptacle	DS, DSN, DR	
-NP	No paint on accessories	All accessories	
-R	Normally closed lid	DXN	Add to receptacle part number
-SS	Stainless steel	PN7, PN12, DS	
-T	Top interior piece	All	



# Parts Index

Part Number	Pages	Part Number	Pages	Part Number	Pages	Part Number	Pages	Part Number	Pages
01-2A010	151	01-N4075	147	01-S4072	147	09-24012-185	149	09-M4071	91
01-2A010-185	151	01-N4076	147	01-S4073	147	09-24013-185	149	09-M4080	91
01-2A010-185-B	151	01-N4142	147	01-S4075	147	09-24015-185	149	09-M4081	91
01-2A010-185-T	151	01-N4143	147	01-S4076	147	09-24016-185	149	09-M4090	91
01-2A010-B	151	01-N4151	147	01-S4142	147	09-24017-185	149	09-M4091	91
01-2A010-T	151	01-N4162	147	01-S4143	147	09-24032-185	149	09-M4100	91
01-2A011	151	01-N4163	147	01-S4147	147	09-24033-185	149	09-M4101	91
01-2A011-185	151	01-N4167	147	01-S4162	147	09-24035-185	149	09-M4110	91
01-2A020	152	01-N8042	147	01-S4163	147	09-24037-185	149	09-M4111	91
01-2A020-185	152	01-N8043	147	01-S4167	147	09-28012-185	149	09-M4120	91
01-2A020-185-B	152	01-N8045	147	04-2A090-5-10	92*	09-28013-185	149	09-M8051	91
01-2A020-185-T	152	01-N8047	147	04-2A090-5-12	92*	09-28015-185	149	09-M8060	91
01-2A020-B	152	01-N8072	147	04-2A090-5-34	92*	09-28016-185	149	09-M8061	91
01-2A020-T	152	01-N8073	147	09-04041-SS	103	09-28017-185	149	09-M8070	91
01-2A021	152	01-N8075	147	09-04050-SS	103	09-28032-185	149	09-M8071	91
01-2A021-185	152	01-N8076	147	09-04051-SS	103	09-28033-185	149	09-M8080	91
01-2A142	92*	01-N8142	147	09-04060-SS	103	09-28035-185	149	09-M8081	91
01-M4051	91	01-N8143	147	09-04061-SS	103	09-28037-185	149	09-M8090	91
01-M4060	91	01-N8147	147	09-04070-SS	103	09-2A013-SS-12	94	09-M8091	91
01-M4061	91	01-N8162	147	09-08041-SS	103	09-2A013-SS-34	104*	09-M8100	91
01-M4070	91	01-N8163	147	09-08050-SS	103	09-2A014-185	151	09-M8101	91
01-M4071	91	01-N8167	147	09-08051-SS	103	09-2A024-185	152	09-M8110	91
01-M4080	91	01-NA013	92*	09-08060-SS	103	09-2A025-185-12	150	09-M8111	91
01-M4081	91	01-NA013-1	92*	09-08061-SS	103	09-2A025-185-34	150	09-M8120	91
01-M4090	91	01-NA013-12	92*	09-08070-SS	103	09-2A027	104	09-MA910	115
01-M4091	91	01-NA013-34	92*	09-14051-SS	93	09-2A027-185	150	09-MA919	115
01-M4100	91	01-NA014	115*	09-14060-SS	93	09-2A027-SS	94*	09-MA920	116
01-M4101	91	01-NA023-12	92*	09-14061-SS	93	09-2A053-080-SS-1	94*	09-MA929	116
01-M4110	91	01-NA023-34	92*	09-14070-SS	93	09-2A583	151*	09-N4042	147
01-M4111	91	01-NA024	116	09-14071-SS	93	09-2A583-185	151*	09-N4043	147
01-M4120	91	01-NA025-12	92*	09-14080-SS	93	09-2A913-67	150	09-N4045	147
01-M8051	91	01-NA025-34	92*	09-14081-SS	93	09-34012-185	149	09-N4047	147
01-M8060	91	01-NA027	92*	09-14090-SS	93	09-34013-185	149	09-N4072	147
01-M8061	91	01-NA053-080-12	92*	09-14091-SS	93	09-34015-185	149	09-N4073	147
01-M8070	91	01-NA126	92*	09-14100-SS	93	09-34016-185	149	09-N4075	147
01-M8071	91	01-NA313	92*	09-14101-SS	93	09-34017-185	149	09-N4076	147
01-M8080	91	01-NA583	151*	09-14110-SS	93	09-34032-185	149	09-N4142	147
01-M8081	91	01-P4041	103	09-14111-SS	93	09-34033-185	149	09-N4143	147
01-M8090	91	01-P4050	103	09-14120-SS	93	09-34035-185	149	09-N4147	147
01-M8091	91	01-P4051	103	09-18051-SS	93	09-34037-185	149	09-N4162	147
01-M8100	91	01-P4060	103	09-18060-SS	93	09-38012-185	149	09-N4163	147
01-M8101	91	01-P4061	103	09-18061-SS	93	09-38013-185	149	09-N4167	147
01-M8110	91	01-P4070	103	09-18070-SS	93	09-38015-185	149	09-N8042	147
01-M8111	91	01-P8041	103	09-18071-SS	93	09-38016-185	149	09-N8043	147
01-M8120	91	01-P8050	103	09-18080-SS	93	09-38017-185	149	09-N8045	147
01-MA911	115	01-P8051	103	09-18081-SS	93	09-38032-185	149	09-N8047	147
01-MA921	116	01-P8060	103	09-18090-SS	93	09-38033-185	149	09-N8072	147
01-N4042	147	01-P8061	103	09-18091-SS	93	09-38035-185	149	09-N8073	147
01-N4043	147	01-P8070	103	09-18100-SS	93	09-38037-185	149	09-N8075	147
01-N4045	147	01-S4042	147	09-18101-SS	93	09-M4051	91	09-N8076	147
01-N4047	147	01-S4043	147	09-18110-SS	93	09-M4060	91	09-N8142	147
01-N4072	147	01-S4045	147	09-18111-SS	93	09-M4061	91	09-N8143	147
01-N4073	147	01-S4047	147	09-18120-SS	93	09-M4070	91	09-N8147	147

Reference

Part Number	Pages	Part Number	Pages	Part Number	Pages	Part Number	Pages	Part Number	Pages
09-N8162	147	19-18061	105	19-68111	107	22-14073	71	22-3A013-20P	74
09-N8163	147	19-18070	105	19-68120	107	22-14075	71	22-3A013-25P	74
09-N8167	147	19-18071	105	19-68121	107	22-14076	71	22-3A013-32P	74
09-NA014	115*	19-18080	105	19-68130	107	22-14162	71	22-3A013-40P	74
09-NA024	116*	19-18081	105	19-68131	107	22-14163	71	22-3A023-34	74
09-NA025-12	92*	19-18090	105	19-68140	107	22-14167	71	22-3A027	74
09-NA025-34	92*	19-1A014	115	19-68141	107	22-18042	71	22-3A126	74
09-NA027	92*	19-1A024	116	19-68150	107	22-18043	71	22-3AB58	74
09-NA053-080-12	92*	19-1A711	115	19-68151	107	22-18045	71	22-64042	75
09-NA053-080-12-185	150	19-1A721	116	19-68160	107	22-18047	71	22-64043	75
09-P4041	103	19-1A910	115	19-68161	107	22-18072	71	22-64045	75
09-P4050	103	19-1A911	115	19-68170	107	22-18073	71	22-64047	75
09-P4051	103	19-1A920	116	19-68171	107	22-18075	71	22-64072	75
09-P4060	103	19-1A921	116	19-68181	107	22-18076	71	22-64073	75
09-P4061	103	19-1A925	116	19-68190	107	22-18162	71	22-64075	75
09-P4070	103	19-34061	109	19-68191	107	22-18163	71	22-64076	75
09-P8041	103	19-38061	109	19-68200	107	22-18167	71	22-64142	75
09-P8050	103	19-3A010-777	115	19-6A010-777	115	22-1A013-20P	72	22-64143	75
09-P8051	103	19-3A011-777	115	19-6A011-777	115	22-1A013-25P	72	22-64147	75
09-P8060	103	19-3A014	115	19-6A014	115	22-1A013-32P	72	22-64162	75
09-P8061	103	19-3A019-777	115	19-6A019-777	115	22-1A023-12	72	22-64163	75
09-P8070	103	19-3A020-777	116	19-6A020-777	116	22-1A027	72	22-64167	75
09-PA910	115	19-3A021-777	116	19-6A021-777	116	22-1A126	72	22-68042	75
09-PA911	115	19-3A024	116	19-6A024	116	22-1AB58	72	22-68043	75
09-PA919	115	19-3A029-777	116	19-6A029-777	116	22-34042	73	22-68045	75
09-PA920	116	19-64061	109	19-6A711	115	22-34043	73	22-68047	75
09-PA921	116	19-64091	107	19-6A721	116	22-34045	73	22-68072	75
09-PA929	116	19-64100	107	19-6A910	115	22-34047	73	22-68073	75
09-S4042	147	19-64101	107	19-6A911	115	22-34072	73	22-68075	75
09-S4043	147	19-64110	107	19-6A920	116	22-34073	73	22-68076	75
09-S4045	147	19-64111	107	19-6A921	116	22-34075	73	22-68142	75
09-S4047	147	19-64120	107	19-6A925	116	22-34076	73	22-68143	75
09-S4072	147	19-64121	107	19-9A010-777	115	22-34142	73	22-68147	75
09-S4073	147	19-64130	107	19-9A011-777	115	22-34143	73	22-68162	75
09-S4075	147	19-64131	107	19-9A019-777	115	22-34147	73	22-68163	75
09-S4076	147	19-64140	107	19-9A020-777	116	22-34162	73	22-68167	75
09-S4142	147	19-64141	107	19-9A021-777	116	22-34163	73	22-6A013-25P	76
09-S4143	147	19-64150	107	19-9A029-777	116	22-34167	73	22-6A013-32P	76
09-S4147	147	19-64151	107	1H1SS	98	22-38042	73	22-6A013-40P	76
09-S4162	147	19-64160	107	1PH1	36*	22-38043	73	22-6A027	76
09-S4163	147	19-64161	107	1PH114	36*	22-38045	73	22-6A126	76
09-S4167	147	19-64170	107	1PH12	36*	22-38047	73	22-6AB58	76
09-SA024	152	19-64171	107	1PH34	36*	22-38072	73	22-9A126	86
19-14051	105	19-64180	107	1PM514	26*	22-38073	73	26-20042-XX	83
19-14060	105	19-64181	107	1PM516	26*	22-38075	73	26-20043-XX	83
19-14061	105	19-64190	107	1PM518	26*	22-38076	73	26-20045-XX	83
19-14070	105	19-64191	107	1PM520	26*	22-38142	73	26-20047-XX	83
19-14071	105	19-64200	107	1PM522	26*	22-38143	73	26-20072-XX	83
19-14080	105	19-68061	109	22-14042	71	22-38147	73	26-20073-XX	83
19-14081	105	19-68091	107	22-14043	71	22-38162	73	26-20075-XX	83
19-14090	105	19-68100	107	22-14045	71	22-38162	73	26-20076-XX	83
19-18051	105	19-68101	107	22-14047	71	22-38163	73	26-20142-XX	83
19-18060	105	19-68110	107	22-14072	71	22-38167	73	26-20143-XX	83

Note: \* This part number is also displayed on other pages.

# Parts Index

Part Number	Pages	Part Number	Pages	Part Number	Pages	Part Number	Pages	Part Number	Pages
26-20147-XX	83	26-26076-XX	83	26-34042	84	26-61076-XXXX	85	26-6A126	85
26-20162-XX	83	26-26142-XX	83	26-34043	84	26-61142-XXXX	85	26-90042-XX	86
26-20163-XX	83	26-26143-XX	83	26-34045	84	26-61143-XXXX	85	26-90043-XX	86
26-20167-XX	83	26-26147-XX	83	26-34047	84	26-61147-XXXX	85	26-90045-XX	86
26-21042-XXXX	83	26-26162-XX	83	26-34072	84	26-61162-XXXX	85	26-90047-XX	86
26-21043-XXXX	83	26-26163-XX	83	26-34073	84	26-61163-XXXX	85	26-90072-XX	86
26-21045-XXXX	83	26-26167-XX	83	26-34075	84	26-61167-XXXX	85	26-90073-XX	86
26-21047-XXXX	83	26-2A023-1	83	26-34076	84	26-63042-XXXX	85	26-90075-XX	86
26-21072-XXXX	83	26-2A023-12	83	26-34142	84	26-63043-XXXX	85	26-90076-XX	86
26-21073-XXXX	83	26-2A023-34	83	26-34143	84	26-63045-XXXX	85	26-90142-XX	86
26-21075-XXXX	83	26-2A126	83	26-34147	84	26-63047-XXXX	85	26-90143-XX	86
26-21076-XXXX	83	26-30042-XX	84	26-34162	84	26-63072-XXXX	85	26-90147-XX	86
26-21142-XXXX	83	26-30043-XX	84	26-34163	84	26-63073-XXXX	85	26-90162-XX	86
26-21143-XXXX	83	26-30045-XX	84	26-34167	84	26-63075-XXXX	85	26-90163-XX	86
26-21147-XXXX	83	26-30047-XX	84	26-36042-XX	84	26-63076-XXXX	85	26-90167-XX	86
26-21162-XXXX	83	26-30072-XX	84	26-36043-XX	84	26-63142-XXXX	85	26-93042-XXXX	86
26-21163-XXXX	83	26-30073-XX	84	26-36045-XX	84	26-63143-XXXX	85	26-93043-XXXX	86
26-21167-XXXX	83	26-30075-XX	84	26-36047-XX	84	26-63147-XXXX	85	26-93045-XXXX	86
26-23042-XXXX	83	26-30076-XX	84	26-36072-XX	84	26-63162-XXXX	85	26-93047-XXXX	86
26-23043-XXXX	83	26-30142-XX	84	26-36073-XX	84	26-63163-XXXX	85	26-93072-XXXX	86
26-23045-XXXX	83	26-30143-XX	84	26-36075-XX	84	26-63167-XXXX	85	26-93073-XXXX	86
26-23047-XXXX	83	26-30147-XX	84	26-36076-XX	84	26-64042	85	26-93075-XXXX	86
26-23072-XXXX	83	26-30162-XX	84	26-36142-XX	84	26-64043	85	26-93076-XXXX	86
26-23073-XXXX	83	26-30163-XX	84	26-36143-XX	84	26-64045	85	26-93142-XXXX	86
26-23075-XXXX	83	26-30167-XX	84	26-36147-XX	84	26-64047	85	26-93143-XXXX	86
26-23076-XXXX	83	26-31042-XXXX	84	26-36162-XX	84	26-64072	85	26-93147-XXXX	86
26-23142-XXXX	83	26-31043-XXXX	84	26-36163-XX	84	26-64073	85	26-93162-XXXX	86
26-23143-XXXX	83	26-31045-XXXX	84	26-36167-XX	84	26-64075	85	26-93163-XXXX	86
26-23147-XXXX	83	26-31047-XXXX	84	26-3A023-1	84	26-64076	85	26-93167-XXXX	86
26-23162-XXXX	83	26-31072-XXXX	84	26-3A023-12	84	26-64142	85	26-94042	86
26-23163-XXXX	83	26-31073-XXXX	84	26-3A023-34	84	26-64143	85	26-94043	86
26-23167-XXXX	83	26-31075-XXXX	84	26-3A126	84	26-64147	85	26-94045	86
26-24042	83	26-31076-XXXX	84	26-60042-XX	85	26-64162	85	26-94047	86
26-24043	83	26-31142-XXXX	84	26-60043-XX	85	26-64163	85	26-94072	86
26-24045	83	26-31143-XXXX	84	26-60045-XX	85	26-64167	85	26-94073	86
26-24047	83	26-31147-XXXX	84	26-60047-XX	85	26-66042-XX	85	26-94075	86
26-24072	83	26-31162-XXXX	84	26-60072-XX	85	26-66043-XX	85	26-94076	86
26-24073	83	26-31163-XXXX	84	26-60073-XX	85	26-66045-XX	85	26-94142	86
26-24075	83	26-31167-XXXX	84	26-60075-XX	85	26-66047-XX	85	26-94143	86
26-24076	83	26-33042-XXXX	84	26-60076-XX	85	26-66072-XX	85	26-94147	86
26-24142	83	26-33043-XXXX	84	26-60142-XX	85	26-66073-XX	85	26-94162	86
26-24143	83	26-33045-XXXX	84	26-60143-XX	85	26-66075-XX	85	26-94163	86
26-24147	83	26-33047-XXXX	84	26-60147-XX	85	26-66076-XX	85	26-94167	86
26-24162	83	26-33072-XXXX	84	26-60162-XX	85	26-66142-XX	85	26-9A023-1	86
26-24163	83	26-33073-XXXX	84	26-60163-XX	85	26-66143-XX	85	26-9A023-112	86
26-24167	83	26-33075-XXXX	84	26-60167-XX	85	26-66147-XX	85	26-9A023-114	86
26-26042-XX	83	26-33076-XXXX	84	26-61042-XXXX	85	26-66162-XX	85	26-9A023-2	86
26-26043-XX	83	26-33142-XXXX	84	26-61043-XXXX	85	26-66163-XX	85	26-9A126	86
26-26045-XX	83	26-33143-XXXX	84	26-61045-XXXX	85	26-66167-XX	85	2H1	46*
26-26047-XX	83	26-33147-XXXX	84	26-61047-XXXX	85	26-6A023-1	85	2H112	46*
26-26072-XX	83	26-33162-XXXX	84	26-61072-XXXX	85	26-6A023-112	85	2H114	46*
26-26073-XX	83	26-33163-XXXX	84	26-61073-XXXX	85	26-6A023-114	85	2H2	46*
26-26075-XX	83	26-33167-XXXX	84	26-61075-XXXX	85	26-6A023-2	85	2H212	46*

Reference

Part Number	Pages	Part Number	Pages	Part Number	Pages	Part Number	Pages	Part Number	Pages
2PH112	46*	31-1A921	116	31-3A010	47*	31-681736-K07	135	31-94233-K16	137
2PH2	46*	31-1AB26	47*	31-3A010-B	47*	31-68182-K14	135	31-94237-K16	137
2PH212	46*	31-1AC26	47*	31-3A010-T	47*	31-68183-K14	135	31-94242-K04	137
31-111	36*	31-1AF26	47*	31-3A011-380	47*	31-68187-K14	135	31-94243-K04	137
31-14172-K07	131	31-1AN26	47*	31-3A014	47*	31-68232-K16	135	31-94245-K04	137
31-14173-K07	131	31-1AR26	47*	31-3A020	48*	31-68233-K16	135	31-94247-K04	137
31-14175-K07	131	31-211	46*	31-3A020-B	48*	31-68237-K16	135	31-98172-K07	137
31-14176-K07	131	31-2A126	46*	31-3A020-T	48*	31-68242-K04	135	31-98173-K07	137
31-14182-K14	131	31-311	106*	31-3A021-380	48*	31-68243-K04	135	31-98175-K07	137
31-14183-K14	131	31-34172-K07	133	31-3A024	48*	31-68245-K04	135	31-98176-K07	137
31-14187-K14	131	31-34173-K07	133	31-3A026	115	31-68247-K04	135	31-98182-K14	137
31-14232-K16	131	31-34175-K07	133	31-3A053-080-1	38*	31-6A010	47*	31-98183-K14	137
31-14233-K16	131	31-34176-K07	133	31-3A053-080-114	38	31-6A010-B	47*	31-98187-K14	137
31-14237-K16	131	31-34182-K14	133	31-3A053-080-12	38	31-6A010-C-B	47	31-98232-K16	137
31-14242-K04	131	31-34183-K14	133	31-3A053-080-34	38	31-6A010-C-T	47	31-98233-K16	137
31-14243-K04	131	31-34187-K14	133	31-3A126	38*	31-6A010-T	47*	31-98237-K16	137
31-14245-K04	131	31-34232-K16	133	31-3A226	38*	31-6A011	47*	31-98242-K04	137
31-14247-K04	131	31-34233-K16	133	31-3A583	47*	31-6A011-C	47	31-98243-K04	137
31-18172-K07	131	31-34237-K16	133	31-3A677	47*	31-6A014	47*	31-98245-K04	137
31-18173-K07	131	31-34242-K04	133	31-3A910	115	31-6A020	48*	31-98247-K04	137
31-18175-K07	131	31-34243-K04	133	31-3A910-263	115	31-6A020-B	48*	31-9A010	47*
31-18176-K07	131	31-34245-K04	133	31-3A911	115	31-6A020-C	48	31-9A010-B	47*
31-18182-K14	131	31-34247-K04	133	31-3A911-172	115	31-6A020-C-B	48	31-9A010-T	47*
31-18183-K14	131	31-34931	113	31-3A919	115	31-6A020-C-T	48	31-9A014	47*
31-18187-K14	131	31-34940	113	31-3A920	116	31-6A020-T	48*	31-9A020	48*
31-18232-K16	131	31-34941	113	31-3A920-263	116	31-6A021	48*	31-9A020-B	48*
31-18233-K16	131	31-34950	113	31-3A921	116	31-6A021-C	48	31-9A020-T	48*
31-18237-K16	131	31-34951	113	31-3A921-172	116	31-6A024	48*	31-9A024	48*
31-18242-K04	131	31-34960	113	31-3A929	116	31-6A026	115*	31-9A026	115*
31-18243-K04	131	31-34961	113	31-3AB26	47*	31-6A053-080-1	40*	31-9A053-080-112	44
31-18245-K04	131	31-34970	113	31-3AC26	47*	31-6A053-080-112	40*	31-9A053-080-114	44
31-18247-K04	131	31-38172-K07	133	31-3AF26	47*	31-6A053-080-114	40*	31-9A053-080-2	44*
31-1A010	47*	31-38173-K07	133	31-3AM26	115	31-6A053-080-2	40*	31-9A053-080-212	44
31-1A010-B	47*	31-38175-K07	133	31-3AN26	47*	31-6A110-C	47	31-9A126	44*
31-1A010-T	47*	31-38176-K07	133	31-3AR26	47*	31-6A126	40*	31-9A583	47*
31-1A011	47*	31-38182-K14	133	31-611	40*	31-6A226	40*	31-9AB26	47*
31-1A014	47*	31-38183-K14	133	31-64172-K07	135	31-6A583	47*	31-9AC26	47*
31-1A020	48*	31-38187-K14	133	31-64173-K07	135	31-6A677	47*	31-9AF26	47*
31-1A020-B	48*	31-38232-K16	133	31-64175-K07	135	31-6AB26	47*	31-9AN26	47*
31-1A020-T	48*	31-38233-K16	133	31-64176-K07	135	31-6AC26	47*	31-9AR26	47*
31-1A021	48*	31-38237-K16	133	31-64182-K14	135	31-6AF26	47*	33-14042	35
31-1A024	48*	31-38242-K04	133	31-64183-K14	135	31-6AM26	115*	33-14043	35
31-1A053-080-1	36*	31-38243-K04	133	31-64187-K14	135	31-6AN26	47*	33-14045	35
31-1A053-080-114	36	31-38245-K04	133	31-64232-K16	135	31-6AR26	47*	33-14047	35
31-1A053-080-12	36	31-38247-K04	133	31-64233-K16	135	31-911	44*	33-14072	35
31-1A053-080-34	36	31-38931	113	31-64237-K16	135	31-94172-K07	137	33-14073	35
31-1A126	36*	31-38940	113	31-64242-K04	135	31-94173-K07	137	33-14075	35
31-1A226	36*	31-38941	113	31-64243-K04	135	31-94175-K07	137	33-14076	35
31-1A583	47*	31-38950	113	31-64245-K04	135	31-94176-K07	137	33-14142	35
31-1A677	47*	31-38951	113	31-64247-K04	135	31-94182-K14	137	33-14143	35
31-1A910	115	31-38960	113	31-68172-K07	135	31-94183-K14	137	33-14147	35
31-1A911	115	31-38961	113	31-68173-K07	135	31-94187-K14	137	33-14162	35
31-1A920	116	31-38970	113	31-68175-K07	135	31-94232-K16	137	33-14163	35

Note: \* This part number is also displayed on other pages.

# Parts Index

Part Number	Pages	Part Number	Pages	Part Number	Pages	Part Number	Pages	Part Number	Pages
33-14167	35	33-38045	37	33-67076-22X	160	33-97046-22X	160	37-04251-SS	101
33-18042	35	33-38047	37	33-67142-12X	160	33-97047-42X	160	37-04260-SS	101
33-18043	35	33-38072	37	33-67143-32X	160	33-97072-12X	160	37-04261-SS	101
33-18045	35	33-38073	37	33-67146-22X	160	33-97076-22X	160	37-04270-SS	101
33-18047	35	33-38075	37	33-67147-42X	160	33-97142-12X	160	37-04271-SS	101
33-18072	35	33-38076	37	33-67162-12X	160	33-97143-32X	160	37-04280-SS	101
33-18073	35	33-38142	37	33-67163-32X	160	33-97146-22X	160	37-04281-SS	101
33-18075	35	33-38143	37	33-67166-22X	160	33-97147-42X	160	37-04290-SS	101
33-18076	35	33-38147	37	33-67167-42X	160	33-97162-12X	160	37-04291-SS	101
33-18142	35	33-38162	37	33-68042	39	33-97163-32X	160	37-04300-SS	101
33-18143	35	33-38163	37	33-68043	39	33-97166-22X	160	37-04301-SS	101
33-18147	35	33-38167	37	33-68045	39	33-97167-42X	160	37-04310-SS	101
33-18162	35	33-38531	111	33-68047	39	33-98042	43	37-04311-SS	101
33-18163	35	33-38540	111	33-68072	39	33-98043	43	37-04320-SS	101
33-18167	35	33-38541	111	33-68073	39	33-98045	43	37-04321-SS	101
33-34042	37	33-38550	111	33-68075	39	33-98047	43	37-04330-SS	101
33-34043	37	33-38551	111	33-68076	39	33-98072	43	37-04331-SS	101
33-34045	37	33-38560	111	33-68142	39	33-98073	43	37-04340-SS	101
33-34047	37	33-38561	111	33-68143	39	33-98075	43	37-04341-SS	101
33-34072	37	33-38570	111	33-68147	39	33-98076	43	37-04350-SS	101
33-34073	37	33-64042	39	33-68162	39	33-98142	43	37-04351-SS	101
33-34075	37	33-64043	39	33-68163	39	33-98143	43	37-04360-SS	101
33-34076	37	33-64045	39	33-68167	39	33-98147	43	37-04361-SS	101
33-34142	37	33-64047	39	33-68172-C-K07	41	33-98162	43	37-04370-SS	101
33-34143	37	33-64072	39	33-68173-C-K07	41	33-98163	43	37-08121-SS	97
33-34147	37	33-64073	39	33-68175-C-K07	41	33-98167	43	37-08130-SS	97
33-34162	37	33-64075	39	33-68176-C-K07	41	36-9A126	42	37-08131-SS	97
33-34163	37	33-64076	39	33-68182-C-K14	41	37-04121-SS	97	37-08140-SS	97
33-34167	37	33-64142	39	33-68183-C-K14	41	37-04130-SS	97	37-08141-SS	97
33-34531	111	33-64143	39	33-68187-C-K14	41	37-04131-SS	97	37-08150-SS	97
33-34540	111	33-64147	39	33-68232-C-K16	41	37-04140-SS	97	37-08151-SS	97
33-34541	111	33-64162	39	33-68233-C-K16	41	37-04141-SS	97	37-08160-SS	97
33-34550	111	33-64163	39	33-68237-C-K16	41	37-04150-SS	97	37-08161-SS	97
33-34551	111	33-64167	39	33-68242-C-K04	41	37-04151-SS	97	37-08170-SS	97
33-34560	111	33-64172-C-K07	41	33-68243-C-K04	41	37-04160-SS	97	37-08171-SS	97
33-34561	111	33-64173-C-K07	41	33-68245-C-K04	41	37-04161-SS	97	37-08180-SS	97
33-34570	111	33-64175-C-K07	41	33-68247-C-K04	41	37-04170-SS	97	37-08181-SS	97
33-37042-12X	160	33-64176-C-K07	41	33-94042	43	37-04171-SS	97	37-08190-SS	97
33-37043-32X	160	33-64182-C-K14	41	33-94043	43	37-04180-SS	97	37-08191-SS	97
33-37046-22X	160	33-64183-C-K14	41	33-94045	43	37-04181-SS	97	37-08200-SS	97
33-37047-42X	160	33-64187-C-K14	41	33-94047	43	37-04190-SS	97	37-08201-SS	97
33-37072-12X	160	33-64232-C-K16	41	33-94072	43	37-04191-SS	97	37-08210-SS	97
33-37076-22X	160	33-64233-C-K16	41	33-94073	43	37-04200-SS	97	37-08211-SS	97
33-37142-12X	160	33-64237-C-K16	41	33-94075	43	37-04201-SS	97	37-08220-SS	97
33-37143-32X	160	33-64242-C-K04	41	33-94076	43	37-04210-SS	97	37-08221-SS	97
33-37146-22X	160	33-64243-C-K04	41	33-94142	43	37-04211-SS	97	37-08230-SS	97
33-37147-42X	160	33-64245-C-K04	41	33-94143	43	37-04220-SS	97	37-08231-SS	97
33-37162-12X	160	33-64247-C-K04	41	33-94147	43	37-04221-SS	97	37-08240-SS	97
33-37163-32X	160	33-67042-12X	160	33-94162	43	37-04230-SS	97	37-08241-SS	101
33-37166-22X	160	33-67043-32X	160	33-94163	43	37-04231-SS	97	37-08250-SS	101
33-37167-42X	160	33-67046-22X	160	33-94167	43	37-04240-SS	97	37-08251-SS	101
33-38042	37	33-67047-42X	160	33-97042-12X	160	37-04241-SS	101	37-08260-SS	101
33-38043	37	33-67072-12X	160	33-97043-32X	160	37-04250-SS	101	37-08261-SS	101

Reference

Part Number	Pages	Part Number	Pages	Part Number	Pages	Part Number	Pages	Part Number	Pages
37-08270-SS	101	37-34531	111	37-67147-42X	160	37-97142-12X	160	39-2A220	48*
37-08271-SS	101	37-34540	111	37-67162-12X	160	37-97143-32X	160	39-2A486	46*
37-08280-SS	101	37-34541	111	37-67163-32X	160	37-97146-22X	160	39-2A523	47*
37-08281-SS	101	37-34550	111	37-67166-22X	160	37-97147-42X	160	39-2A583	47*
37-08290-SS	101	37-34551	111	37-67167-42X	160	37-97162-12X	160	39-2A677	47*
37-08291-SS	101	37-34560	111	37-68042	39	37-97163-32X	160	39-2AB26	47*
37-08300-SS	101	37-34561	111	37-68043	39	37-97166-22X	160	39-2AC26	47*
37-08301-SS	101	37-34570	111	37-68045	39	37-97167-42X	160	39-2AF26	47*
37-08310-SS	101	37-38531	111	37-68047	39	37-98042	43	39-2AN26	47*
37-08311-SS	101	37-38540	111	37-68072	39	37-98043	43	39-2AR26	47*
37-08320-SS	101	37-38541	111	37-68073	39	37-98045	43	39-34931	113
37-08321-SS	101	37-38550	111	37-68075	39	37-98047	43	39-34940	113
37-08330-SS	101	37-38551	111	37-68076	39	37-98072	43	39-34941	113
37-08331-SS	101	37-38560	111	37-68142	39	37-98073	43	39-34950	113
37-08340-SS	101	37-38561	111	37-68143	39	37-98075	43	39-34951	113
37-08341-SS	101	37-38570	111	37-68147	39	37-98076	43	39-34960	113
37-08350-SS	101	37-64042	39	37-68162	39	37-98142	43	39-34961	113
37-08351-SS	101	37-64043	39	37-68163	39	37-98143	43	39-34970	113
37-08360-SS	101	37-64045	39	37-68167	39	37-98147	43	39-38931	113
37-08361-SS	101	37-64047	39	37-68172-C-K07	41	37-98162	43	39-38940	113
37-08370-SS	101	37-64072	39	37-68173-C-K07	41	37-98163	43	39-38941	113
37-24042	45	37-64073	39	37-68175-C-K07	41	39-1A053-080-SS-1	98	39-38950	113
37-24043	45	37-64075	39	37-68176-C-K07	41	39-24232-K16	139	39-38951	113
37-24045	45	37-64076	39	37-68182-C-K14	41	39-24233-K16	139	39-38960	113
37-24047	45	37-64142	39	37-68183-C-K14	41	39-24237-K16	139	39-38961	113
37-24072	45	37-64143	39	37-68187-C-K14	41	39-24242-K04	139	39-38970	113
37-24073	45	37-64147	39	37-68232-C-K16	41	39-24243-K04	139	39-3A053-080-1	106
37-24075	45	37-64162	39	37-68233-C-K16	41	39-24245-K04	139	39-3A053-080-SS-1	102
37-24076	45	37-64163	39	37-68237-C-K16	41	39-24247-K04	139	39-64172-K07	135
37-24162	45	37-64167	39	37-68242-C-K04	41	39-28232-K16	139	39-64173-K07	135
37-24163	45	37-64172-C-K07	41	37-68243-C-K04	41	39-28233-K16	139	39-64175-K07	135
37-24167	45	37-64173-C-K07	41	37-68245-C-K04	41	39-28237-K16	139	39-64176-K07	135
37-27042-12X	160	37-64175-C-K07	41	37-68247-C-K04	41	39-28242-K04	139	39-64232-K16	135
37-27043-32X	160	37-64176-C-K07	41	37-94042	43	39-28243-K04	139	39-64233-K16	135
37-27046-22X	160	37-64182-C-K14	41	37-94043	43	39-28245-K04	139	39-64237-K16	135
37-27047-42X	160	37-64183-C-K14	41	37-94045	43	39-28247-K04	139	39-64242-K04	135
37-27072-12X	160	37-64187-C-K14	41	37-94047	43	39-2A010	47*	39-64243-K04	135
37-27076-22X	160	37-64232-C-K16	41	37-94072	43	39-2A010-B	47*	39-64245-K04	135
37-27162-12X	160	37-64233-C-K16	41	37-94073	43	39-2A010-T	47*	39-64247-K04	135
37-27163-32X	160	37-64237-C-K16	41	37-94075	43	39-2A011	47*	39-68172-K07	135
37-27166-22X	160	37-64242-C-K04	41	37-94076	43	39-2A014	47*	39-68173-K07	135
37-27167-42X	160	37-64243-C-K04	41	37-94142	43	39-2A014-486	46*	39-68175-K07	135
37-28042	45	37-64245-C-K04	41	37-94143	43	39-2A020	48*	39-68176-K07	135
37-28043	45	37-64247-C-K04	41	37-94147	43	39-2A020-B	48*	39-68232-K16	135
37-28045	45	37-67042-12X	160	37-94162	43	39-2A020-T	48*	39-68233-K16	135
37-28047	45	37-67043-32X	160	37-94163	43	39-2A021	48*	39-68237-K16	135
37-28072	45	37-67046-22X	160	37-94167	43	39-2A024	48*	39-68242-K04	135
37-28073	45	37-67047-42X	160	37-97042-12X	160	39-2A024-486	46*	39-68243-K04	135
37-28075	45	37-67072-12X	160	37-97043-32X	160	39-2A026	115*	39-68245-K04	135
37-28076	45	37-67076-22X	160	37-97046-22X	160	39-2A053-080-112	46	39-68247-K04	135
37-28162	45	37-67142-12X	160	37-97047-42X	160	39-2A053-080-2	46	39-6A014	47*
37-28163	45	37-67143-32X	160	37-97072-12X	160	39-2A053-080-212	46*	39-6A024	48*
37-28167	45	37-67146-22X	160	37-97076-22X	160	39-2A110	47*	39-6A053-080-1	40*

Note: \* This part number is also displayed on other pages.

# Parts Index

Part Number	Pages	Part Number	Pages	Part Number	Pages	Part Number	Pages	Part Number	Pages
39-6A053-080-112	40*	3H112	56	454 A15 C	127	47-3A020	123	49-48046	121
39-6A053-080-114	40*	3H114	56*	454 A15 D	127	47-3A021	123	49-48047	121
39-6A053-080-2	40*	3H12	56*	454 A18 C	127	47-3A021N	123	49-48142	121
39-6A110	47*	3H1SS	102	454 A18 D	127	47-3A024	123	49-48143	121
39-6A220	48	3H34	56*	454 A24 C	127	47-3A029	123	49-48145	121
39-6A220-C	48	3PH1	38*	454 A24 D	127	47-3A126	122	49-48146	121
39-6A523	47*	3PH114	38*	454 A30 C	127	47-3A913-XXX	122	49-48147	121
39-6A583	47*	3PH12	38*	454 A30 D	127	47-3A925	122*	49-4A010	123
39-6A677	47*	3PH34	38*	454 A40 C	127	49-34042	121	49-4A011	123
39-94061	109	3PM514	28*	454 A40 D	127	49-34043	121	49-4A011N	123
39-94172-K07	137	3PM516	28*	454 A753	127	49-34045	121	49-4A013-XXX	122
39-94173-K07	137	3PM518	28*	454 A95 C	127	49-34046	121	49-4A014	123
39-94175-K07	137	3PM520	28*	454 A95 D	127	49-34047	121	49-4A019	123
39-94176-K07	137	3PM522	28*	4544 001 P80	127	49-34142	121	49-4A020	123
39-94232-K16	137	4-0201-A	161	4544 002 P80	127	49-34143	121	49-4A021	123
39-94233-K16	137	4-0201-B	161	4544 003 P80	127	49-34145	121	49-4A021N	123
39-94237-K16	137	4-0201-C	161	4544 00M P80	127	49-34146	121	49-4A024	123
39-94242-K04	137	4-0201-D	161	4544 00N P80	127	49-34147	121	49-4A029	123
39-94243-K04	137	4-0301-E	161	4544 00P P80	127	49-38042	121	49-4A126	122
39-94245-K04	137	4-0301-F	161	4544 00T P80	127	49-38042	121	49-4A913-XXX	122
39-94247-K04	137	4-0301-G	161	4548 001 P80	127	49-38043	121	49-4A925	122
39-98022-K14	137	4-0501-H	161	4548 002 P80	127	49-38045	121	49-64042	121
39-98023-K14	137	4-0501-J	161	4548 003 P80	127	49-38046	121	49-64043	121
39-98027-K14	137	4-2301-A	161	4548 00M P80	127	49-38047	121	49-64045	121
39-98061	109	4-2301-B	161	4548 00N P80	127	49-38142	121	49-64046	121
39-98172-K07	137	4-2301-C	161	4548 00P P80	127	49-38143	121	49-64047	121
39-98173-K07	137	4-2301-D	161	4548 00T P80	127	49-38145	121	49-64142	121
39-98175-K07	137	4-2401-A	161	47-34042	121	49-38146	121	49-64143	121
39-98176-K07	137	4-2401-B	161	47-34043	121	49-38147	121	49-64145	121
39-98232-K16	137	4-2401-C	161	47-34045	121	49-3A011	122	49-64146	121
39-98233-K16	137	4-2401-D	161	47-34046	121	49-3A013-XXX	122	49-64147	121
39-98237-K16	137	4-2901-A	161	47-34047	121	49-3A014	123	49-68042	121
39-98242-K04	137	4-2901-B	161	47-34142	121	49-3A020	123	49-68043	121
39-98243-K04	137	4-2901-C	161	47-34143	121	49-3A021	123	49-68045	121
39-98245-K04	137	4-2901-D	161	47-34145	121	49-3A021N	123	49-68046	121
39-98247-K04	137	4-3301-E	161	47-34146	121	49-3A024	123	49-68047	121
39-9A011	47*	4-3301-F	161	47-34147	121	49-3A029	123	49-68142	121
39-9A014	47*	4-3301-G	161	47-38042	121	49-3A126	122	49-68143	121
39-9A014-486	108*	4-3401-E	161	47-38043	121	49-3A913-XXX	122	49-68145	121
39-9A021	48*	4-3401-F	161	47-38045	121	49-3A925	122*	49-68146	121
39-9A024	48*	4-3401-G	161	47-38046	121	49-44042	121	49-68147	121
39-9A024-486	108*	4-3901-E	161	47-38047	121	49-44043	121	49-6A010	123
39-9A053-080-112	44	4-3901-F	161	47-38142	121	49-44045	121	49-6A011	123
39-9A053-080-114	44	4-3901-G	161	47-38143	121	49-44046	121	49-6A011N	123
39-9A053-080-2	44*	4-5301-H	161	47-38145	121	49-44047	121	49-6A013-XXX	122
39-9A053-080-212	44	4-5301-J	161	47-38146	121	49-44142	121	49-6A014	123
39-9A110	47*	4-5401-H	161	47-38147	121	49-44143	121	49-6A019	123
39-9A220	142	4-5401-J	161	47-3A010	123	49-44145	121	49-6A020	123
39-9A486	44*	4-5901-H	161	47-3A011	123	49-44146	121	49-6A021	123
39-9A523	47*	4-5901-J	161	47-3A011N	123	49-44147	121	49-6A021N	123
39-9A583	47*	454 A027	127	47-3A013-XXX	122	49-48042	121	49-6A024	123
39-9A677	47*	454 A12	127	47-3A014	122	49-48043	121	49-6A029	123
3H1	56*	454 A12 D	127	47-3A019	122	49-48045	121	49-6A126	123

Part Number	Pages	Part Number	Pages	Part Number	Pages	Part Number	Pages	Part Number	Pages
49-6A913-XXX	122	61-1A126	24	61-6A023-34	28*	63-04331	99	63-08350	99
49-6A925	123	61-1A313	24	61-6A024	30	63-04340	99	63-08351	99
5-0205-A	162	61-1A346	24*	61-6A027	28*	63-04341	99	63-08360	99
5-0205-B	162	61-1A583	29*	61-6A053-080-1	28*	63-04350	99	63-08361	99
5-0205-C	162	61-1A826	24	61-6A053-080-114	28	63-04351	99	63-08370	99
5-0205-D	162	61-1AB26	29*	61-6A053-080-12	28	63-04360	99	63-14042	23
5-0205-K	162	61-1AC26	29*	61-6A053-080-34	28	63-04361	99	63-14043	23
5-0206-A	162	61-1AF26	29*	61-6A126	28*	63-04370	99	63-14045	23
5-0206-B	162	61-1AM26	115*	61-6A346	28*	63-08121	95	63-14047	23
5-0206-C	162	61-1AR26	29*	61-6A473	28*	63-08130	95	63-14072	23
5-0206-D	162	61-3A010	29	61-6A826	28*	63-08131	95	63-14073	23
5-0206-K	162	61-3A010-B	29	63-04121	95	63-08140	95	63-14075	23
5-0207-A	162	61-3A010-T	29	63-04130	95	63-08141	95	63-14076	23
5-0207-B	162	61-3A013	26*	63-04131	95	63-08150	95	63-14162	23
5-0207-C	162	61-3A013-1	26*	63-04140	95	63-08151	95	63-14163	23
5-0207-D	162	61-3A013-114	26*	63-04141	95	63-08160	95	63-14167	23
5-0207-K	162	61-3A013-12	26*	63-04150	95	63-08161	95	63-18042	23
5-2105-A	162	61-3A013-34	26*	63-04151	95	63-08170	95	63-18043	23
5-2105-B	162	61-3A014	29*	63-04160	95	63-08171	95	63-18045	23
5-2105-C	162	61-3A020	30	63-04161	95	63-08180	95	63-18047	23
5-2105-D	162	61-3A020-B	30	63-04170	95	63-08181	95	63-18072	23
5-2105-K	162	61-3A020-T	30	63-04171	95	63-08190	95	63-18073	23
5-2106-A	162	61-3A023-12	26*	63-04180	95	63-08191	95	63-18075	23
5-2106-B	162	61-3A023-34	26*	63-04181	95	63-08200	95	63-18076	23
5-2106-C	162	61-3A024	30*	63-04190	95	63-08201	95	63-18162	23
5-2106-D	162	61-3A027	26*	63-04191	95	63-08210	95	63-18163	23
5-2106-K	162	61-3A053-080-1	26*	63-04200	95	63-08211	95	63-18167	23
5-2107-A	162	61-3A053-080-114	26	63-04201	95	63-08220	95	63-34042	25
5-2107-B	162	61-3A053-080-12	26	63-04210	95	63-08221	95	63-34043	25
5-2107-C	162	61-3A053-080-34	26	63-04211	95	63-08230	95	63-34045	25
5-2107-D	162	61-3A126	26*	63-04220	95	63-08231	95	63-34047	25
5-2107-K	162	61-3A346	26*	63-04221	95	63-08240	95	63-34072	25
61-1A010	29	61-3A826	26*	63-04230	95	63-08241	99	63-34073	25
61-1A010-B	29	61-3AB26	29*	63-04231	95	63-08250	99	63-34075	25
61-1A010-T	29	61-3AC26	29*	63-04240	95	63-08251	99	63-34076	25
61-1A011	29	61-3AF26	29*	63-04241	99	63-08260	99	63-34142	25
61-1A013	24	61-3AM26	115*	63-04250	99	63-08261	99	63-34143	25
61-1A013-1	24	61-3AN26	29*	63-04251	99	63-08270	99	63-34147	25
61-1A013-12	24	61-3AR26	29*	63-04260	99	63-08271	99	63-34162	25
61-1A013-34	24	61-6A010	29	63-04261	99	63-08280	99	63-34163	25
61-1A014	29	61-6A010-B	29	63-04270	99	63-08281	99	63-34167	25
61-1A020	30	61-6A010-T	29	63-04271	99	63-08290	99	63-38042	25
61-1A020-B	30	61-6A013	28*	63-04280	99	63-08291	99	63-38043	25
61-1A020-T	30	61-6A013-1	28*	63-04281	99	63-08300	99	63-38045	25
61-1A021	30	61-6A013-114	28*	63-04290	99	63-08301	99	63-38047	25
61-1A023-12	24	61-6A013-12	28*	63-04291	99	63-08310	99	63-38072	25
61-1A023-34	24	61-6A013-34	28*	63-04300	99	63-08311	99	63-38073	25
61-1A024	30	61-6A014	29*	63-04301	99	63-08320	99	63-38075	25
61-1A027	24	61-6A020	30	63-04310	99	63-08321	99	63-38076	25
61-1A053-080-1	24	61-6A020-B	30	63-04311	99	63-08330	99	63-38142	25
61-1A053-080-114	24	61-6A020-T	30	63-04320	99	63-08331	99	63-38143	25
61-1A053-080-12	24	61-6A023-1	28*	63-04321	99	63-08340	99	63-38147	25
61-1A053-080-34	24	61-6A023-12	28*	63-04330	99	63-08341	99	63-38162	25

Note: \* This part number is also displayed on other pages.



# Parts Index

Part Number	Pages	Part Number	Pages	Part Number	Pages	Part Number	Pages	Part Number	Pages
63-38163	25	89-34143	55	89-64075	57	89-94047	59	9H112	44*
63-38167	25	89-34147	55	89-64076	57	89-94072	59	9H114	44*
63-64042	27	89-34162	55	89-64142	57	89-94073	59	9H2	44*
63-64043	27	89-34163	55	89-64143	57	89-94075	59	9H34	44*
63-64045	27	89-34167	55	89-64147	57	89-94076	59	9PH1	44*
63-64047	27	89-38042	55	89-64162	57	89-94142	59	9PH112	44*
63-64072	27	89-38043	55	89-64163	57	89-94143	59	9PH114	44*
63-64073	27	89-38045	55	89-64167	57	89-94147	59	9PH2	44*
63-64075	27	89-38047	55	89-68042	57	89-94162	59	9PH34	44*
63-64076	27	89-38072	55	89-68043	57	89-94163	59	9PM622	44*
63-64142	27	89-38073	55	89-68045	57	89-94167	59	9PM625	44*
63-64143	27	89-38075	55	89-68047	57	89-98042	59	9PM627	44*
63-64147	27	89-38076	55	89-68072	57	89-98043	59	9PM629	44*
63-64162	27	89-38142	55	89-68073	57	89-98045	59	CPF403	123
63-64163	27	89-38143	55	89-68075	57	89-98047	59	CPF405	123
63-64167	27	89-38147	55	89-68076	57	89-98072	59	DN16R	106
63-68042	27	89-38162	55	89-68142	57	89-98073	59	DN63R	108*
63-68043	27	89-38163	55	89-68143	57	89-98075	59	DS1PC	36*
63-68045	27	89-38167	55	89-68147	57	89-98076	59	DS2MC	46*
63-68047	27	89-3A010	61	89-68162	57	89-98142	59	DS3PC	38*
63-68072	27	89-3A010-172	61	89-68163	57	89-98143	59	DS6MC	40*
63-68073	27	89-3A010-B	61	89-68167	57	89-98147	59	DS9MC	44*
63-68075	27	89-3A010-T	61	89-6A010	61	89-98162	59	FDP2	36*
63-68076	27	89-3A010-T-172	61	89-6A010-172	61	89-98163	59	FDP3	38*
63-68142	27	89-3A011	61	89-6A010-B	61	89-98167	59	FDP6	40*
63-68143	27	89-3A014	61	89-6A010-T	61	89-9A010	61	FDP9SS	44
63-68147	27	89-3A019	61	89-6A010-T-172	61	89-9A010-174	61	FH111	36*
63-68162	27	89-3A020	62	89-6A011	61	89-9A010-B	61	FH311	38*
63-68163	27	89-3A020-172	62	89-6A014	61	89-9A010-T	61	FH311-473	38*
63-68167	27	89-3A020-B	62	89-6A019	61	89-9A010-T-174	61	FH611	40*
6H1	40*	89-3A020-T	62	89-6A020	62	89-9A011	61	FH611-473	40*
6H112	40*	89-3A020-T-172	62	89-6A020-172	62	89-9A014	61	H091U1	92*
6H114	40*	89-3A021	62	89-6A020-B	62	89-9A019	61	H091U1-185	150
6H12	40*	89-3A021N	62	89-6A020-T	62	89-9A020	62	H091U12	92*
6H34	40*	89-3A024	62	89-6A020-T-172	62	89-9A020-174	62	H091U12-185	150
6PH1	40*	89-3A026	61*	89-6A021	62	89-9A020-B	62	H091U34	92*
6PH112	40*	89-3A027	28*	89-6A021N	62	89-9A020-T	62	H091U34-185	150
6PH114	40*	89-3A029	62	89-6A024	62	89-9A020-T-174	62	MA1	24
6PH12	40*	89-3A053-080-1	56	89-6A026	61*	89-9A021	62	MA10	44*
6PH34	40*	89-3A053-080-114	56	89-6A027	40*	89-9A021N	62	MA110	44*
6PM622	40*	89-3A053-080-12	56	89-6A029	62	89-9A024	62	MA2	26*
6PM625	40*	89-3A053-080-34	56	89-6A053-080-1	58	89-9A026	61*	MA20	46*
6PM627	40*	89-3A126	56	89-6A053-080-112	58	89-9A027	44*	MA220	46*
6PM629	40*	89-3A219-172	61	89-6A053-080-114	58	89-9A029	62	MA2SS	98
89-34042	55	89-3A229-172	62	89-6A053-080-2	58	89-9A053-080-112	60	MA3	28*
89-34043	55	89-3A523	61	89-6A126	58	89-9A053-080-114	60	MA3SS	102
89-34045	55	89-3A925	62	89-6A219-172	61	89-9A053-080-2	60	MA6	40*
89-34047	55	89-64042	57	89-6A229-172	62	89-9A126	60	MA660	40*
89-34072	55	89-64043	57	89-6A523	61	89-9A219-174	61	MAB6	40*
89-34073	55	89-64045	57	89-6A925	62	89-9A229-174	62	MAFS2	26*
89-34075	55	89-64047	57	89-94042	59	89-9A523	61	MAFS3	28*
89-34076	55	89-64072	57	89-94043	59	89-9A925	62	MB10112	44*
89-34142	55	89-64073	57	89-94045	59	9H1	44*	MB10114	44*

Part Number	Pages	Part Number	Pages	Part Number	Pages	Part Number	Pages	Part Number	Pages
MB102	44*								
MB10212	44*								
MB20112	46*								
MB202	46*								
MB20212	46*								
MB22212	46*								
MB31	24*								
MB3114	28*								
MB3114-601	24								
MB312	28*								
MB312-601	24*								
MB312-NP	150								
MB314-NP	150								
MB31-601	24								
MB31-NP	150								
MB334	28*								
MB334-601	24								
MB334-NP	150								
MB40PFQ-XX	122								
MB40-XX	122								
MB61	40*								
MB6112	40*								
MB6114	40*								
MB62	40*								
MC212	36*								
MC234	36*								
MC31	134								
MC312	134								
MC61	40*								
MC6114	40*								
MC612	40*								
MC634	40*								
MP10	44*								
MP2	36*								
MP3	38*								
MP6	40*								
MS1	24								
MS10	44*								
MS2	26*								
MS20	110								
MS210	140								
MS3	28*								
MS6	40*								
MSPN	24*								
MSPN-185	150								
NT100	44*								
NT110	44*								
NT120	44*								
NT200	46*								
NT210	46*								
NT220	46*								